



CST20N06 N-Ch 60V Fast Switching MOSFETs

- ★ 100% EAS Guaranteed
- ★ Green Device Available
- ★ Super Low Gate Charge
- ★ Excellent CdV/dt effect decline
- ★ Advanced high cell density Trench technology

CST20N06 Product Summary



BVDSS	RDSON	ID
60V	25mΩ	20A

CST20N06 Description

The CST20N06 is the high cell density trenched N-ch MOSFETs, which provide excellent RDSON and gate charge for most of the synchronous buck converter applications. The CST20N06 meet the RoHS and Green Product requirement, 100% EAS guaranteed with full function reliability approved.

CST20N06 TO252 Pin Configuration

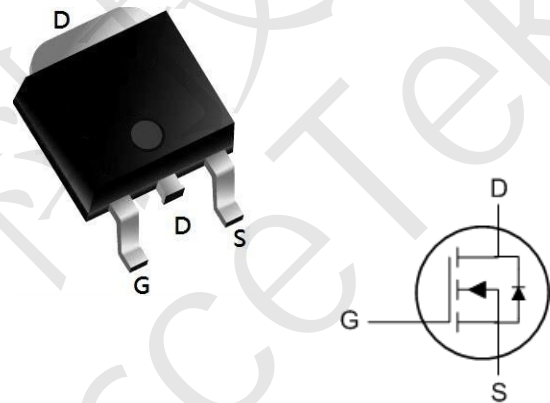

CST20N06 Absolute Maximum Ratings (T_C=25°C unless otherwise specified)

Symbol	Parameter	Max.	Units
V _{DSS}	Drain-Source Voltage	60	V
V _{GSS}	Gate-Source Voltage	±30	V
I _D	Continuous Drain Current	T _C = 25°C	20
		T _C = 100°C	10
I _{DM}	Pulsed Drain Current ^{note1}	80	A
EAS	Single Pulsed Avalanche Energy ^{note2}	39	mJ
P _D	Power Dissipation	T _C = 25°C	41.7
R _{θJC}	Thermal Resistance, Junction to Case	50	°C/W
T _J , T _{STG}	Operating and Storage Temperature Range	-55 to +175	°C



CST20N06 N-Ch 60V Fast Switching MOSFETs

CST20N06 Electrical Characteristics ($T_J = 25^\circ\text{C}$, unless otherwise noted)

Parameter	Symbol	Test Conditions	Min.	Typ.	Max.	Unit	
Static Characteristics							
Drain-Source Breakdown Voltage	$V_{(BR)DSS}$	$V_{GS} = 0V, I_D = 250\mu A$	60	-	-	V	
Gate-Body Leakage Current	I_{GSS}	$V_{DS} = 0V, V_{GS} = \pm 20V$	-	-	± 100	nA	
Zero Gate Voltage Drain Current	I_{DSS}	$V_{DS} = 60V, V_{GS} = 0V$	$T_J = 25^\circ\text{C}$	-	-	1	μA
			$T_J = 100^\circ\text{C}$	-	-	100	
Gate-Threshold Voltage	$V_{GS(th)}$	$V_{DS} = V_{GS}, I_D = 250\mu A$	1.2	1.7	2.5	V	
Drain-Source on-Resistance ⁴	$R_{DS(on)}$	$V_{GS} = 10V, I_D = 10A$	-	25	32	m Ω	
		$V_{GS} = 4.5V, I_D = 5A$	-	31.5	40		
Forward Transconductance ⁴	g_{fs}	$V_{DS} = 5V, I_D = 10A$	-	15.5	-	S	
Dynamic Characteristics⁵							
Input Capacitance	C_{iss}	$V_{DS} = 30V, V_{GS} = 0V, f = 1\text{MHz}$	-	1355	-	pF	
Output Capacitance	C_{oss}		-	60	-		
Reverse Transfer Capacitance	C_{rss}		-	49	-		
Gate Resistance	R_G	$f = 1\text{MHz}$	-	1.2	-	Ω	
Switching Characteristics⁵							
Total Gate Charge	Q_g	$V_{GS} = 10V, V_{DD} = 30V, I_D = 10A$	-	22	-	nC	
Gate-Source Charge	Q_{gs}		-	4.2	-		
Gate-Drain Charge	Q_{gd}		-	6.9	-		
Turn-on Delay Time	$t_{d(on)}$	$V_{GS} = 10V, V_{DD} = 30V, R_G = 3\Omega, I_D = 10A$	-	6.4	-	ns	
Rise Time	t_r		-	15.3	-		
Turn-off Delay Time	$t_{d(off)}$		-	25	-		
Fall Time	t_f		-	7.6	-		
Body Diode Reverse Recovery Time	t_{rr}	$I_F = 10A, dI_F/dt = 100A/\mu s$	-	26	-	ns	
Body Diode Reverse Recovery Charge	Q_{rr}		-	45	-	nC	
Drain-Source Body Diode Characteristics							
Diode Forward Voltage ⁴	V_{SD}	$I_S = 10A, V_{GS} = 0V$	-	-	1.2	V	
Continuous Source Current	I_S	$T_C = 25^\circ\text{C}$	-	-	20	A	

Notes:

1. Repetitive rating, pulse width limited by junction temperature $T_{J(MAX)} = 150^\circ\text{C}$
2. The EAS data shows Max. rating . The test condition is $V_{DD} = 25V, V_{GS} = 10V, L = 0.4\text{mH}, I_{AS} = 14A$
3. The data tested by surface mounted on a 1 inch² FR-4 board with 2OZ copper, The value in any given application depends on the user's specific board design.
4. The data tested by pulsed , pulse width $\leq 300\mu s$, duty cycle $\leq 2\%$.
5. This value is guaranteed by design hence it is not included in the production test.



CST20N06 Typical Characteristics

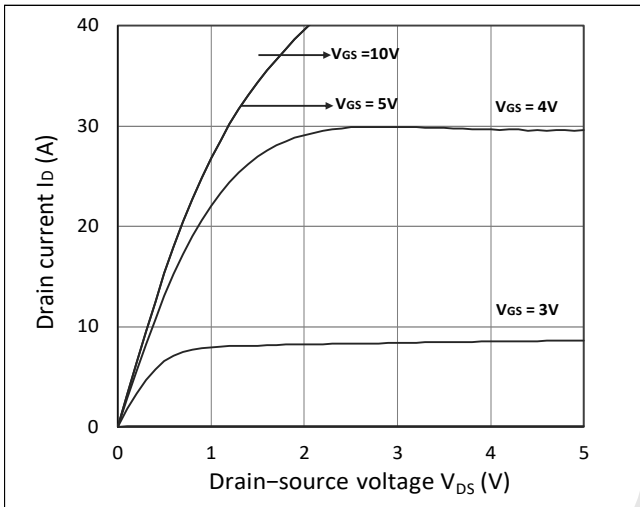

Figure 1. Output Characteristics

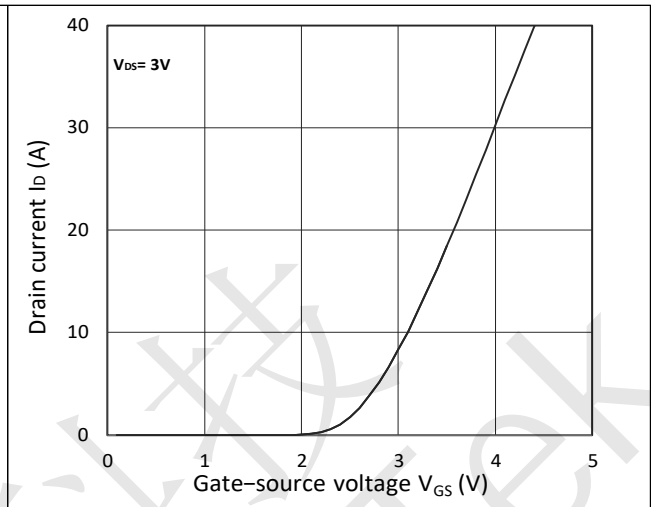

Figure 2. Transfer Characteristics

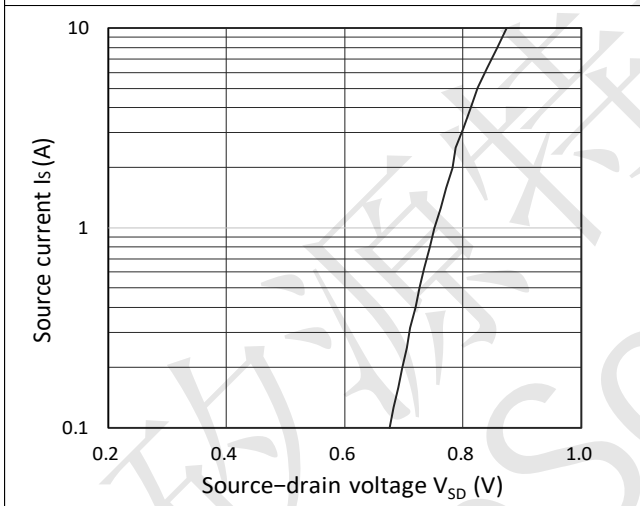

Figure 3. Forward Characteristics of Reverse

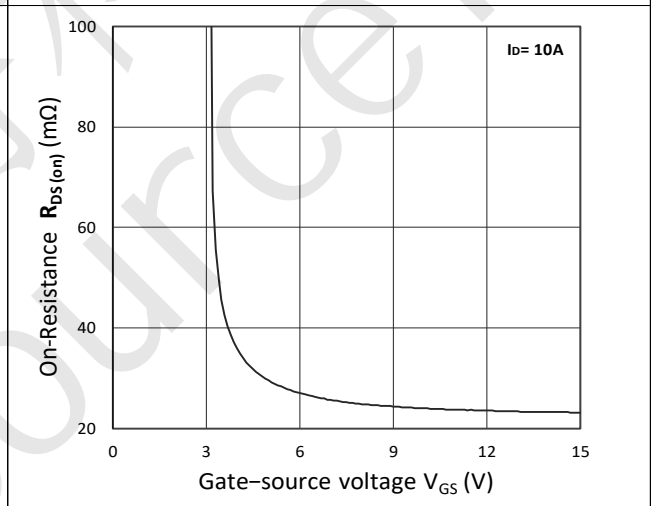

Figure 4. $R_{DS(ON)}$ vs. V_{GS}

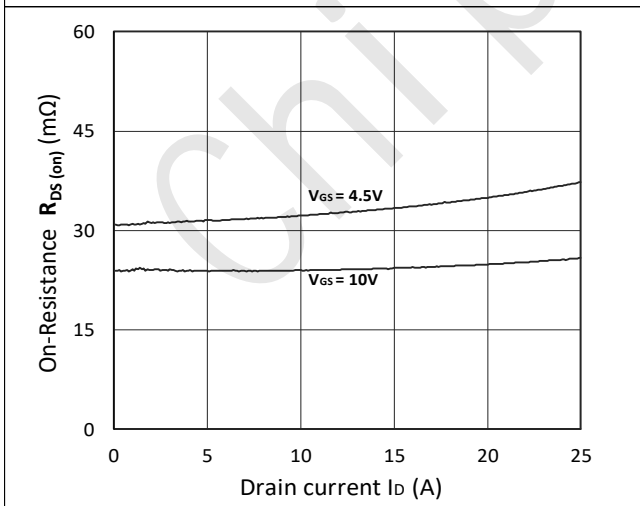

Figure 5. $R_{DS(ON)}$ vs. I_D

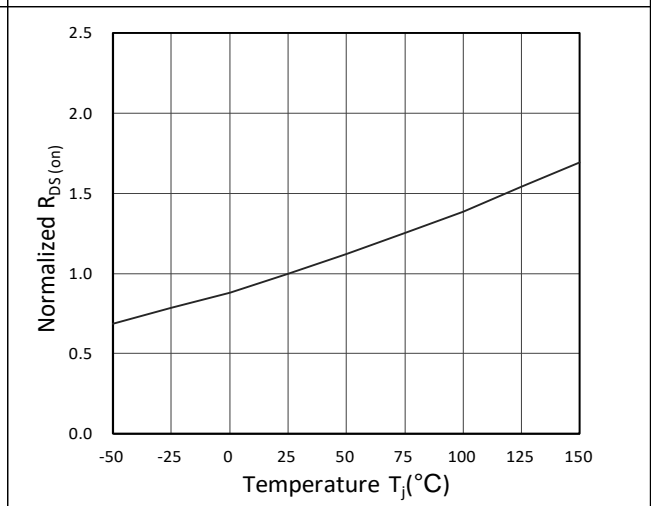

Figure 6. Normalized $R_{DS(ON)}$ vs. Temperature



CST20N06 N-Ch 60V Fast Switching MOSFETs

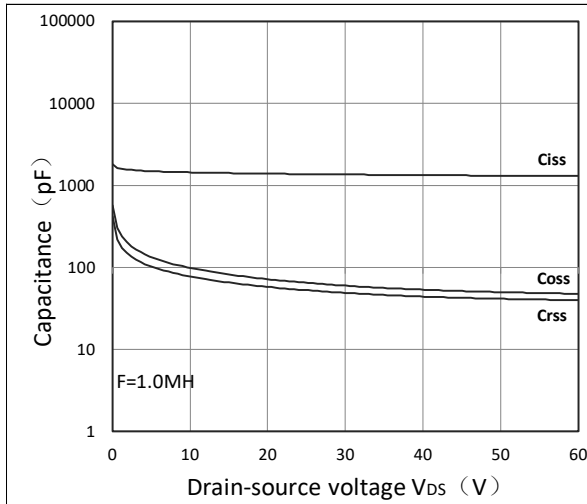

Figure 7. Capacitance Characteristics

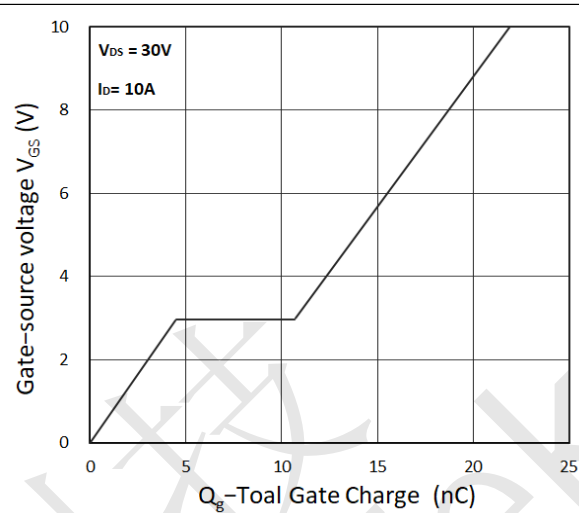

Figure 8. Gate Charge Characteristics

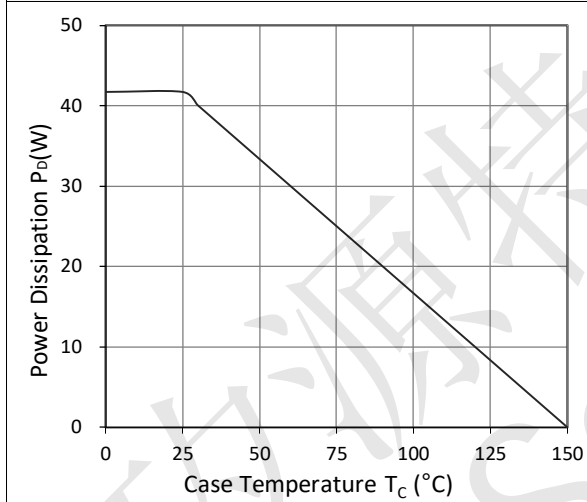

Figure 9. Power Dissipation

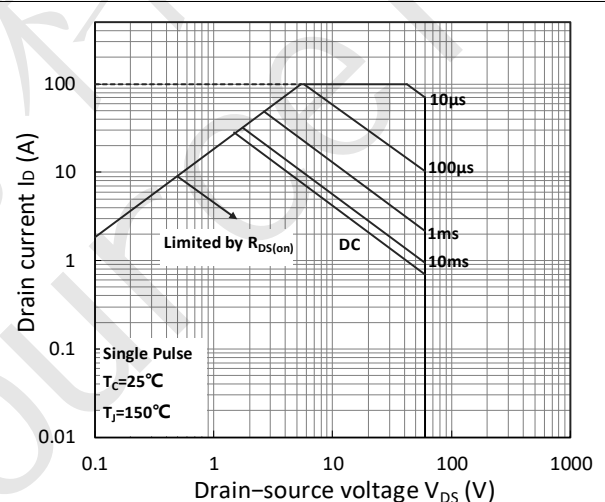

Figure 10. Safe Operating Area

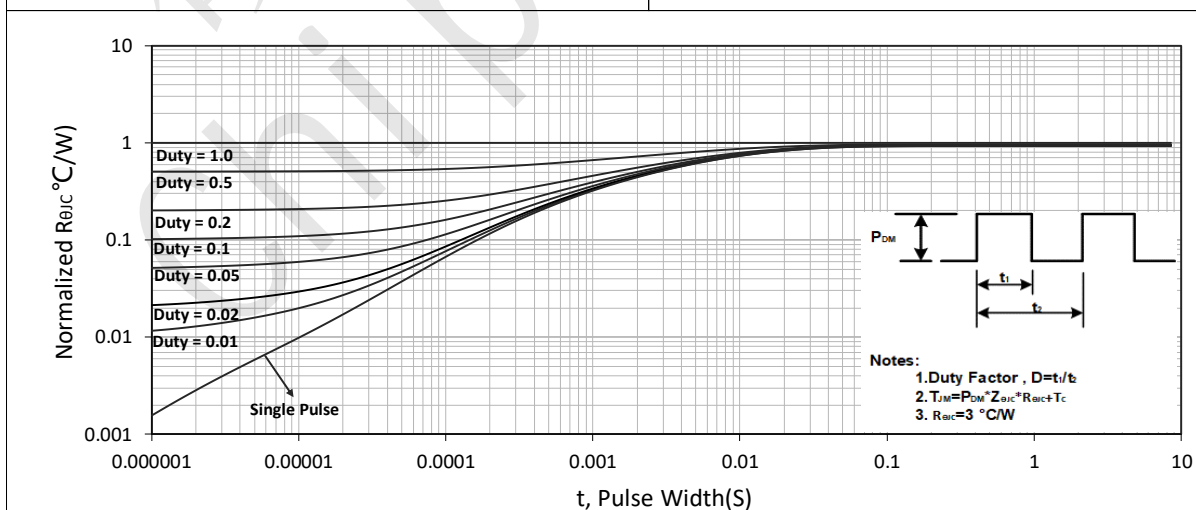
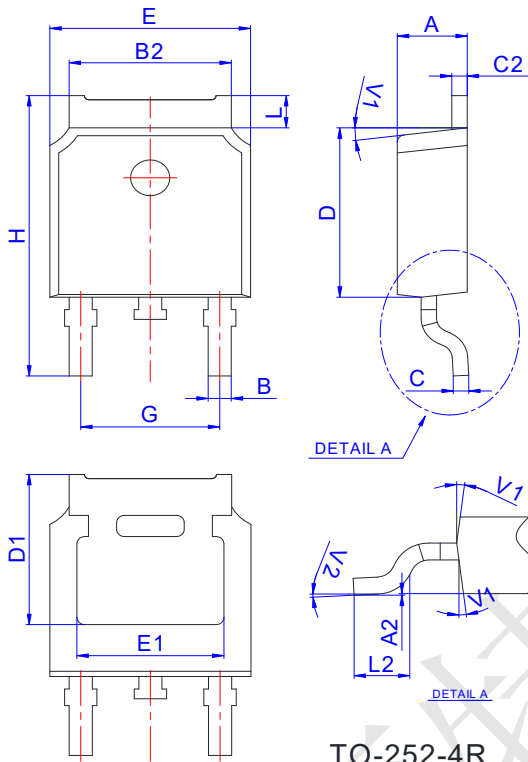

Figure 11. Normalized Maximum Transient Thermal Impedance



CST20N06 N-Ch 60V Fast Switching MOSFETs

CST20N06 Package Mechanical Data-TO-252



Ref.	Dimensions					
	Millimeters			Inches		
	Min.	Typ.	Max.	Min.	Typ.	Max.
A	2.10		2.50	0.083		0.098
A2	0		0.10	0		0.004
B	0.66		0.86	0.026		0.034
B2	5.18		5.48	0.202		0.216
C	0.40		0.60	0.016		0.024
C2	0.44		0.58	0.017		0.023
D	5.90		6.30	0.232		0.248
D1	5.30REF			0.209REF		
E	6.40		6.80	0.252		0.268
E1	4.63			0.182		
G	4.47		4.67	0.176		0.184
H	9.50		10.70	0.374		0.421
L	1.09		1.21	0.043		0.048
L2	1.35		1.65	0.053		0.065
V1		7°		7°		
V2	0°		6°	0°		6°

CST20N06 Reel Specification-TO-252

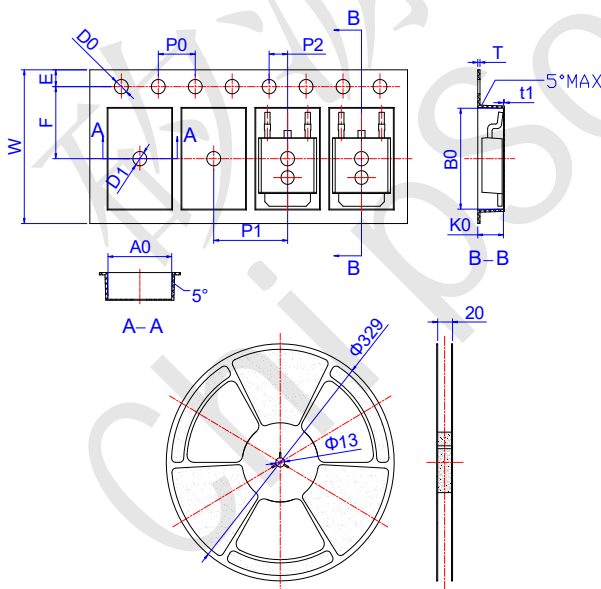

Ref.	Dimensions					
	Millimeters			Inches		
	Min.	Typ.	Max.	Min.	Typ.	Max.
W	15.90	16.00	16.10	0.626	0.630	0.634
E	1.65	1.75	1.85	0.065	0.069	0.073
F	7.40	7.50	7.60	0.291	0.295	0.299
D0	1.40	1.50	1.60	0.055	0.059	0.063
D1	1.40	1.50	1.60	0.055	0.059	0.063
P0	3.90	4.00	4.10	0.154	0.157	0.161
P1	7.90	8.00	8.10	0.311	0.315	0.319
P2	1.90	2.00	2.10	0.075	0.079	0.083
A0	6.85	6.90	7.00	0.270	0.271	0.276
B0	10.45	10.50	10.60	0.411	0.413	0.417
K0	2.68	2.78	2.88	0.105	0.109	0.113
T	0.24		0.27	0.009		0.011
t1	0.10			0.004		
10P0	39.80	40.00	40.20	1.567	1.575	1.583