



### CST3419A P-Ch 30V Fast Switching MOSFETs

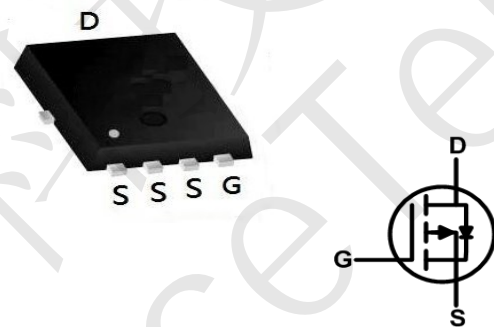
- ★ 100% EAS Guaranteed
- ★ Green Device Available
- ★ Super Low Gate Charge
- ★ Excellent CdV/dt effect decline
- ★ Advanced high cell density Trench technology

#### CST3419A Product Summary



BVDSS	RDS(on)	ID
-30V	8.5 mΩ	-55A

#### CST3419A PDFN3333-8L Pin Configuration



#### CST3419A Description

The CST3419A is the highest performance trench P-ch MOSFETs with extreme high cell density, which provide excellent RDS(on) and gate charge for most of the synchronous buck converter applications. The CST3419A meet the RoHS and Green Product requirement, 100% EAS guaranteed with full function reliability approved.

#### CST3419A Absolute Maximum Ratings (T<sub>C</sub>=25°C unless otherwise specified)

Symbol	Parameter	Max.	Units
V <sub>DSS</sub>	Drain-Source Voltage	-30	V
V <sub>GSS</sub>	Gate-Source Voltage	±20	V
I <sub>D</sub>	Continuous Drain Current	T <sub>C</sub> = 25°C	-55
		T <sub>C</sub> = 100°C	-23
I <sub>DM</sub>	Pulsed Drain Current <sup>note1</sup>	-140	A
E <sub>AS</sub>	Single Pulsed Avalanche Energy <sup>note2</sup>	78.8	mJ
P <sub>D</sub>	Power Dissipation	T <sub>C</sub> = 25°C	21.5
R <sub>θJC</sub>	Thermal Resistance, Junction to Case	5.8	°C/W
T <sub>J</sub> , T <sub>STG</sub>	Operating and Storage Temperature Range	-55 to +150	°C



### CST3419A P-Ch 30V Fast Switching MOSFETs

#### CST3419A Electrical Characteristics (T<sub>J</sub>=25°C unless otherwise specified)

Symbol	Parameter	Test Condition	Min.	Typ.	Max.	Units
<b>Off Characteristic</b>						
V <sub>(BR)DSS</sub>	Drain-Source Breakdown Voltage	V <sub>GS</sub> =0V, I <sub>D</sub> = -250μA	-30	-	-	V
I <sub>DSS</sub>	Zero Gate Voltage Drain Current	V <sub>DS</sub> = -30V, V <sub>GS</sub> = 0V,	-	-	-1	μA
I <sub>GSS</sub>	Gate to Body Leakage Current	V <sub>DS</sub> =0V, V <sub>GS</sub> = ±20V	-	-	±100	nA
<b>On Characteristics</b>						
V <sub>GS(th)</sub>	Gate Threshold Voltage	V <sub>DS</sub> = V <sub>GS</sub> , I <sub>D</sub> = -250μA	-1.0	-1.5	-2.5	V
R <sub>DS(on)</sub>	Static Drain-Source on-Resistance <small>note3</small>	V <sub>GS</sub> = -10V, I <sub>D</sub> = -12A	-	8.5	11	mΩ
		V <sub>GS</sub> = -4.5V, I <sub>D</sub> = -8A	-	13	18	
<b>Dynamic Characteristics</b>						
C <sub>iss</sub>	Input Capacitance	V <sub>DS</sub> = -15V, V <sub>GS</sub> = 0V, f = 1.0MHz	-	2800	-	pF
C <sub>oss</sub>	Output Capacitance		-	346	-	pF
C <sub>rss</sub>	Reverse Transfer Capacitance		-	319	-	pF
Q <sub>g</sub>	Total Gate Charge	V <sub>DS</sub> = -15V, I <sub>D</sub> = -20A, V <sub>GS</sub> = -10V	-	30	-	nC
Q <sub>gs</sub>	Gate-Source Charge		-	5.3	-	nC
Q <sub>gd</sub>	Gate-Drain("Miller") Charge		-	7.6	-	nC
<b>Switching Characteristics</b>						
t <sub>d(on)</sub>	Turn-on Delay Time	V <sub>DD</sub> = -15V, I <sub>D</sub> = -20A, V <sub>GS</sub> =-10V, R <sub>GEN</sub> =2.5Ω	-	14	-	ns
t <sub>r</sub>	Turn-on Rise Time		-	20	-	ns
t <sub>d(off)</sub>	Turn-off Delay Time		-	95	-	ns
t <sub>f</sub>	Turn-off Fall Time		-	65	-	ns
<b>Drain-Source Diode Characteristics and Maximum Ratings</b>						
I <sub>S</sub>	Maximum Continuous Drain to Source Diode Forward Current		-	-	-55	A
I <sub>SM</sub>	Maximum Pulsed Drain to Source Diode Forward Current		-	-	-140	A
V <sub>SD</sub>	Drain to Source Diode Forward Voltage	V <sub>GS</sub> = 0V, I <sub>S</sub> = -35A	-	-0.8	-1.2	V

Notes:1. Repetitive Rating: Pulse Width Limited by Maximum Junction Temperature

2. EAS condition: T<sub>J</sub>= 25°C, V<sub>DD</sub>= -20V, V<sub>G</sub>= -10V, L= 0.5mH, R<sub>G</sub>= 25 Ω, I<sub>AS</sub>= -17A

3. Pulse Test: Pulse Width≤300μs, Duty Cycle≤2%



## CST3419A Typical Performance Characteristics

Figure 1: Output Characteristics

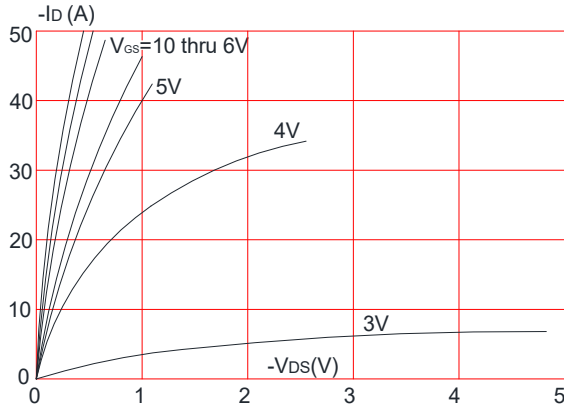


Figure 2: Typical Transfer Characteristics

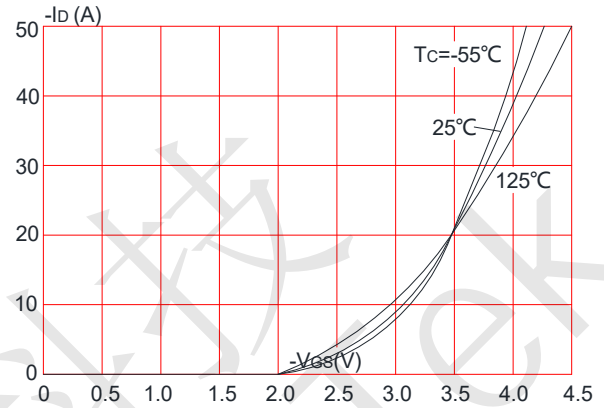


Figure 3: On-resistance vs. Drain Current

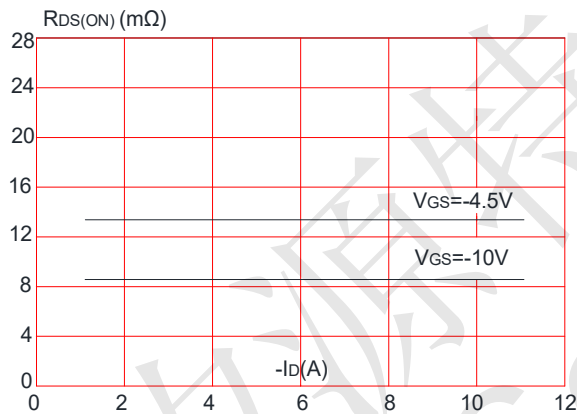


Figure 4: Body Diode Characteristics

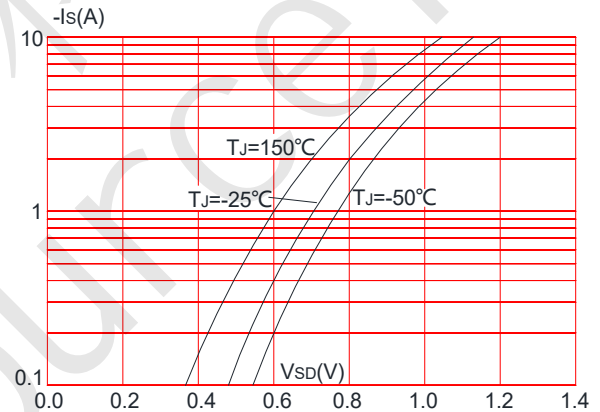


Figure 5: Gate Charge Characteristics

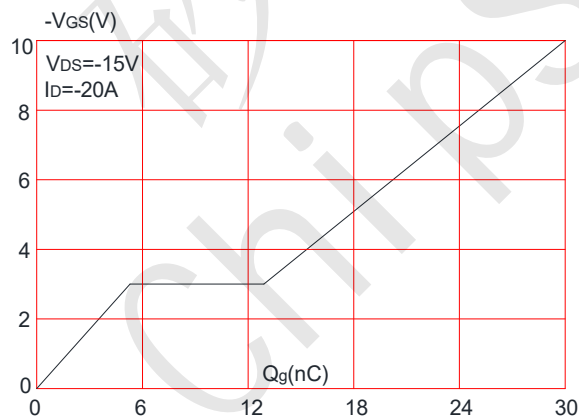
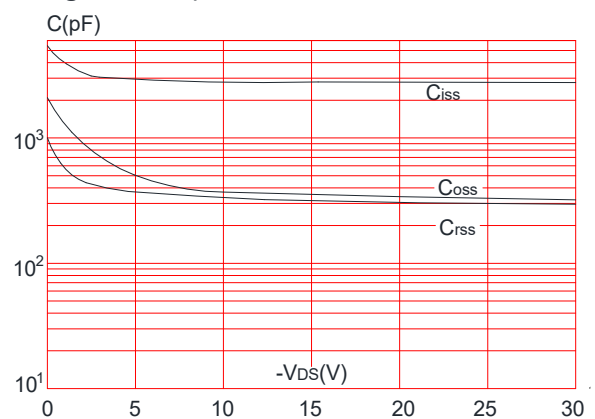


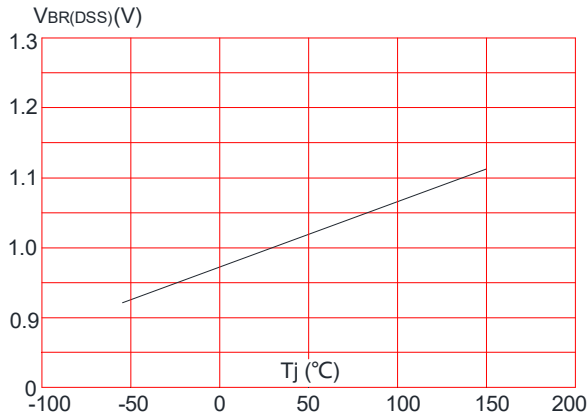
Figure 6: Capacitance Characteristics



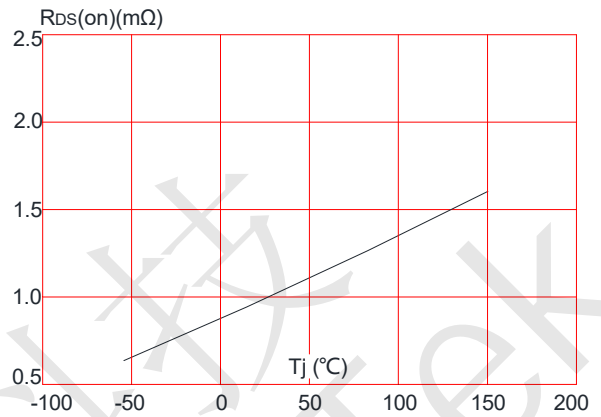


### CST3419A P-Ch 30V Fast Switching MOSFETs

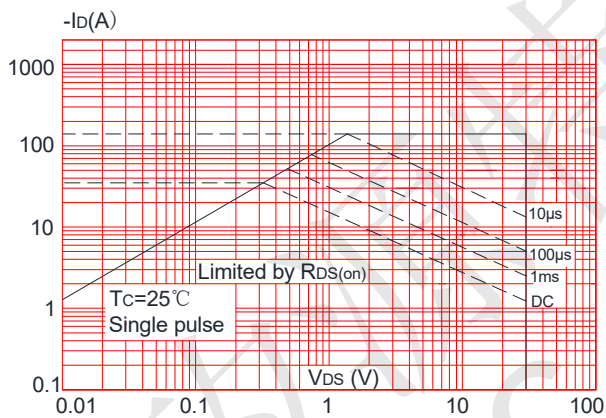
**Figure 7:** Normalized Breakdown Voltage vs. Junction Temperature



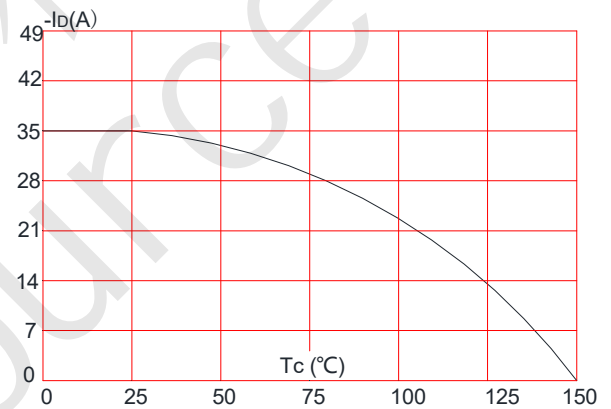
**Figure 8:** Normalized on Resistance vs. Junction Temperature



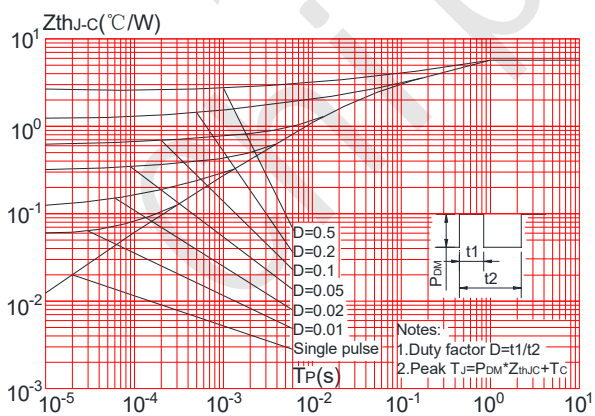
**Figure 9:** Maximum Safe Operating Area



**Figure 10:** Maximum Continuous Drain Current vs. Case Temperature

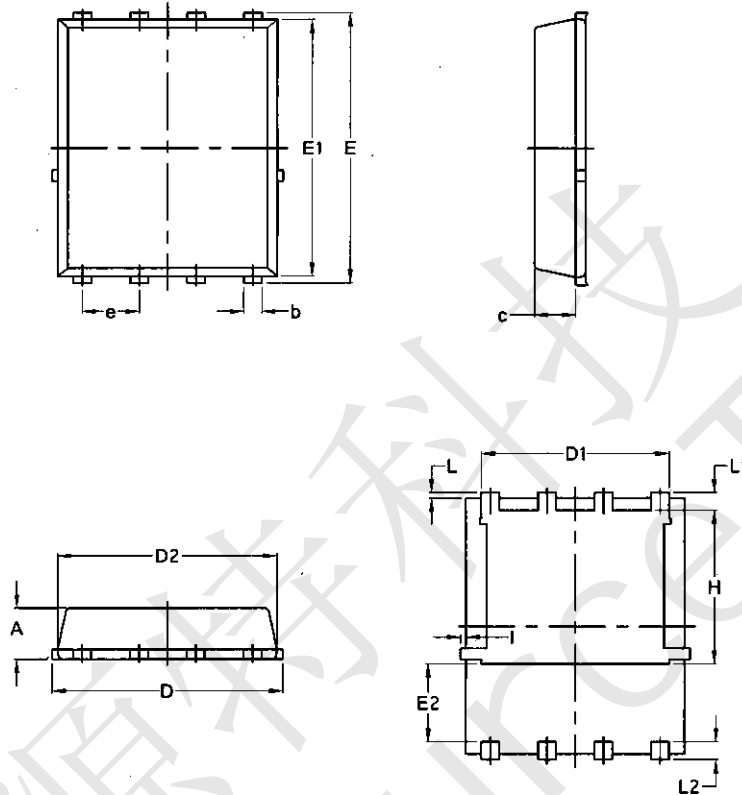


**Figure.11:** Maximum Effective Transient Thermal Impedance, Junction-to-Case





CST3419A Package Mechanical Data-PDFN3333-8L-Single



COMMON DIMENSIONS

(UNITS OF MEASURE=MILLIMETER)

SYMBOL	MIN	NOM	MAX
A	0.70	0.80	0.90
A1	0.00	0.03	0.05
b	0.24	0.30	0.35
c	0.10	0.15	0.20
D	3.25	3.32	3.40
D1	3.05	3.15	3.25
D2	2.40	2.50	2.60
E	3.00	3.10	3.20
E1	1.35	1.45	1.55
e	0.65 BSC.		
H	3.20	3.30	3.40
L	0.30	0.40	0.50
L1	0.10	0.15	0.20
L2	1.13 REF.		