

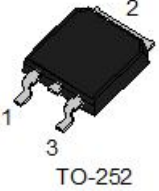
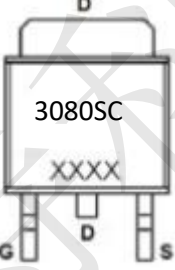
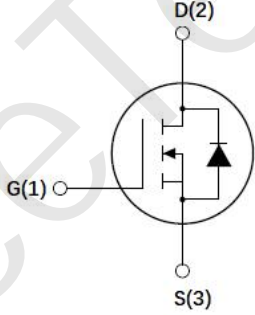

FM3080SC N-Channel Trench Power MOSFET

FM3080SC Description

<p>Features</p> <ul style="list-style-type: none">• 30V,65A• $R_{DS(ON)}=5.4m\Omega$ (Typ.) @ $V_{GS}=10V$• $R_{DS(ON)}=7.8m\Omega$ (Typ.) @ $V_{GS}=4.5V$• Advanced Trench Technology• Provide Excellent $R_{DS(ON)}$ and Low Gate Charge	<p>Application</p> <ul style="list-style-type: none">• Load Switch• PWM Application
<p>Package</p>   	

FM3080SC Absolute Maximum Ratings ($T_c=25^\circ C$ unless otherwise specified)

Symbol	Parameter	Value	Units	
V_{DSS}	Drain-Source Voltage	30	V	
V_{GSS}	Gate-Source Voltage	± 20	V	
I_D	Continuous Drain Current	$T_c = 25^\circ C$	65	A
		$T_c = 100^\circ C$	41	A
I_{DM}	Pulsed Drain Current ^{note1}	197	A	
E_{AS}	Single Pulsed Avalanche Energy ^{note2}	144	mJ	
P_D	Power Dissipation	$T_C = 25^\circ C$	32	W
$R_{\theta JC}$	Thermal Resistance, Junction to Case	3.9	$^\circ C/W$	
T_J, T_{STG}	Operating and Storage Temperature Range	-55 to +150	$^\circ C$	



FM3080SC N-Channel Trench Power MOSFET

FM3080SC Electrical Characteristics (T_C=25°C unless otherwise specified)

Symbol	Parameter	Test Condition	Min.	Typ.	Max.	Units
Off Characteristic						
V _{(BR)DSS}	Drain-Source Breakdown Voltage	V _{GS} =0V, I _D =250μA	30	-	-	V
I _{DSS}	Zero Gate Voltage Drain Current	V _{DS} =30V, V _{GS} =0V,	-	-	1.0	μA
I _{GSS}	Gate to Body Leakage Current	V _{DS} =0V, V _{GS} =±20V	-	-	±100	nA
On Characteristics						
V _{GS(th)}	Gate Threshold Voltage	V _{DS} =V _{GS} , I _D =250μA	1	1.6	2	V
R _{DS(on)}	Static Drain-Source on-Resistance <small>note3</small>	V _{GS} =10V, I _D =20A	-	5.4	6.5	mΩ
		V _{GS} =4.5V, I _D =20A	-	7.8	9.4	
g _{FS}	Forward Transconductance	V _{DS} =5V, I _D =20A	-	64	-	S
Dynamic Characteristics						
C _{iss}	Input Capacitance	V _{DS} =15V, V _{GS} =0V, f=1.0MHz	-	1282	-	pF
C _{oss}	Output Capacitance		-	192	-	pF
C _{rss}	Reverse Transfer Capacitance		-	177	-	pF
R _g	Gate resistance		-	2.1	-	Ω
Switching Characteristics						
Q _g	Total Gate Charge	V _{DS} =15V, I _D =20A, V _{GS} =10V	-	27.1	-	nC
Q _{gs}	Gate-Source Charge		-	3.8	-	nC
Q _{gd}	Gate-Drain("Miller") Charge		-	6.8	-	nC
t _{d(on)}	Turn-on Delay Time	V _{DS} =15V, V _{GS} =10V RL=0.75Ω, R _{GEN} =3Ω,	-	10.5	-	ns
t _r	Turn-on Rise Time		-	60	-	ns
t _{d(off)}	Turn-off Delay Time		-	24.5	-	ns
t _f	Turn-off Fall Time		-	13.5	-	ns
Drain-Source Diode Characteristics and Maximum Ratings						
I _S	Maximum Continuous Drain to Source Diode Forward Current		-	-	65	A
I _{SM}	Maximum Pulsed Drain to Source Diode Forward Current		-	-	197	A
V _{SD}	Drain to Source Diode Forward Voltage	V _{GS} =0V, I _S =30A	-	-	1.2	V

Notes: 1. Repetitive Rating: Pulse Width Limited by Maximum Junction Temperature

2. EAS condition: T_J=25°C, V_{DD}=30V, V_G=10V, R_G=25Ω, L=0.5mH

3. Pulse Test: Pulse Width≤300μs, Duty Cycle≤0.5%



FM3080SC N-Channel Trench Power MOSFET

FM3080SC Typical Performance Characteristics

Figure 1: On-Region Characteristics

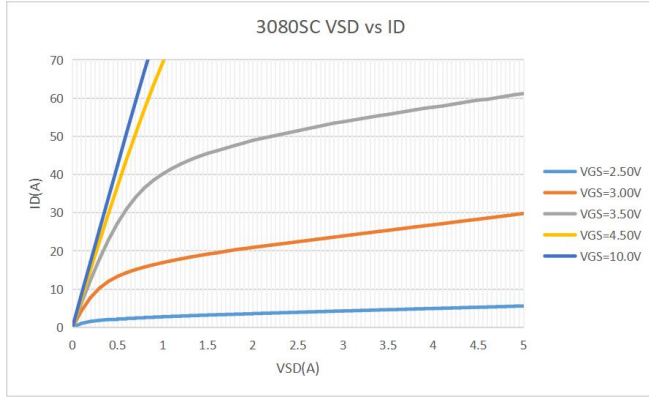

Figure 2: Transfer Characteristics

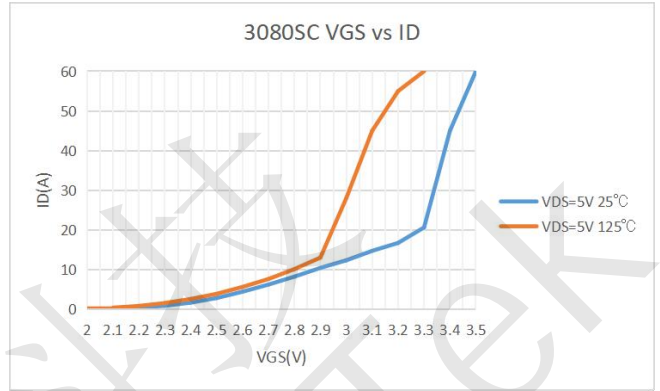

Figure 3: On-resistance vs. Drain Current and Gate Voltage

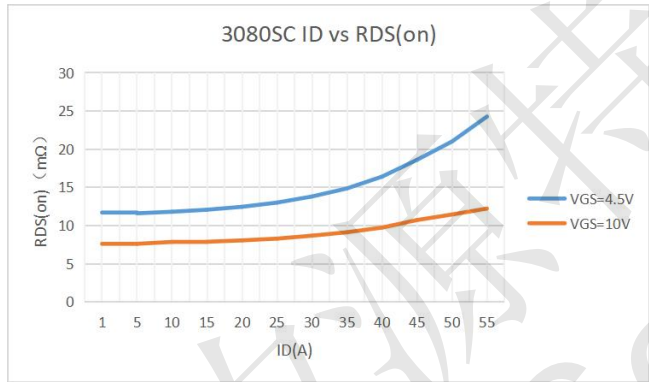

Figure 4: On-Resistance vs. Gate-Source Voltage

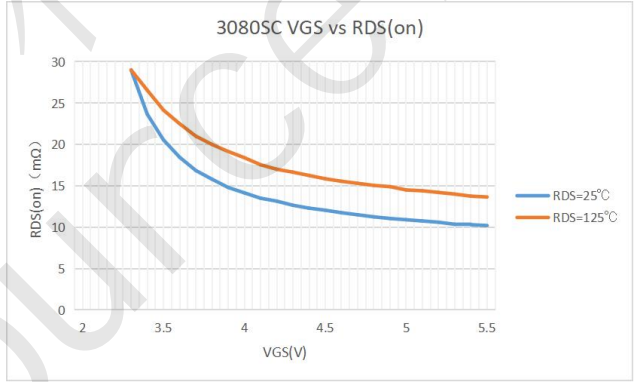

Figure 5: On-Resistance vs. Junction Temperature

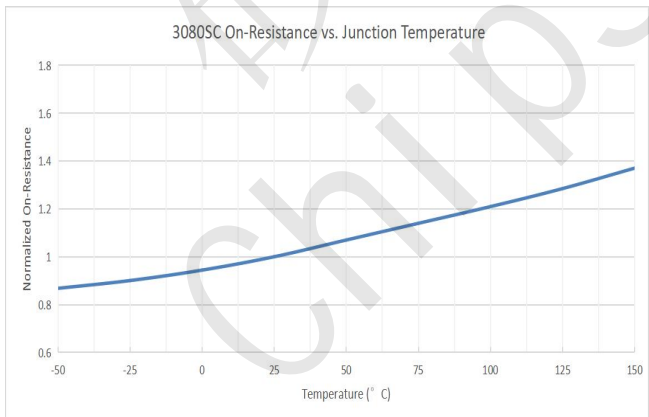
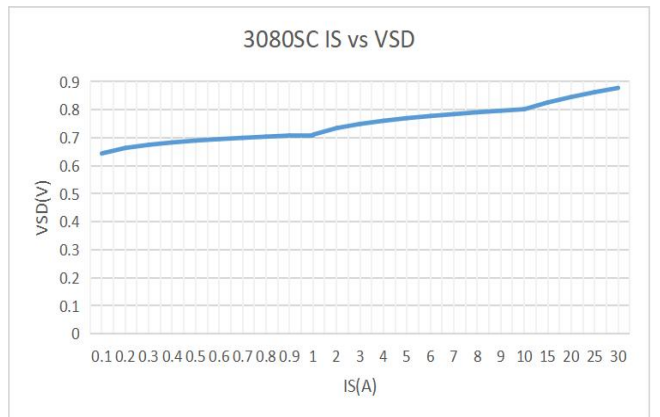

Figure 6: Body-Diode Characteristics





FM3080SC N-Channel Trench Power MOSFET

FM3080SC Typical Performance Characteristics

Figure7: Capacitance Characteristics C(pF)

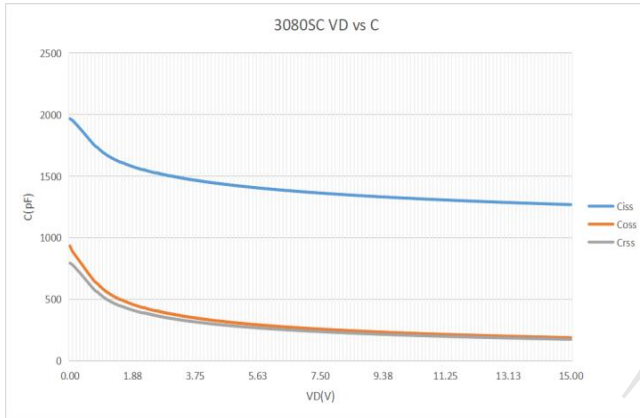

Figure 8: Current De-rating

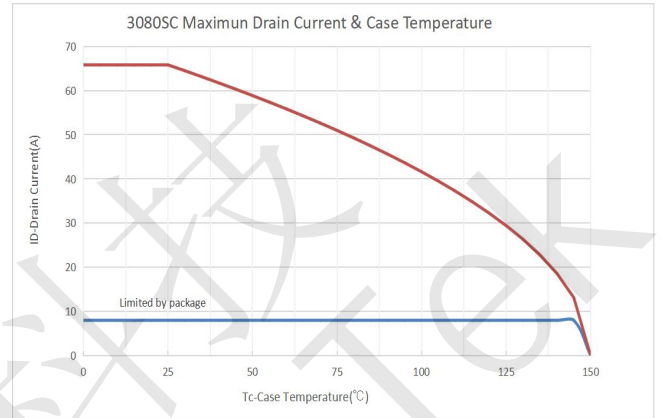
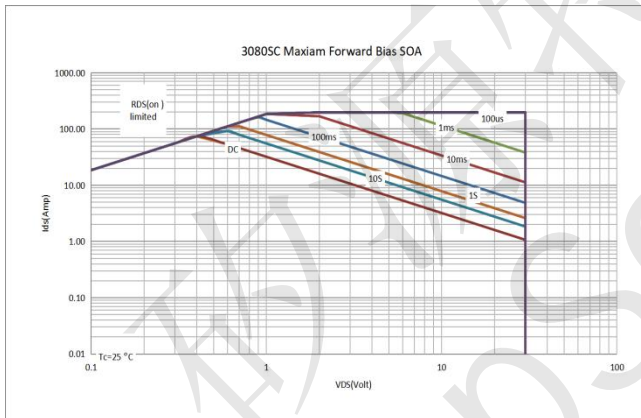

Figure9: Maximum Forward Biased Safe Operating Area





FM3080SC N-Channel Trench Power MOSFET

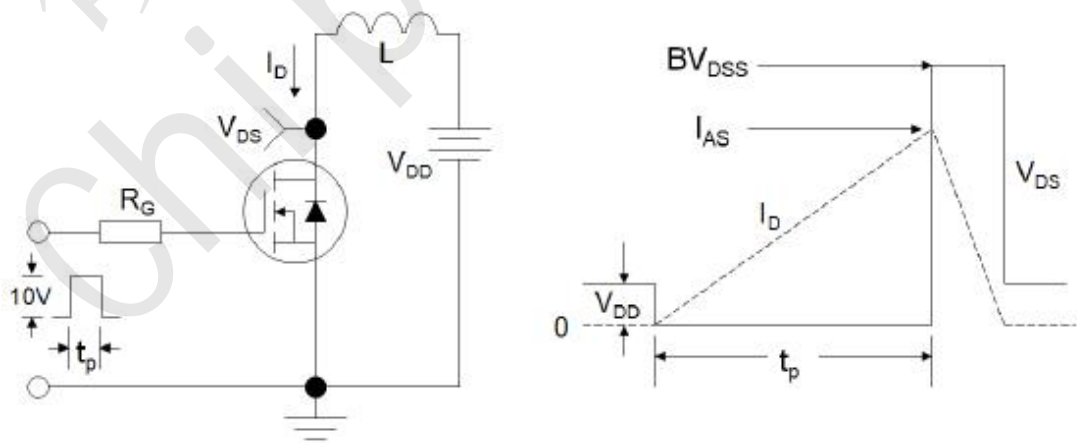
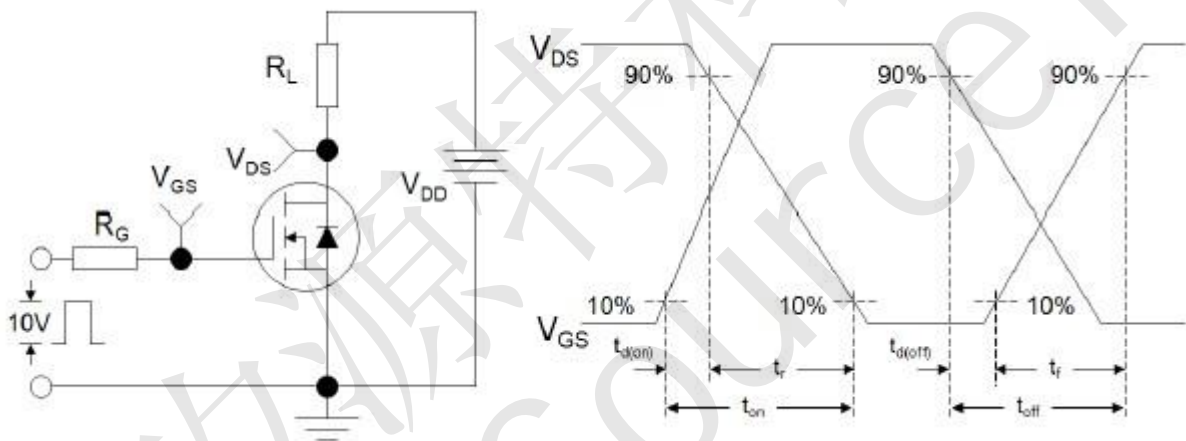
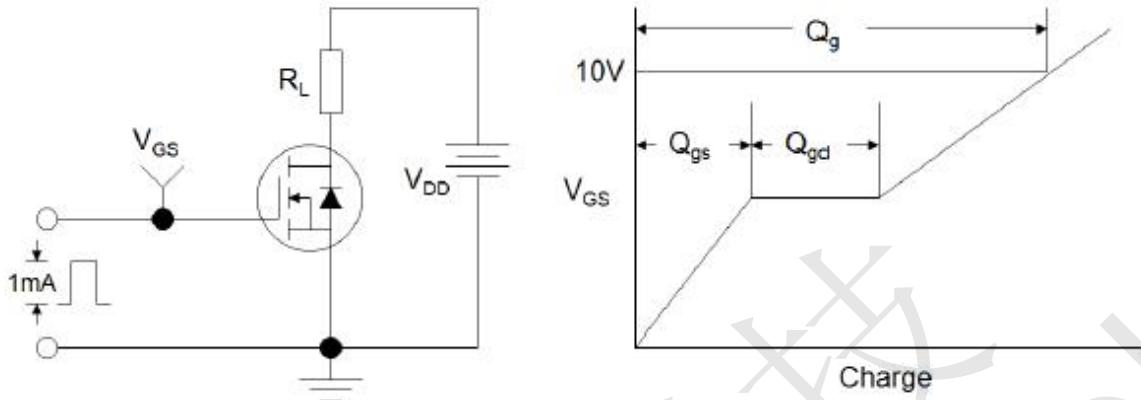
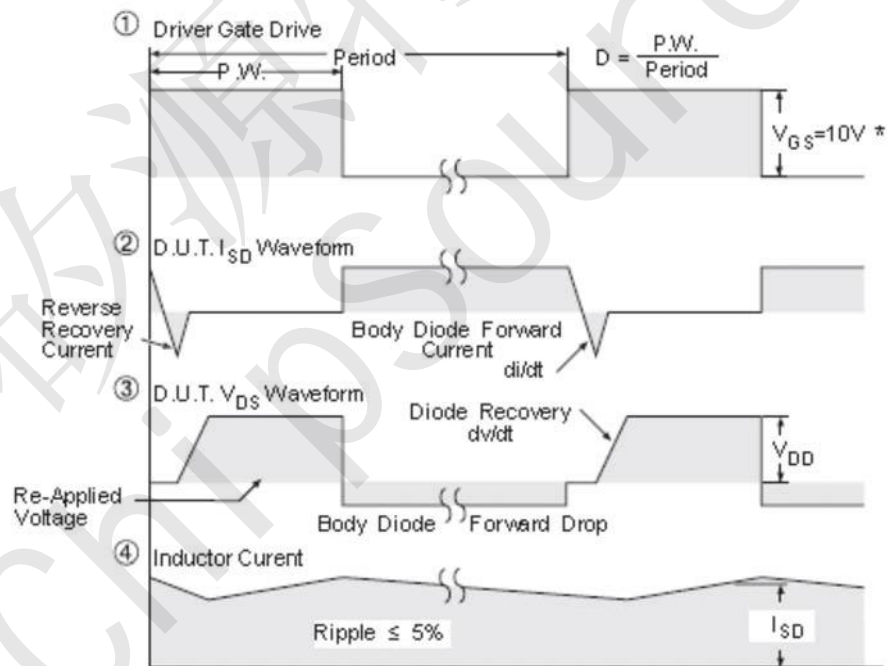
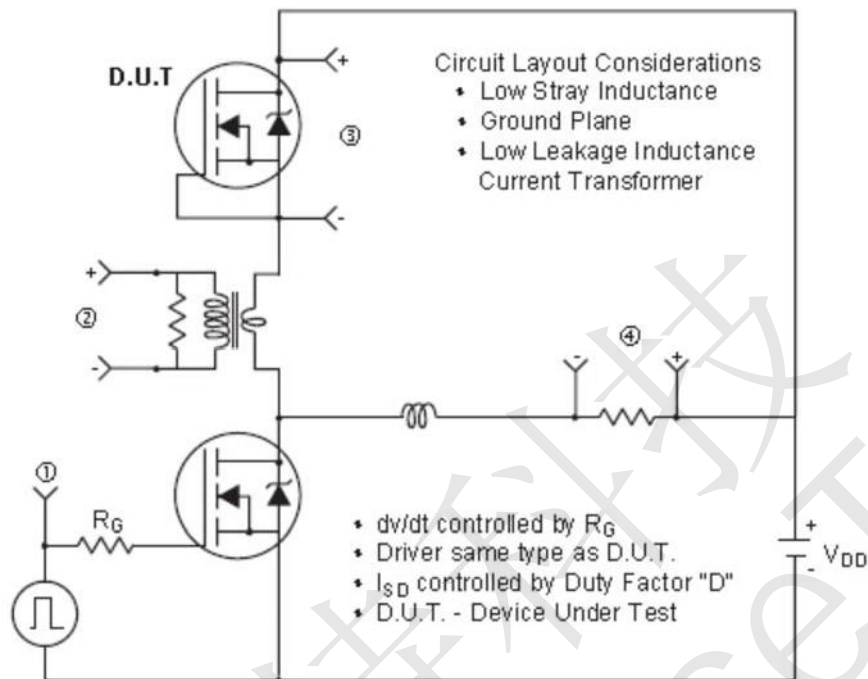

Figure 3: Unclamped Inductive Switching Test Circuit & Waveforms



FM3080SC N-Channel Trench Power MOSFET



* $V_{GS} = 5V$ for Logic Level Devices

Figure 4: Peak Diode Recovery dv/dt Test Circuit & Waveforms (For N-channel)



FM3080SC N-Channel Trench Power MOSFET

FM3080SC TO-252 Package Information

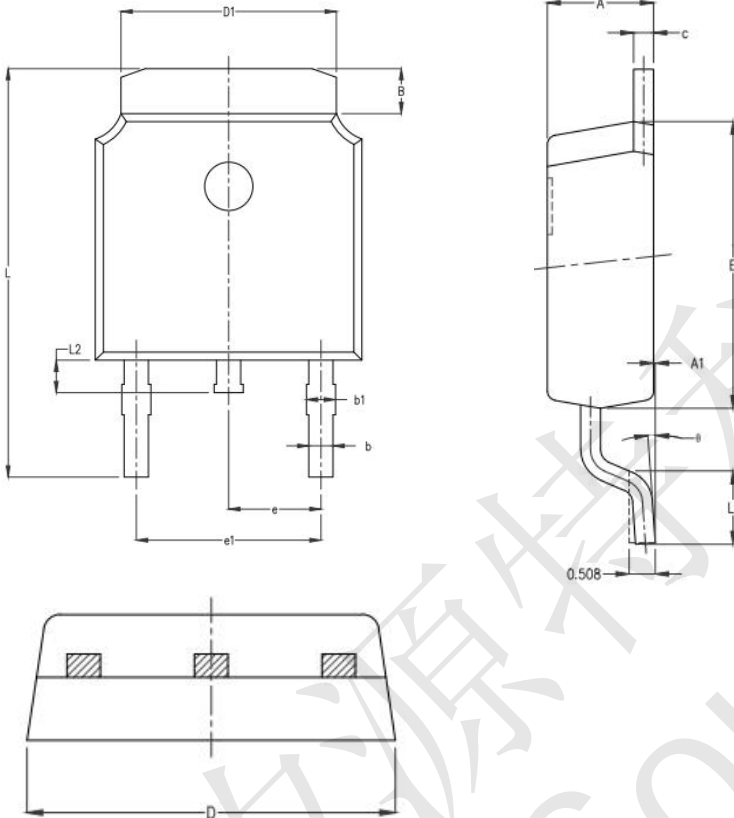

SYMBOL	MILLIMETER		
	MIN	NOM	MAX
A	2.15	2.25	2.35
A1	0.00	0.06	0.12
B	0.96	1.11	1.26
b	0.59	0.69	0.79
b1	0.69	0.81	0.93
c	0.34	0.42	0.50
D	6.45	6.60	6.75
D1	5.23	5.33	5.43
E	5.95	6.10	6.25
e	2.286TYP.		
e1	4.47	4.57	4.67
L	9.90	10.10	10.30
L1	1.40	1.55	1.70
L2	0.60	0.80	1.00
θ	0°	4°	8°