



# 500V N-Channel Planar MOSFET

## MOSFET

Metal Oxide Semiconductor Field Effect Transistor

## 500V N-Channel Planar MOSFET

500V N-Channel Planar MOSFET Power Transistor


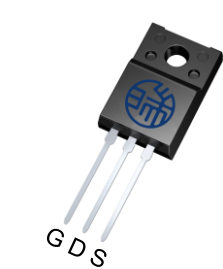

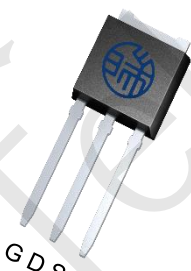
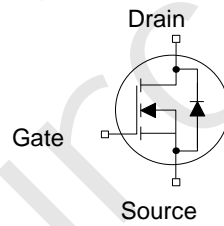

## HRH5N50BDNx Data Sheet

Rev. 2023 V1.1

矽源特科技  
ChipSourceTek



### 500V N-Channel Planar MOSFET

<p><b>HRH5N50BDNx Description</b>  <b>500V N-Channel Planar MOSFET</b>          HRH5N50BDNx is HRM high voltage MOSFET family based on advanced planar stripe DMOS technology. This advanced MOSFET family has optimized on-state resistance, and also provides superior switching performance and higher avalanche energy strength. This device family is suitable for high efficiency switch mode power supplies.</p>	<div style="display: flex; justify-content: space-around;"> <div style="text-align: center;"> <p>TO-252</p>  </div> <div style="text-align: center;"> <p>TO-220F</p>  </div> </div> <div style="display: flex; justify-content: space-around; margin-top: 20px;"> <div style="text-align: center;"> <p>TO-220</p>  </div> <div style="text-align: center;"> <p>TO-251</p>  </div> </div>	
<p><b>HRH5N50BDNx Features</b></p> <ul style="list-style-type: none"> <li>● RDSON≤2.5Ω @Vgs=10V, Id=2.5A</li> <li>● Ultra Low gate Charge(typical 12.5nC)</li> <li>● Low Crss (typical 3.9pF)</li> <li>● Fast switching capability</li> <li>● 100% avalanche tested</li> <li>● Improved dv/dt capability</li> </ul>	<div style="display: flex; align-items: center; justify-content: center;">  <div style="margin-left: 20px;">  </div> </div>	
<p><b>HRH5N50BDNx Applications</b></p> <ul style="list-style-type: none"> <li>● Switch Mode Power Supply (SMPS)</li> <li>● Uninterruptible Power Supply (UPS)</li> <li>● Power Factor Correction (PFC) (PFC)</li> <li>● Charger</li> </ul>		
<p><b>HRH5N50BDNx Key Performance Parameters</b></p>		
<p><b>Parameter</b></p>	<p><b>Value</b></p>	<p><b>Unit</b></p>
<p><math>V_{DS} @ T_{J,max}</math></p>	<p>550</p>	<p>V</p>
<p><math>R_{DS(on),max}</math></p>	<p>2.5</p>	<p>Ω</p>
<p><math>Q_{g,typ}</math></p>	<p>12.5</p>	<p>nC</p>
<p><math>I_D</math></p>	<p>5</p>	<p>A</p>
<p><math>I_{D,pulse}</math></p>	<p>20</p>	<p>A</p>
<p><b>HRH5N50BDNx Device Marking and Package Information</b></p>		
<p><b>Device</b></p>	<p><b>Package</b></p>	<p><b>Marking</b></p>
<p>HRH5N50BDND</p>	<p>TO-252</p>	<p>H5N50BDND</p>
<p>HRH5N50BDNF</p>	<p>TO-220F</p>	<p>H5N50BDNF</p>
<p>HRH5N50BDNP</p>	<p>TO-220</p>	<p>H5N50BDNP</p>
<p>HRH5N50BDNU</p>	<p>TO-251</p>	<p>H5N50BDNU</p>



## HRH5N50BDNx Absolute Maximum Ratings $T_C = 25^\circ\text{C}$ , unless otherwise noted

Parameter	Symbol	Value	Unit	
Drain-Source Voltage( $V_{GS}=0V$ )	$V_{DS}$	500	V	
Continuous Drain Current <sup>1)</sup>	$I_D$	$T_C = 25^\circ\text{C}$	5	A
		$T_C = 100^\circ\text{C}$	3	
Pulsed Drain Current <sup>2)</sup>	$I_{D,pulse}$	20	A	
Gate-Source Voltage	$V_{GS}$	$\pm 30$	V	
Single Pulse Avalanche Energy <sup>3)</sup>	$E_{AS}$	118	mJ	
MOSFET dv/dt Ruggedness, $V_{DS} = 0 \dots 480V$	dv/dt	5	V/ns	
Power Dissipation For TO-220F	$P_D$	20.4	W	
Power Dissipation For TO-252/220/251		26.4		
Continuous Diode Forward Current	$I_S$	5	A	
Diode Pulsed Current <sup>2)</sup>	$I_{S,pulse}$	20		
Operating Junction and Storage Temperature Range	$T_J, T_{stg}$	-55~+150	$^\circ\text{C}$	

## HRH5N50BDNx Thermal Resistance For TO-220F

Parameter	Symbol	Value	Unit
Thermal Resistance, Junction-to-Case	$R_{thJC}$	6.12	$^\circ\text{C/W}$
Thermal Resistance, Junction-to-Ambient	$R_{thJA}$	80	

## HRH5N50BDNx Thermal Resistance For TO-252/220/251

Parameter	Symbol	Value	Unit
Thermal Resistance, Junction-to-Case	$R_{thJC}$	4.73	$^\circ\text{C/W}$
Thermal Resistance, Junction-to-Ambient	$R_{thJA}$	62	

### Notes

- 1) Limited by maximum junction temperature.
- 2) Repetitive Rating: Pulse width limited by maximum junction temperature.
- 3)  $L=10\text{mH}$ ,  $I_D=3.5\text{A}$ , Start  $T_J=25^\circ\text{C}$



HRH5N50BDNx Electrical Characteristics $T_J = 25^\circ\text{C}$ , unless otherwise noted						
Parameter	Symbol	Test Conditions	Value			Unit
			Min.	Typ.	Max.	
<b>Static Characteristics</b>						
Drain-Source Breakdown Voltage	$V_{(BR)DSS}$	$V_{GS} = 0V, I_D = 250\mu A$	500	--	--	V
Zero Gate Voltage Drain Current	$I_{DSS}$	$V_{DS} = 500V$ $V_{GS} = 0V, T_J = 25^\circ\text{C}$	--	--	1	$\mu A$
		$V_{DS} = 500V,$ $V_{GS} = 0V, T_J = 150^\circ\text{C}$	--	--	100	
Gate-Source Leakage Current	$I_{GSS}$	$V_{GS} = \pm 30V$	--	--	$\pm 100$	nA
Gate-Source Threshold Voltage	$V_{GS(th)}$	$V_{DS} = V_{GS}, I_D = 250\mu A$	2	--	4	V
Drain-Source On-State-Resistance	$R_{DS(on)}$	$V_{GS} = 10V, I_D = 2.5A$	--	2.1	2.5	$\Omega$
Gate Resistance	$R_G$	$f = 1.0\text{MHz}$ open drain	--	2.8	--	$\Omega$
<b>Dynamic Characteristics</b>						
Input Capacitance	$C_{iss}$	$V_{GS} = 0V, V_{DS} = 25V$ $f = 1.0\text{MHz}$	--	274	--	$\mu F$
Output Capacitance	$C_{oss}$		--	36	--	
Reverse Transfer Capacitance	$C_{rss}$		--	3.9	--	
Total Gate Charge	$Q_g$	$V_{DD} = 400V, I_D = 5A$ $V_{GS} = 10V$	--	12.5	--	nC
Gate-Source Charge	$Q_{gs}$		--	3.5	--	
Gate-Drain Charge	$Q_{gd}$		--	4.5	--	
Gate Plateau Voltage	$V_{Plateau}$		--	5.0	--	V
Turn-on Delay Time	$t_{d(on)}$	$V_{DD} = 250V, I_D = 5A$ $R_G = 10\Omega, V_{GS} = 10V$	--	7.8	--	ns
Turn-on Rise Time	$t_r$		--	5.5	--	
Turn-off Delay Time	$t_{d(off)}$		--	33	--	
Turn-off Fall Time	$t_f$		--	16	--	
<b>Drain-Source Body Diode Characteristics</b>						
Body Diode Forward Voltage	$V_{SD}$	$T_J = 25^\circ\text{C}, I_{SD} = 5A$ $V_{GS} = 0V$	--	--	1.2	V
Reverse Recovery Time	$t_{rr}$	$V_R = 400V$ $I_F = 5A, di_F/dt = 100A/\mu s$	--	450	--	ns
Reverse Recovery Charge	$Q_{rr}$		--	1.8	--	$\mu C$



HRH5N50BDNx Typical Characteristics  $T_J = 25^\circ\text{C}$ , unless otherwise noted

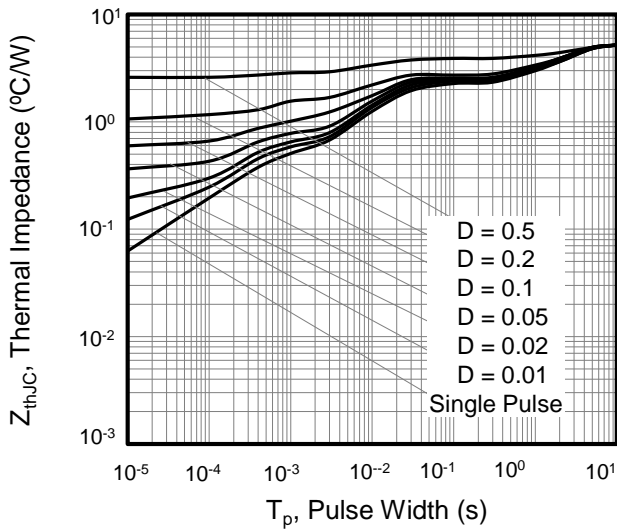


Figure 1. Transient Thermal Impedance For TO-220F

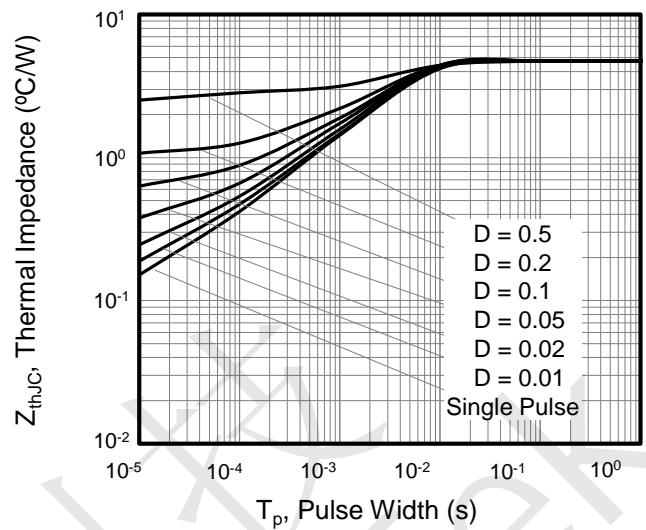


Figure 2. Transient Thermal Impedance For TO-252/220/251

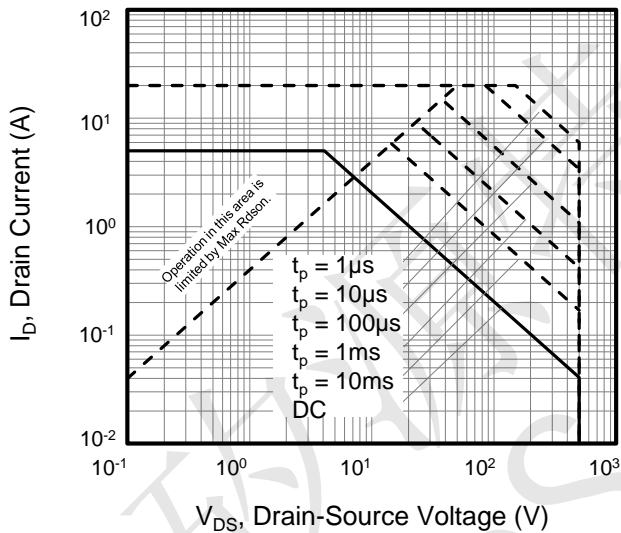


Figure 3. Safe Operation Area For TO-220F

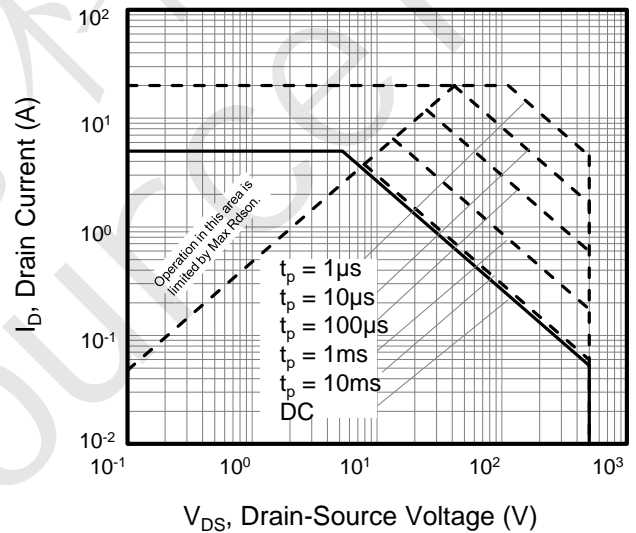


Figure 4. Safe Operation Area For TO-252/220/251

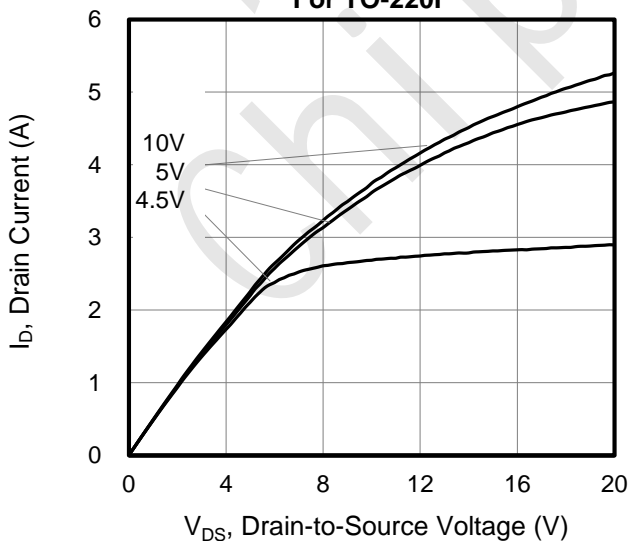


Figure 5. Output Characteristics

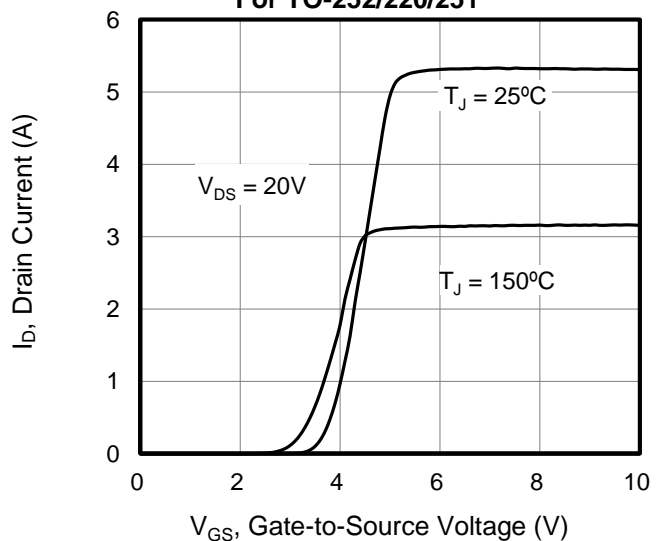
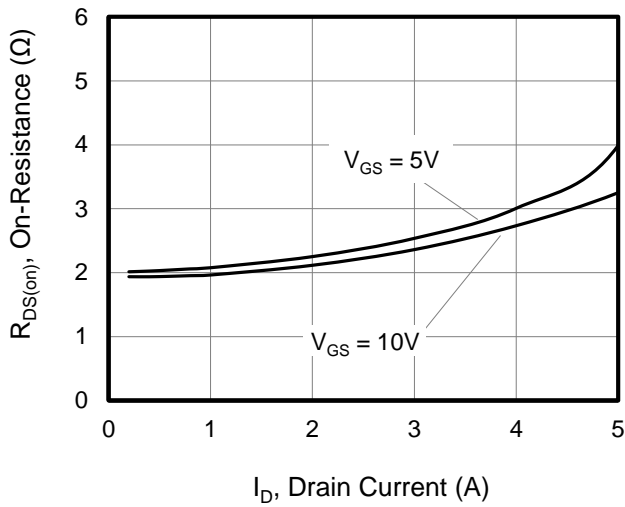


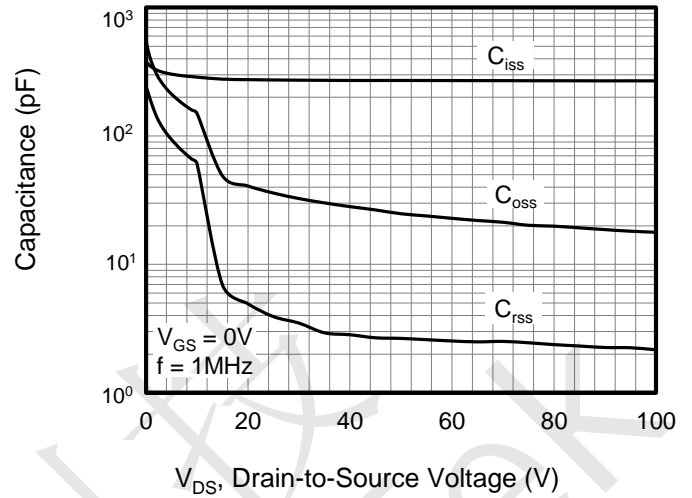
Figure 6. Transfer Characteristics



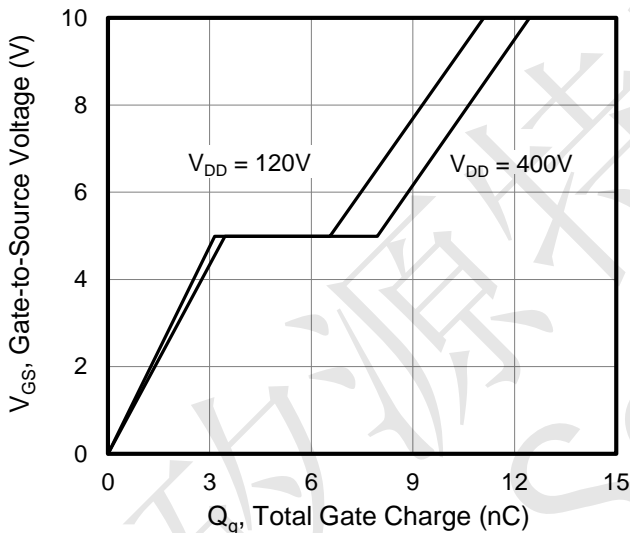
### HRH5N50BDNx Typical Characteristics $T_J = 25^\circ\text{C}$ , unless otherwise noted



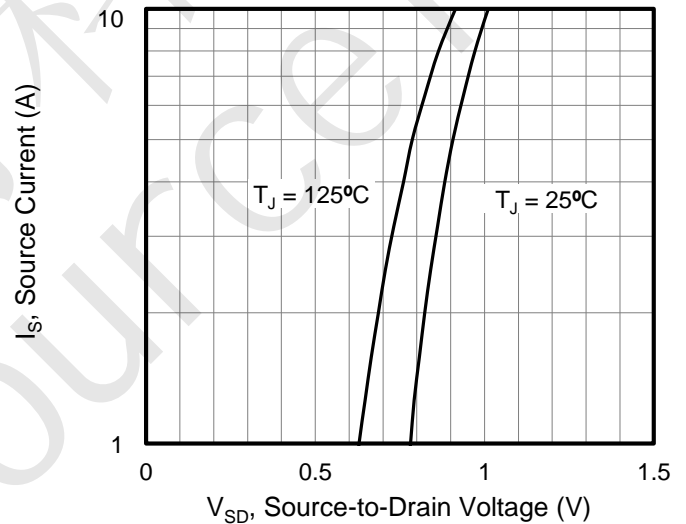
**Figure 7. On-Resistance vs Drain Current**



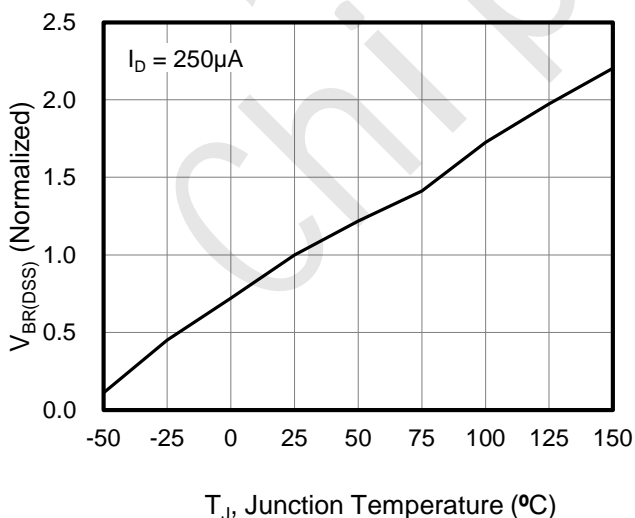
**Figure 8. Capacitance**



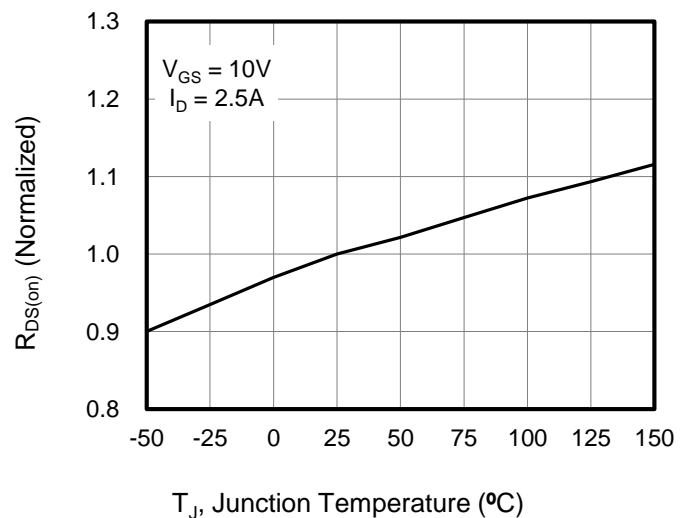
**Figure 9. Gate Charge**



**Figure 10. Body Diode Forward Voltage**



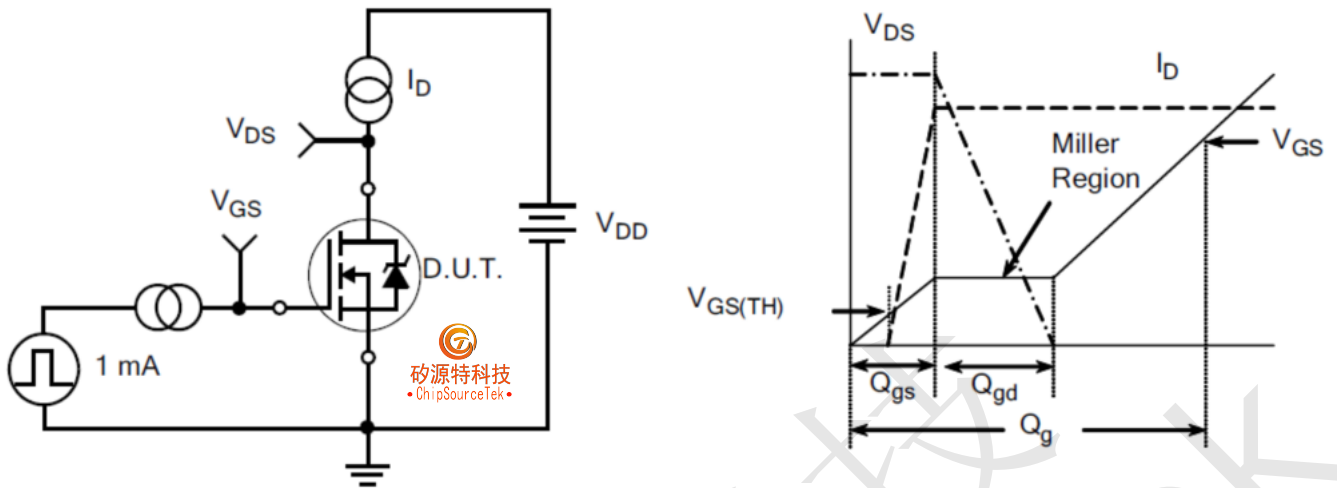
**Figure 11. Breakdown Voltage vs Junction Temperature**



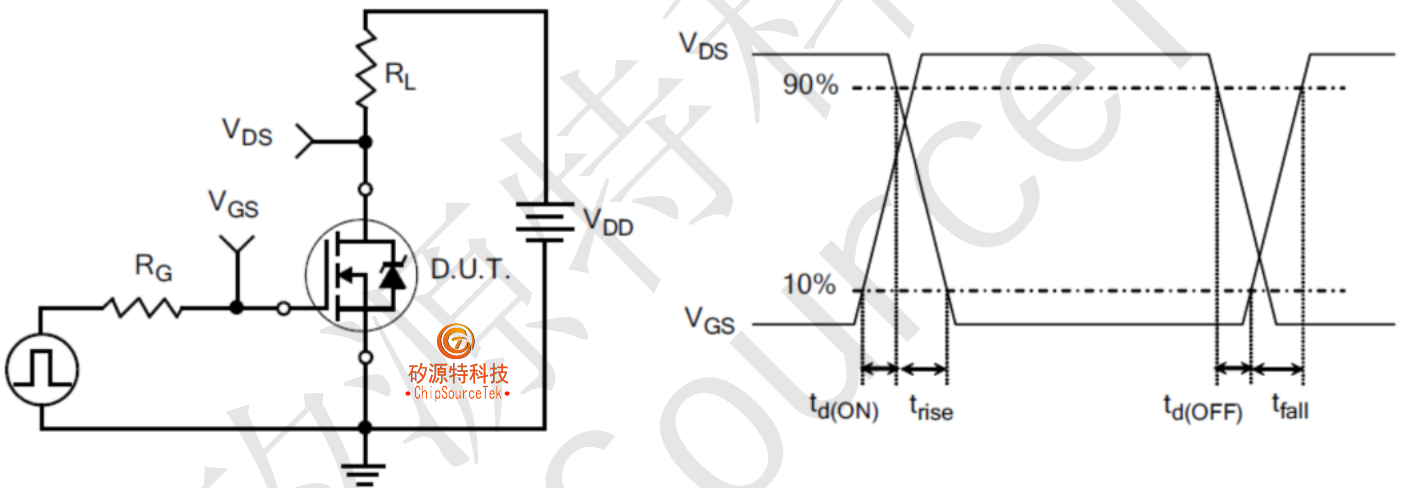
**Figure 12. On-Resistance vs Temperature**



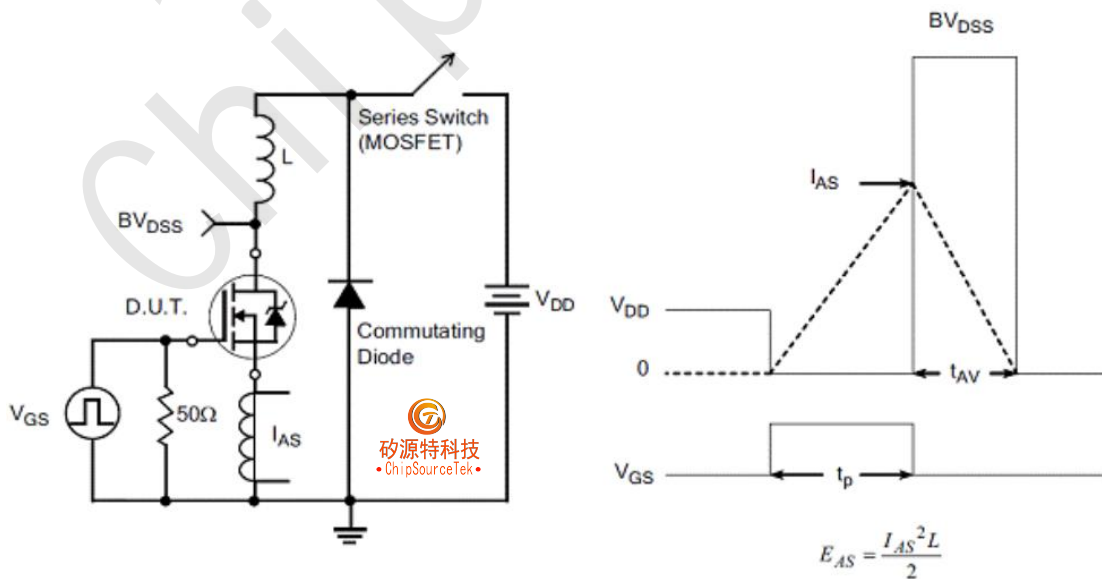
**Figure A: Gate Charge Test Circuit and Waveform**



**Figure B: Resistive Switching Test Circuit and Waveform**

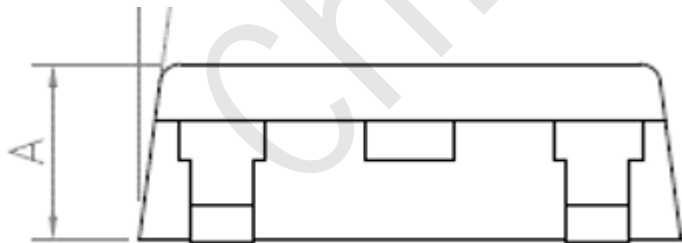
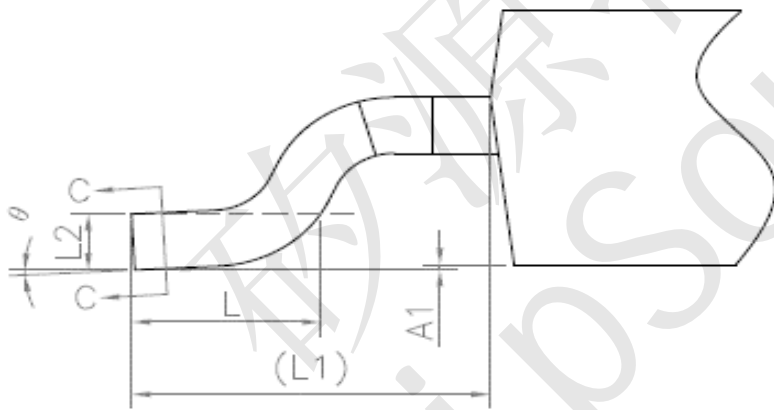
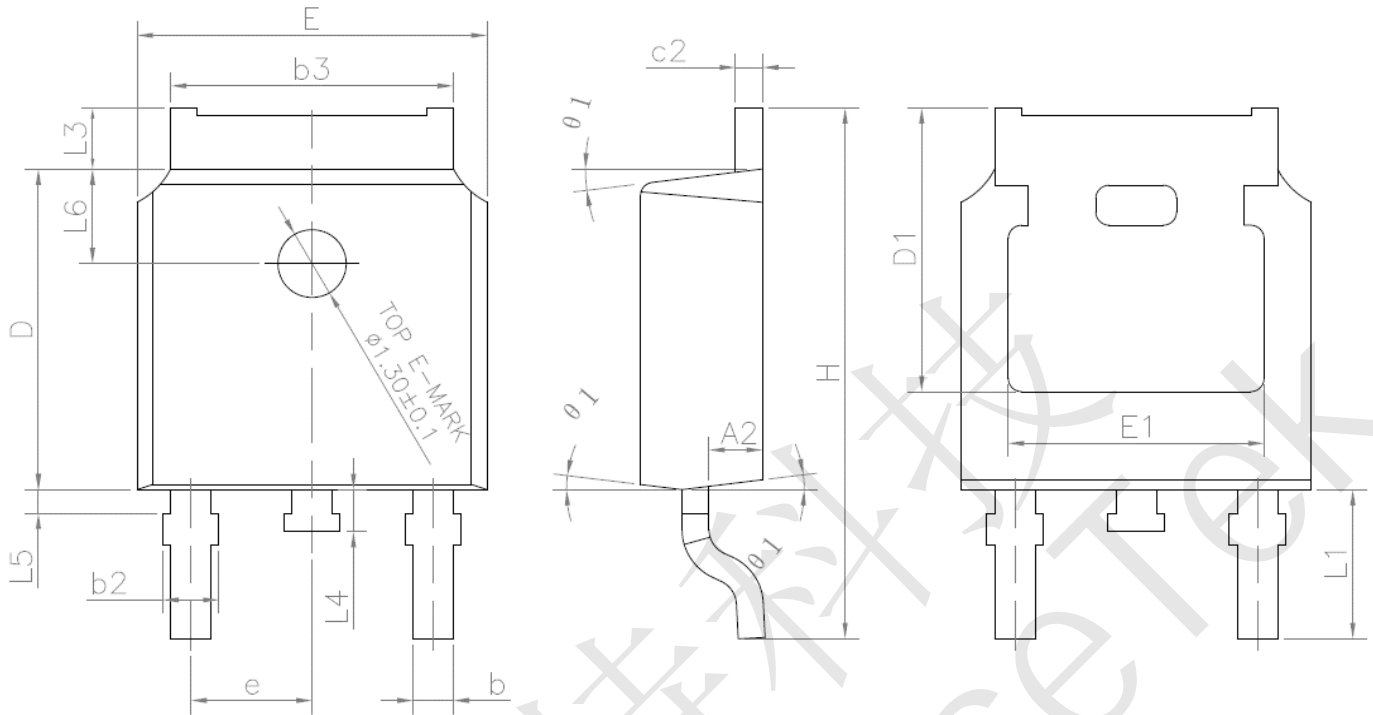


**Figure C: Unclamped Inductive Switching Test Circuit and Waveform**





## HRH5N50BDNx Outlines TO-252 Package

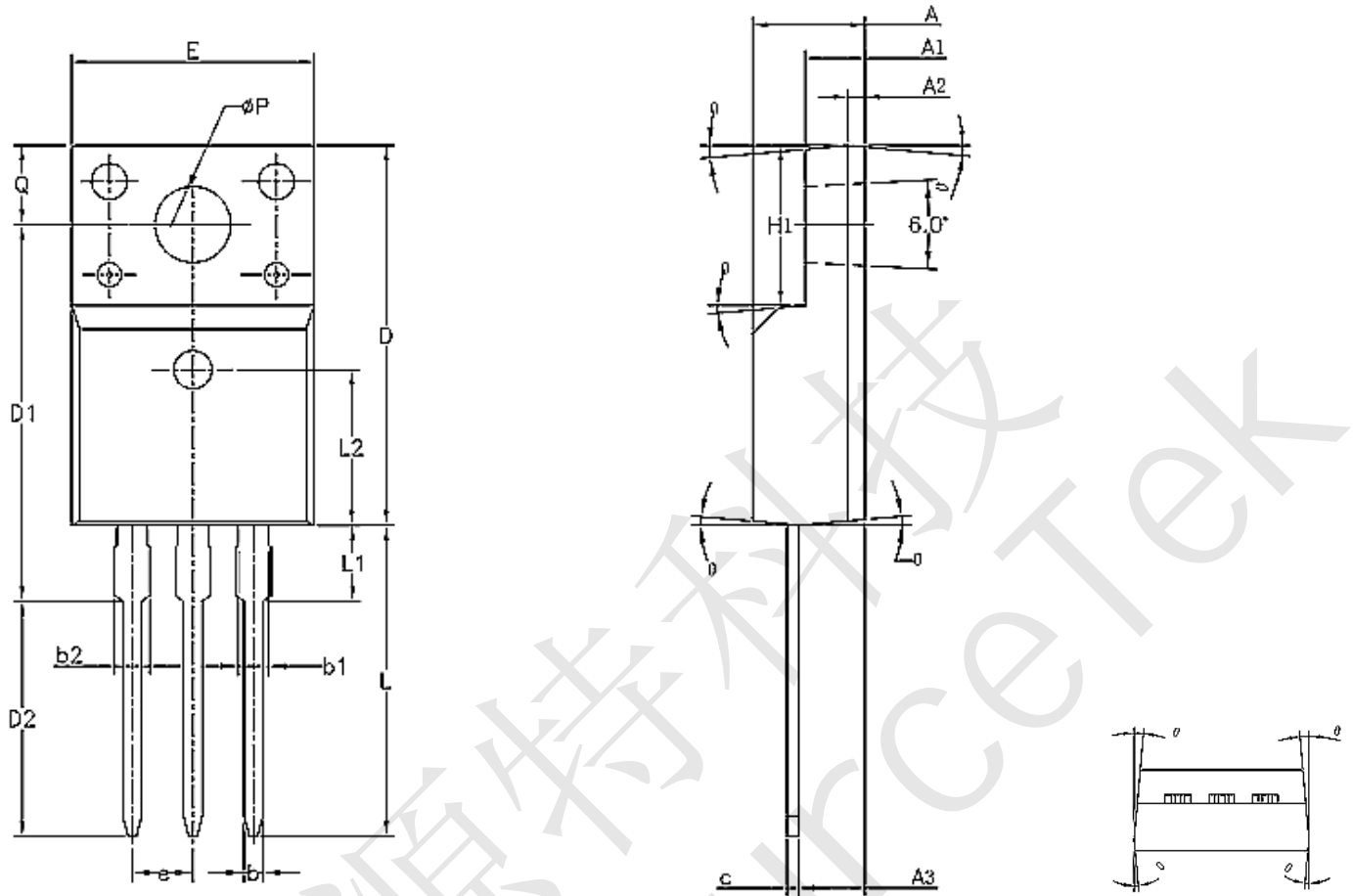


SYMBOL	MIN	NOM	MAX
A	2.2	--	2.4
A1	0	--	0.2
A2	0.9	1.035	1.17
b	0.645	--	0.9
b3	5.13	5.326	5.46
c	0.43	--	0.61
c2	0.41	--	0.61
D	5.98	--	6.73
D1	5.2	--	--
E	5.8	--	6.73
E1	4.63	--	--
e	2.186	2.286	2.386
H	9.4	10.04	10.5
L	1.38	1.5	1.75
L1	2.6	2.872	3.1
L2	0.43	--	0.55
L3	0.88	--	1.28
L4	0.5	--	1
L5	0.15	--	0.75
L6	1.5	1.7	1.95
θ	0°	--	10°
θ1	5°	7°	9°





## HRH5N50BDNx Outlines TO-220F Package

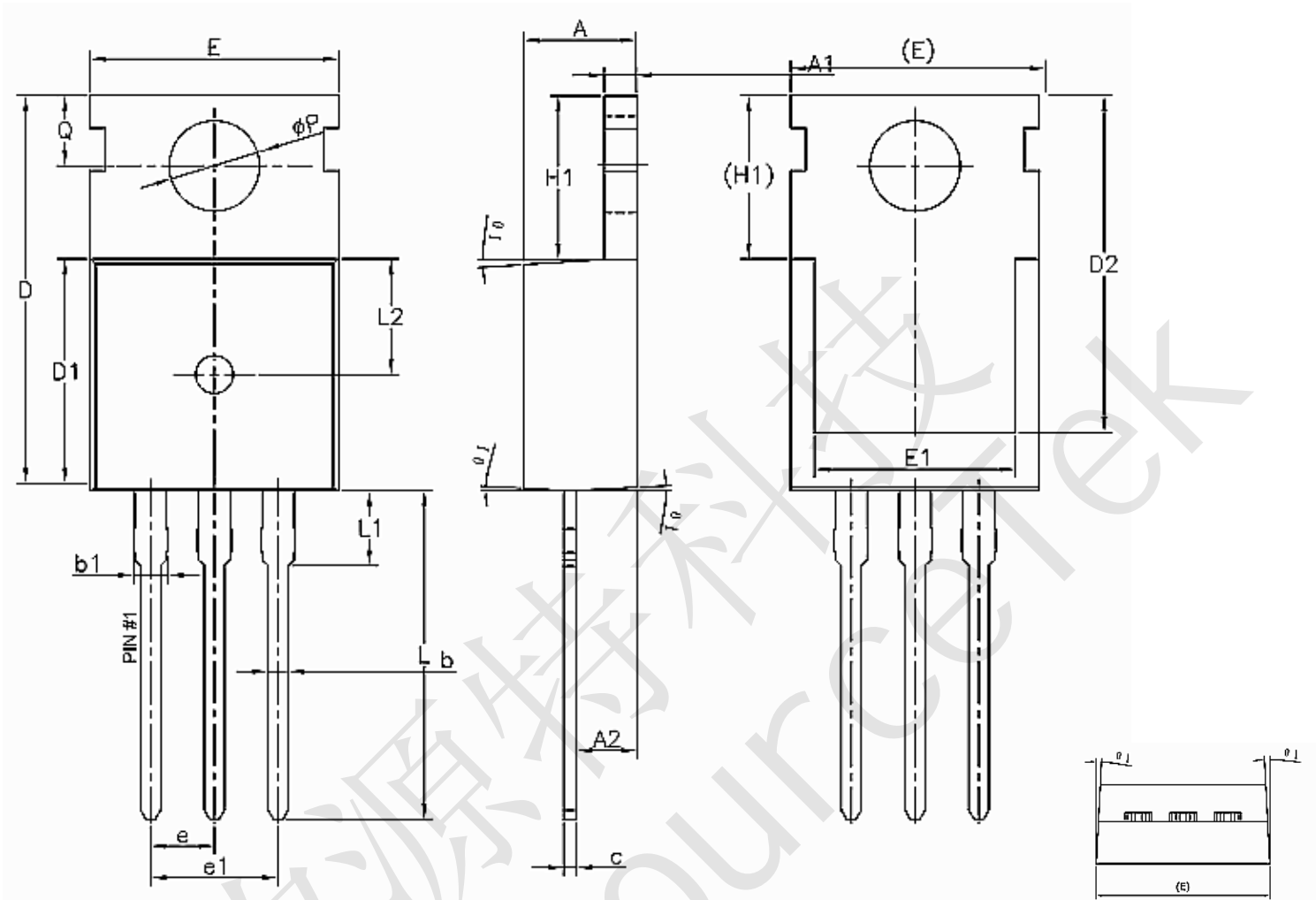


Unit:mm			
Symbol	Min.	Nom	Max.
A	4.50	4.70	4.83
A1	2.34	2.54	2.74
A2	0.70 REF		
A3	2.56	2.76	2.93
b	0.70	---	0.90
b1	1.18	---	1.38
b2	---	---	1.47
c	0.45	0.50	0.60
D	15.67	15.87	16.07
D1	15.55	15.75	15.95

Unit:mm			
Symbol	Min.	Nom	Max.
D2	9.60	9.80	10.0
E	9.96	10.16	10.36
e	2.54 BSC		
H1	6.48	6.68	6.88
L	12.68	12.98	13.28
L1	---	---	3.50
L2	6.50 REF		
ΦP	3.08	3.18	3.28
Q	3.20	---	3.40
θ1	1°	3°	5°



## HRH5N50BDNx Outlines TO-220 Package

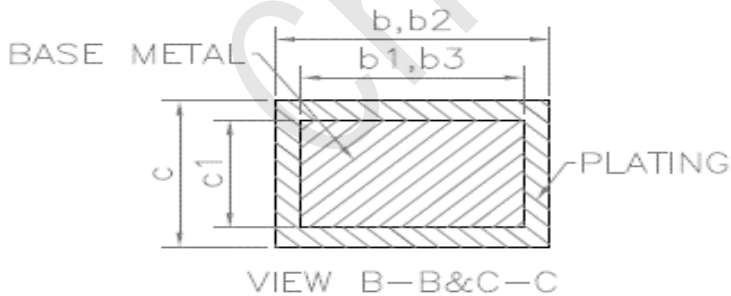
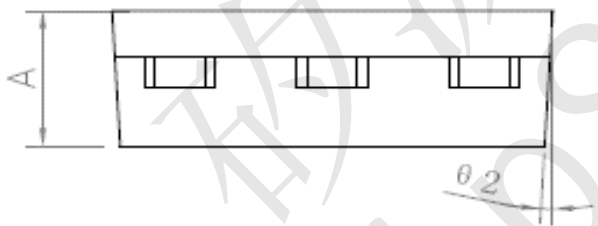
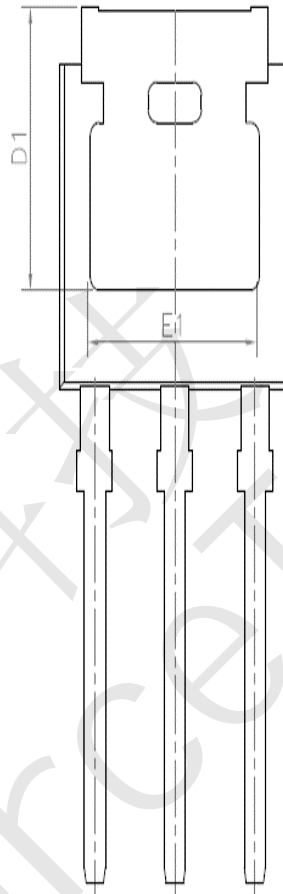
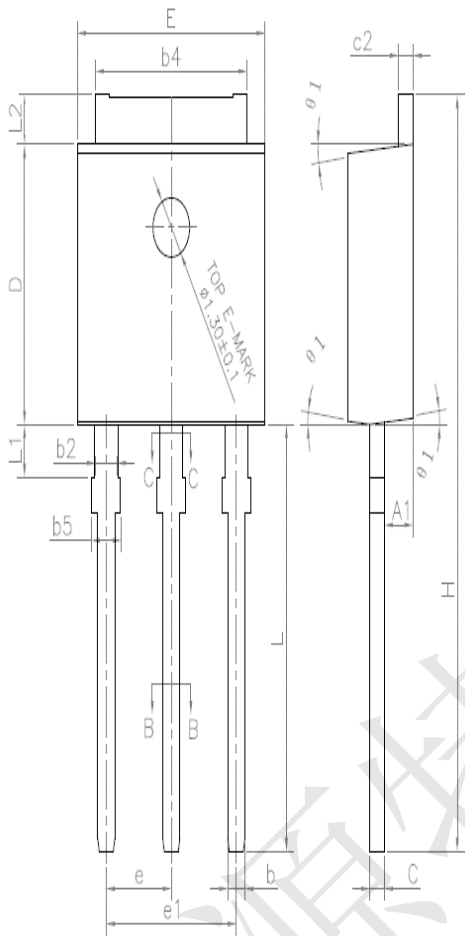


Unit:mm			
Symbol	Min.	Nom	Max.
A	4.40	4.50	4.60
A1	1.27	1.30	1.33
A2	2.30	2.40	2.50
b	0.70	---	0.90
b2	1.27	---	1.40
c	0.45	0.50	0.60
D	15.30	15.70	16.10
D1	9.10	9.20	9.30
D2	13.10	---	13.70
E	9.70	9.90	10.20

Unit:mm			
Symbol	Min.	Nom	Max.
E1	7.80	8.00	8.20
e	2.54 BSC		
e1	5.08 BSC		
H1	6.30	6.50	6.70
L	12.78	13.08	13.38
L1	---	---	3.50
L2	4.60 REF		
ΦP	3.55	3.60	3.65
Q	2.73	---	2.87
θ1	1°	3°	5°



## HRH5N50BDNx Outlines TO-251 Package



SYMBOL	MIN	NOM	MAX
A	2.2	2.3	2.35
A1	0.9	1.01	1.1
b	0.56	--	0.69
b1	0.55	0.6	0.65
b2	0.77	--	0.9
b3	0.76	0.81	0.86
b4	5.23	5.33	5.43
b5	--	--	1.05
c	0.46	--	0.59
c1	0.45	0.51	0.55
c2	0.46	--	0.59
D	6	6.1	6.2
D1	5.2	--	--
E	6.5	6.6	6.7
E1	4.6	4.83	5
e	2.24	2.29	2.34
e1	4.47	4.57	4.67
H	16.18	16.48	16.78
L	9	9.3	9.6
L1	0.95	1.16	1.35
L2	0.9	1.08	1.25
θ	3°	5°	7°
θ1	1°	3°	5°