



HT7182 21V, 14A高效升压转换器/21V, 14A Boost Converter

■ HT7182 FEATURES

- Input voltage range: 2.7V to 21V
 - Output voltage range: up to 21V
 - Internal Fixed PWM frequency: 350kHz
 - Programmable switch peak current limit: up to 14A
 - High Efficiency
 - 95% (PVIN = 12V, VOUT=20V, IOU =2A)
 - 94% (PVIN = 12V, VOUT=20V, IOU =4.5A)
 - 93% (PVIN = 7.2V, VOUT=12V, IOU =1.5A)
 - 90% (PVIN = 7.2V, VOUT=12V, IOU =5A)
 - 96% (PVIN = 12V, VOUT=18V, IOU =1.5A)
 - 95% (PVIN = 12V, VOUT=18V, IOU =6A)
 - 1.0 μ A current consumption during shutdown
 - Two modes with different tr/ tf for EMI solution
 - Programmable soft start
 - Thermal shutdown protection
 - Pb-free Packages,ESOP8
- 输入电压范围: 2.7V-21V
 - 输出电压范围: 最高21V
 - 固定开关频率: 350kHz
 - 可编程峰值电流: 最高14A
 - 高转换效率:
 - 95% (PVIN = 12V, VOUT=20V, IOU =2A)
 - 94% (PVIN = 12V, VOUT=20V, IOU =4.5A)
 - 93% (PVIN = 7.2V, VOUT=12V, IOU =1.5A)
 - 90% (PVIN = 7.2V, VOUT=12V, IOU =5A)
 - 96% (PVIN = 12V, VOUT=18V, IOU =1.5A)
 - 95% (PVIN = 12V, VOUT=18V, IOU =6A)
 - 低关断功耗, 关断电流1uA
 - 支持两种tr/ tf模式, 应对EMI挑战
 - 可编程软启动
 - 热关断等保护
 - ESOP8无铅封装

■ HT7182 APPLICATIONS

- Wireless/ Speakers
 - Portable Speakers
 - Power Bank
 - Chargers
 - Power Interface (USB Type-C, Thunderbolt)
 - POS Terminal
 - Tablet PC/Note Book
- 无线音箱
 - 移动电源
 - USB TYPE-C 电源传输
 - 平板电脑, 笔记本电脑
- 便携式音箱
 - 充电设备
 - 拉杆音箱
 - POS机终端



HT7182 21V, 14A高效升压转换器/21V, 14A Boost Converter

■ HT7182 DESCRIPTION

The HT7182 is a high-power density, asynchronous boost converter with a 20mΩ power switch to provide a high efficiency and small size solution in portable systems. The HT7182 has wide input voltage range from 2.7 V to 25 V to support applications with single cell, two cell Lithium batteries and 12V lead-acid batteries. The device has 14A switch current capability and can provide an output voltage up to 26.8V.

The HT7182 also implements a programmable soft-start function and an adjustable switching peak current limit function. HT7182 integrates two modes with different tr/ tf to balance different requirements of EMI and efficiency.

In addition, the device provides thermal shutdown protection.

HT7182是一款高功率异步升压转换器，集成20mΩ功率开关管，为便携式系统提供高效的小尺寸解决方案。

HT7182具有2.7V至21V宽输入电压范围，可为采用单节或两节锂电池，或12V铅酸电池的应用提供支持。该器件具备14A开关电流能力，并且能够提供高达21V的输出电压。

HT7182还支持可编程的软启动，以及可调节的开关峰值电流限制。HT7182还支持两种不同的tr/ tf，以适应不同的EMI和效率需求。

此外，该器件还提供热关断保护。

■ HT7182 TYPICAL APPLICATION

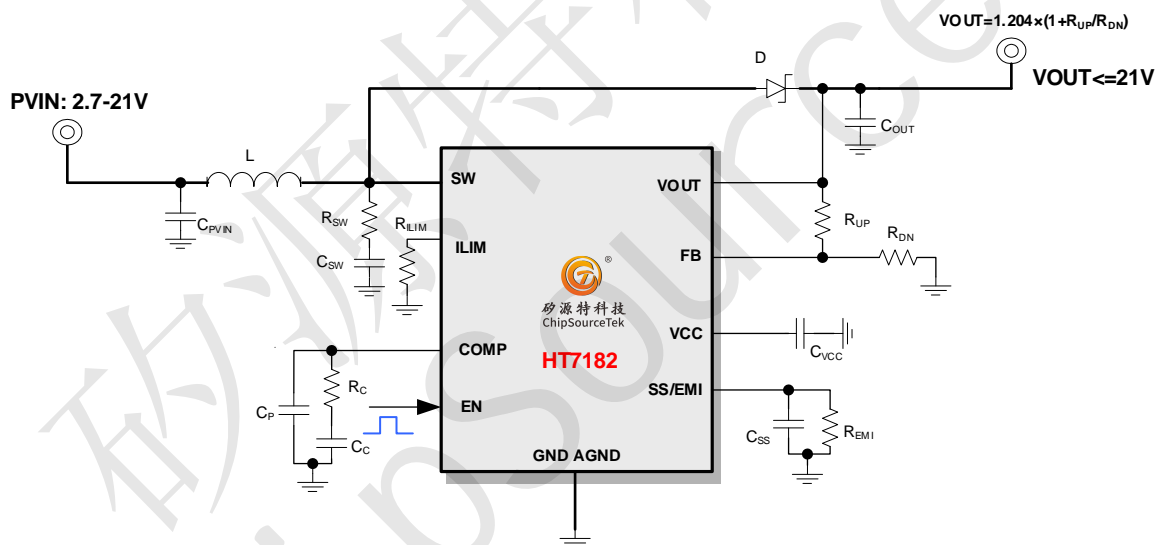



HT7182 21V, 14A 高效升压转换器 / 21V, 14A Boost Converter

■ HT7182 ORDERING INFORMATION

Ordering Number	Package Type	Marking	Operating Temperature Range	Shipping Package / MOQ
HT7182SPER	ESOP8	HT7182 YYYMAAB ¹	-40°C~85°C	Tape and Reel / 2500pcs

Ordering Number

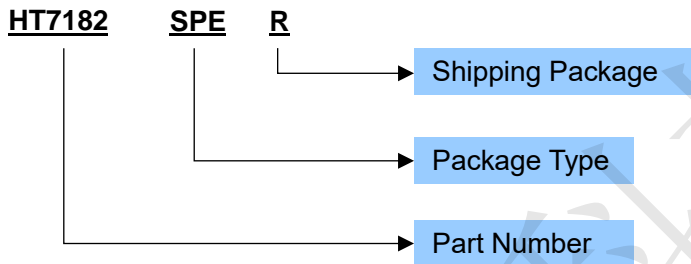

Production Tracking Code

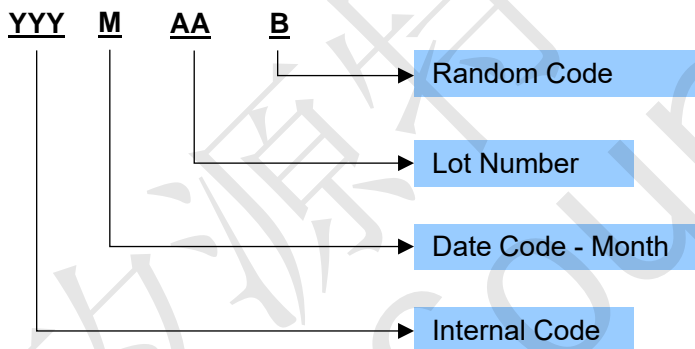



HT7182 21V, 14A高效升压转换器/21V, 14A Boost Converter

HT7182 TERMINAL CONFIGURATION

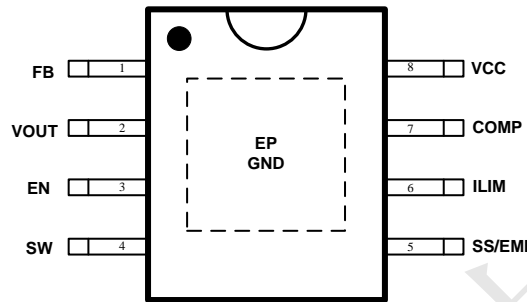

SPE (ESOP8) Top View

HT7182 TERMINAL FUNCTION

Terminal No.	Name	I/O ¹	Description
1	FB	I	Voltage feedback. 电压反馈
2	VOUT	P	Output pin. 输出电压
3	EN	I	Enable logic input. Logic high level enables the device. Logic low level disables the device and turns it into shutdown mode. 使能输入, 高电平芯片工作; 低电平芯片进入关断状态
4	SW	P	The switching node pin of the converter. 开关转换端
5	SS/EMI	O	Soft-start programming pin. An external capacitor C _{ss} connected to ground sets the ramp rate of the internal error amplifier's reference voltage during soft-start, 100nF is usually recommended. 软启动时间设置, 接电容C _{ss} 到地, 一般建议用100nF Also used as mode setting for different tr/ta, an external resistor connected to ground sets a flatter tr/ta. 同时作为tr/ta设置脚, 当同时外接1个330k电阻到地时, 选择较缓的tr/ta
6	ILIM	I	Adjustable switch peak current limit. An external resistor should be connected between this pin and the AGND pin. 峰值电流设置端, 接电阻到地
7	COMP	O	Output of the internal error amplifier, the loop compensation network should be connected between this pin and the AGND pin. 环路补偿端
8	VCC	O	Output of the internal regulator. A ceramic capacitor of 1uF is required between this pin and ground. 内部整流输出, 外接1uF电容到地
EP	GND	G	Provides both electrical and thermal connection from the device to the board. A matching ground pad must be provided on the PCB and the device connected to it via solder. For proper electrical operation, this ground pad must be connected to the system ground. 既是地, 又是散热PAD



HT7182 21V, 14A 高效升压转换器 / 21V, 14A Boost Converter

■ HT7182 SPECIFICATIONS¹

● Absolute Maximum Ratings²

PARAMETER		Symbol	MIN	MAX	UNIT
Voltage range	V _{OUT}	/	-0.3	22	V
	SW		-0.3	24	
	EN, VCC, COMP		-0.3	7	
	FB		-0.3	3.6	
Operating temperature range		T _A	-40	85	°C
Operating junction temperature range		T _J	-40	150	°C
Storage temperature range		T _{STG}	-50	150	°C

● Recommended Operating Conditions

PARAMETER	Symbol	CONDITION	MIN	TYP	MAX	UNIT
	V _{in}	Input Voltage			21	V
	V _{out}	V _{OUT} pin			21	V
Operating temperature	T _a		-40	25	85	°C
Operating junction temperature	T _J		-40		125	°C

● Electrical Characteristics

Condition: T_a = 25°C, V_{IN} = 2.7V-13.2V, V_{OUT}=4.5-13.2V, unless otherwise specified.

Power Supply and Reference Voltage

PARAMETER	Symbol	CONDITION	MIN	TYP	MAX	UNIT
Voltage range	V _{IN}	V _{IN} pin	2.7		21	V
	V _{OUT}	V _{OUT} pin			21	V
Under-voltage lockout (UVLO) threshold	V _{UVLO}	V _{IN} Rising		2.7		V
		V _{IN} Falling		2.5		V
Quiescent current	I _Q	V _{FB} = 1.3V, No switching		0.35		mA
Shutdown current	I _{SD}	IC disabled, no load, no feedback resistor divider		1		uA
VCC regulation	V _{CC}	PV _{IN} = 3.6V, V _{OUT} = 12V, light load		5.8		V
		PV _{IN} = 3.6V, V _{OUT} = 12V, I _{LOAD} = 0.5A		5.3		V
Reference voltage at the FB pin	V _{REF}			1.204		V
Soft-start charging current	I _{SS}			5		uA

EN Input

PARAMETER	Symbol	CONDITION	MIN	TYP	MAX	UNIT
EN high threshold voltage	V _{ENH}		1.5			V
EN low threshold voltage	V _{ENL}				0.4	V
EN internal pull-down resistance	R _{EN}			800		kΩ

¹ Depending on parts and PCB layout, characteristics may be changed.

² Stresses beyond those listed under absolute maximum ratings may cause permanent damage to the device. These are stress ratings only, and functional operation of the device at these or any other conditions beyond those indicated under recommended operating conditions is not implied. Exposure to absolute-maximum-rated conditions for extended periods may affect device reliability.



HT7182 21V, 14A 高效升压转换器 / 21V, 14A Boost Converter

POWER SWITCH

PARAMETER	Symbol	CONDITION	MIN	TYP	MAX	UNIT
MOSFET on-resistance	$R_{DS(on)}$	Including wire bond		20		m Ω
Operation Frequency	F_{osc}			350		kHz

CURRENT LIMIT

PARAMETER	Symbol	CONDITION	MIN	TYP	MAX	UNIT
Peak switch current limit	I_{LIM}				14	A

THERMAL SHUTDOWN

PARAMETER	Symbol	CONDITION	MIN	TYP	MAX	UNIT
Thermal shutdown threshold	T_{SD}			150		$^{\circ}C$
Thermal shutdown hysteresis	T_{SD_HYS}			20		$^{\circ}C$



HT7182 21V, 14A 高效升压转换器 / 21V, 14A Boost Converter

HT7182 TYPICAL OPERATING CHARACTERISTICS

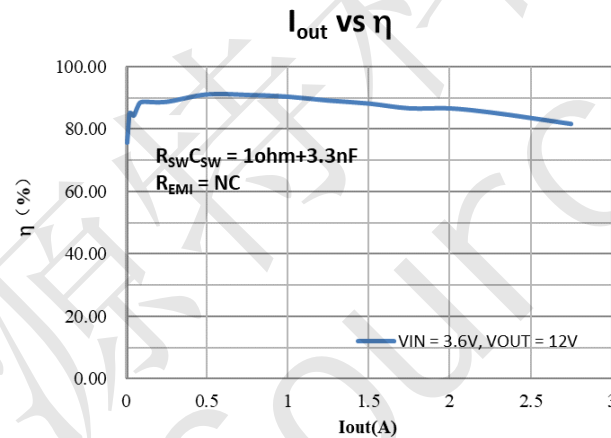
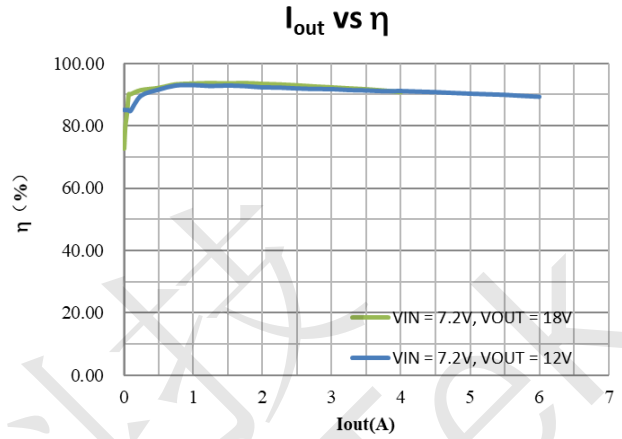
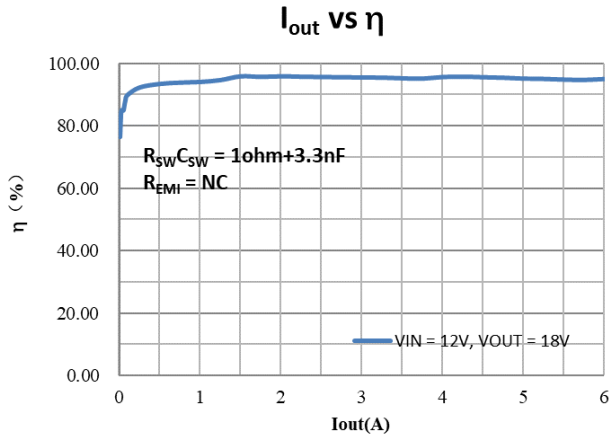



HT7182 21V, 14A 高效升压转换器 / 21V, 14A Boost Converter

■ HT7182 APPLICATION INFORMATION

1 Operation

The HT7182 is a high-power density, asynchronous boost converter with a 20mΩ power switch to provide a high efficiency and small size solution in portable systems. The switching frequency is 360kHz. HT7182 operates with pulse width modulation (PWM), and improves the efficiency at light load with the pulse frequency modulation (PFM).

HT7182 是一款高功率异步升压转换器，集成 20mΩ 功率开关管，为便携式系统提供高效的小尺寸解决方案。其开关频率是 350kHz。HT7182 工作在 PWM 模式，但在轻载时工作在 PFM 模式以提高工作效率。

2 Enable, Startup, and tr/TF (EN and SS/EMI pin)

The HT7182 has an adjustable soft start function to prevent high inrush current during start-up. To minimize the inrush current during start-up, an external capacitor, connected to the SS/EMI pin and charged with a constant current, is used to slowly ramp up the internal positive input of the error amplifier. The larger the capacitance at the SS/EMI pin, the slower the ramp of the output voltage and the longer the soft-start time. A 100-nF capacitor is usually sufficient for most applications.

HT7182 具有可调节软启动功能，以防止芯片启动瞬间的大电流，其通过 SS/EMI 端外接电容 (C_{SS}) 实现，C_{SS} 越大，软启动时间越长，输出电压启动越缓。100nF 的电容可满足大多数应用。

HT7182 integrates two modes with different tr/TF. With a single capacitor (C_{SS}) connected between SS/EMI pin and Ground, the mode with steep tr/TF will be selected, HT7182 operates with a higher efficiency and poorer EMI performance. However, if a capacitor (C_{SS}) paralleled with a resistor 330k (R_{EMI}) is placed between SS/EMI pin and Ground, the mode with flatter tr/TF is selected, HT7182 operates with a lower efficiency and better EMI performance.

HT7182 具有两种不同 tr/TF 时间的模式。当 SS/EMI 引脚仅接一个电容 (C_{SS}) 到地时，tr/TF 更陡，此时 HT7182 的效率更高，但 EMI 表现更差；当 SS/EMI 引脚接一个电容 (C_{SS}) 并联 330k 电阻到地时，tr/TF 更缓，此时 HT7182 的效率更低，但 EMI 表现更好。

When the EN pin is pulled into logic low (below 0.4V), the HT7182 goes into the shutdown mode and stops switching. Only when EN pin is pulled into logic high (above 1.5V), the HT7182 works.

芯片的 EN 脚可控制芯片的开启与关断。EN 脚拉低，芯片进入关断模式，停止升压；EN 脚拉高，芯片进入升压工作模式。

3 Adjustable Peak Current Limit (ILIM pin)

To avoid an accidental large peak current, an internal cycle-by-cycle current limit is adopted. The low-side switch is turned off immediately as soon as the switch current touches the limit. The peak switch current limit can be set by a resistor (R_{ILIM}) at the ILIM pin to ground. The relationship between the current limit and the resistance is as the following figure. The current limit should be set lower than 14A.

为避免可能的突发性大电流尖峰，HT7182 内置了逐周期过流限制保护功能。一旦开关电流达到设定的峰值电流限流值，低端管立即关闭，以防止芯片大电流损坏。

峰值电流限流值可通过 ILIM 引脚接电阻 (R_{ILIM}) 至地设置，关系如下图。峰值电流限制值设置应小于 14A。

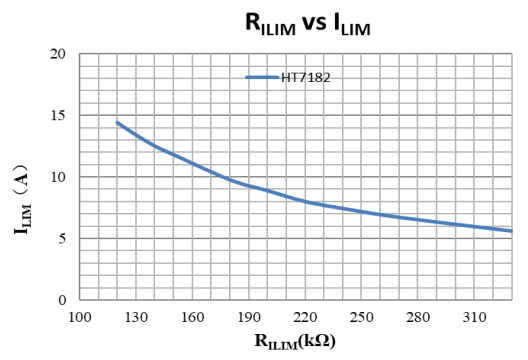

Figure 1 Peak Current Limit (ILIM) vs ILIM terminal resistor (R_{ILIM})



HT7182 21V, 14A 高效升压转换器 / 21V, 14A Boost Converter

4 Output Voltage Setting (FB pin)

The output voltage is set by an external resistor divider (R_{UP} , R_{DN} in the Typical Application Circuit). To get the output voltage V_{OUT} , the Value of R_{UP} and R_{DN} can be calculated as:

输出电压值 V_{OUT} 可通过 FB 端的 R_{UP} , R_{DN} 电阻决定:

$$V_{OUT} = V_{REF} \times \left(1 + \frac{R_{UP}}{R_{DN}}\right)$$

Where $V_{REF} = 1.204V$.

其中 $V_{REF} = 1.204V$ 。

Some typical output voltages can be set as the following parameters

典型电压设置参数如下表。

Table 1 Output Voltage Settings

$V_{OUT}(V)$	$R_{UP}(\Omega)$	$R_{DN}(\Omega)$
9.4	510k	75k
12.2	510k	56k
15.5	510k	43k
21	510k	31k

5 Protection Function

5.1 Under-voltage Lockout (UVLO)

The UVLO circuit prevents the device from malfunctioning at low input voltage and the battery from excessive discharge. The HT7182 has both V_{OUT} UVLO function and V_{CC} UVLO function. It disables the device from switching when the falling voltage at the V_{OUT} pin trips the UVLO threshold V_{UVLO} , which is typically 2.5V. The device starts operating when the rising voltage at the V_{OUT} pin is above the V_{UVLO} , which is typically 2.7V. It also disables the device when the falling voltage at the V_{CC} pin trips the UVLO threshold, which is typically 2.1V.

欠压锁定电路可防止低电压下电路的故障, 以及输入端电阻的过放电。HT7182 的 V_{OUT} 端和 V_{CC} 端均有该功能。当电压低于相应阈值, 芯片关闭。电压高于相应阈值, 芯片开启。

5.2 Thermal Shutdown

A thermal shutdown is implemented to prevent damages due to excessive heat and power dissipation. Typically, the thermal shutdown happens at a junction temperature of 150°C. When the thermal shutdown is triggered, the device stops switching until the junction temperature falls below typically 130°C, then the device starts switching again.

当芯片内部结温高于 150°C 时, 过温关断保护启动, 芯片停止工作, 直至芯片内部结温降低至 130°C。该功能可有效防止芯片损坏。



HT7182 21V, 14A高效升压转换器/21V, 14A Boost Converter

6 Application Note

6.1 Inductor Selection

Because the selection of the inductor affects the power supply's steady state operation, transient behavior, loop stability, and boost converter efficiency, the inductor is the most important component in switching power regulator design. Three most important specifications to the performance of the inductor are the inductor value, DC resistance, and saturation current.

To be simplified, the inductor value can be set as 4.7uH which can be used in most cases.

The rated current, especially the saturation current should be larger than the peak current during the whole operation. The peak current can be calculated as follows.

$$I_{Lpeak} = I_{DC} + \frac{I_{PP}}{2}$$

$$I_{DC} = \frac{V_{OUT} \times I_{OUT}}{V_{IN} \times \eta}$$

$$I_{PP} = \frac{1}{L \times \left(\frac{1}{V_{OUT} - V_{IN}} + \frac{1}{V_{IN}} \right) \times f_{SW}}$$

Boost converter efficiency is affected significantly by the inductor's DC resistance (DCR), equivalent series resistance (ESR) at the switching frequency, and the core loss. An inductor with lower DCR and ESR would increase the efficiency significantly.

The inductor should be placed as close as possible to the SW pin. For a lower EMI radiation, connecting a resistor and a capacitor in series to the ground would be helpful. 1ohm resistor and 3.3nF capacitor (the package of resistor and capacitor is recommended to be not smaller than 1206) would be recommended in most cases.

6.2 Output Capacitor Selection (C_{OUT})

To be simplified, we recommend low-ESR capacitors of 1uF//10uF//10uF//470uF ("//" represents paralleled) be placed as close as possible to the Schottky diode for small output voltage ripple.

Capacitors can lose most of their capacitance at rated voltage. Therefore, leave margin on the voltage rating to ensure adequate effective capacitance.

In detail, for the require output voltage ripple, use the following equations to calculate the minimum required effective capacitance C_{OUT}.

$$V_{ripple_dis} = \frac{(V_{OUT} - V_{INMIN}) \times I_{OUT}}{V_{OUT} \times f_{SW} \times C_{OUT}}$$

$$V_{ripple_ESR} = I_{Lpeak} \times R_{C_ESR}$$

电感的选择直接影响到电源的稳定,瞬态表现,环路稳定,升压转换效率,因此,电感是升压电路中最重要器件。其中,电感值、饱和电流、直流阻抗 DCR 为重要的选型指标。

对于电感值,简单来说,4.7uH 能满足大多数应用。

对于饱和电流,其应大于芯片所有工作条件下的最大电流峰值。最大电流峰值可通过如下计算。

升压转换效率受电感的DCR和高频时的ESR影响较大,所以选择较低的DCR和ESR能有效提升效率。

另外,电感在PCB Layout时,应紧靠SW脚。

最后,在SW端加入RC串联电路到地,能有效减小电路产生的EMI辐射。一般的,R=1ohm,C=3.3nF,,(建议均使用不小于1206的封装),可满足应用。

为了达到良好的滤波和减小电源纹波,一般的,低 ESR 的 1uF//10uF//10uF//470uF 电容尽量靠近二极管引脚放置,可满足大部分应用。

需要注意的是,电容在额定电压下,容值损失严重,因此,电容的额定电压应留有余量的大于最大输出电压。

详细的,最低要求的电容值应满足以下条件:



HT7182 21V, 14A 高效升压转换器 / 21V, 14A Boost Converter

Where

- V_{ripple_dis} is output voltage ripple caused by charging and discharging of the output capacitor.
- V_{ripple_ESR} is output voltage ripple caused by ESR of the output capacitor.
- V_{IN_MIN} is the minimum input voltage of boost converter.
- V_{OUT} is the output voltage.
- I_{OUT} is the output current.
- I_{Lpeak} is the peak current of the inductor.
- f_{SW} is the converter switching frequency.
- R_{C_ESR} is the ESR of the output capacitors.

6.3 Diode Selection

Schottky diode with fast recovery times and low forward voltages are recommended. Ensure the diode average and peak current rating exceed the average output current and peak inductor current. In addition, the diode's reverse breakdown voltage must exceed the output voltage.

6.4 Loop Stability

The HT7182 requires external compensation, which allows the loop response to be optimized for each application. The COMP pin is the output of the internal error amplifier. An external compensation network comprised of resistor R_C, ceramic capacitors C_C and C_P is connected to the COMP pin.

To be simplified, R_C is 33kΩ, C_C is 3.3nF, and C_P is 47pF. But notice that this setting can only be adopted in most cases. In detail, the compensation network parameters can be calculated as follows.

(1) Set the cross over frequency, f_c

The first step is to set the loop crossover frequency, f_c. The higher crossover frequency, the faster the loop response is. It is generally accepted that the loop gain cross over no higher than the lower of either 1/10 of the switching frequency, f_{SW}, or 1/5 of the RHPZ frequency, f_{RHPZ}. It's proper to use a fixed parameter of 10kHz for f_c.

(2) Set the compensation resistor, R_C.

$$f_{RHPZ} = \frac{R_O \times (1 - D)^2}{2\pi \times L} \quad (2) \text{设置 } R_C$$

(3) Set the compensation zero capacitor, C_C.

$$R_C = \frac{2\pi \times V_{OUT} \times R_{sense} \times f_c \times C_O}{(1 - D) \times V_{REF} \times G_{EA}} \quad (3) \text{设置 } C_C$$

$$C_C = \frac{R_O \times C_O}{2 \times R_C}$$

其中:

- V_{ripple_dis} 是由输出电容充放电引起的输出电压纹波。
- V_{ripple_ESR} 是由输出电容 ESR 引起的输出电压纹波。
- V_{IN_MIN} 是最小输入电压。
- V_{OUT} 是输出电压。
- I_{OUT} 是输出电流。
- I_{Lpeak} 是电感的峰值电流。
- f_{SW} 是开关频率。
- R_{C_ESR} 是输出电容的 ESR。

肖特基二极管应选择快恢复时间和低正向电压。应确保二极管的平均额定电流、峰值额定电流超过输出平均电流和电感峰值电流。此外，二极管的反向击穿电压应大于输出电压。

COMP 是内部误差信号放大器的输出，其外接一个补偿电路（典型电路中的 R_C, C_C, C_P）可针对不同应用改善环路响应。

一般的, R_C = 56kΩ, C_C = 3.3nF, C_P = 47pF, 可满足大部分应用。COMP 端环路补偿设置很重要, 若不合理, 会造成升压在重载下提早不稳, 且严重影响效率。需根据具体应用调试, 合理配置具体的, 参数可通过如下步骤计算:

(1) 设置交叉频率 f_c

f_c 频率越高, 环路响应越快, 但其不能大于 1/10 的 f_{SW} 和 1/5 的 f_{RHPZ}, 一般可直接取值 10kHz。其中:



HT7182 21V, 14A 高效升压转换器 / 21V, 14A Boost Converter

(4) Set the compensation pole capacitor, C_P .

(4) 设置 C_P

$$C_P = \frac{R_{ESR} \times C_O}{R_C}$$

If the C_P is less than 10pF, it can be left open.

如果 C_P 小于 10pF, 其可悬空。

- R_O is the output load resistance.
- D is the switching duty cycle. $1 - D = V_{IN} / V_{OUT}$
- R_{sense} is the equivalent internal current sense resistor, which is 0.084 Ω .
- C_O is output capacitor.
- V_{REF} is the reference voltage at the FB pin, which is 1.204V.
- G_{EA} is the amplifier's transconductance, which is 190 μ A/V.
- R_{ESR} is the equivalent series resistance of the output capacitor.

- R_O 是输出负载。
- D 为占空比, $1 - D = V_{IN} / V_{OUT}$ 。
- R_{sense} 是内部等效电流感应电阻, 为 0.084 Ω 。
- C_O 是输出电容。
- V_{REF} 是 FB 脚的电压, 为 1.204V。
- G_{EA} 是误差放大器跨阻吗, 为 190 μ A/V。
- R_{ESR} 是输出滤波电容的等效串联。

6.5 Layout Considerations

As for all switching power supplies, especially those running at high switching frequency and high currents, layout is an important design step. If layout is not carefully done, the regulator could suffer from instability and noise problems.

对于 DCDC 电源, 特别是运行在大电流、高频率状态下, **Layout** 是非常关键的因素, 不佳的 **Layout** 可能影响其工作的稳定。

- Use integral GND ground plane under the chip
- Minimize the length and area of all traces connected to the SW pin
- The power traces, consisting of the GND trace, the SW trace, the PVIN trace and the VOUT trace should be kept short, direct and wide.
- The input capacitor needs to be close to inductor L and GND pin in order to reduce the input supply ripple. The output capacitor needs to be close to Diode and GND pin in order to reduce the output supply ripple.
- The resistor divider R_{UP} and R_{DN} must be connected to FB pin directly as closely as possible.
- The layout should also be done with well consideration of the thermal as this is a high-power density device. A thermal pad that improves the thermal capabilities of the package should be soldered to the large ground plate, using thermal vias underneath the thermal pad.

- 芯片下面应尽量使用完整铺地。
- SW 走线尽量短, 低阻抗。
- 电源走线, 包括 GND、SW、PVIN、VOUT, 应尽可能短而粗。
- 输入电容应尽可能靠近相应引脚和器件(电感 L), 并以低阻抗良好接地。若有条件, 尽量选择 ESR 小的滤波电容, 或者容值足够大, 以提高开关管打开瞬间, 给电感充电的能量。尤其是单节锂电池供电情况, 若输入端纹波较大, 可能造成芯片欠压保护。电源至电感、SW 的走线应尽可能短而低阻抗。

输出电容应尽可能靠近二极管, 并以低阻抗良好接地。电源输出走线应尽可能短而低阻抗。滤波小电容尽量靠近二极管摆放, 以降低 OUT 上的电压毛刺, 以及降低 EMC 辐射。

- R_{UP} 和 R_{DN} 尽量靠近 FB 引脚。
- 芯片背部的散热片应良好接至 PCB 表面露铜的地, 并通过过孔将热量传递至背面大面积地平面, 以增加散热面积。



HT7182 21V, 14A 高效升压转换器 / 21V, 14A Boost Converter

6.6 Typical Circuit Diagram (ESOP8)

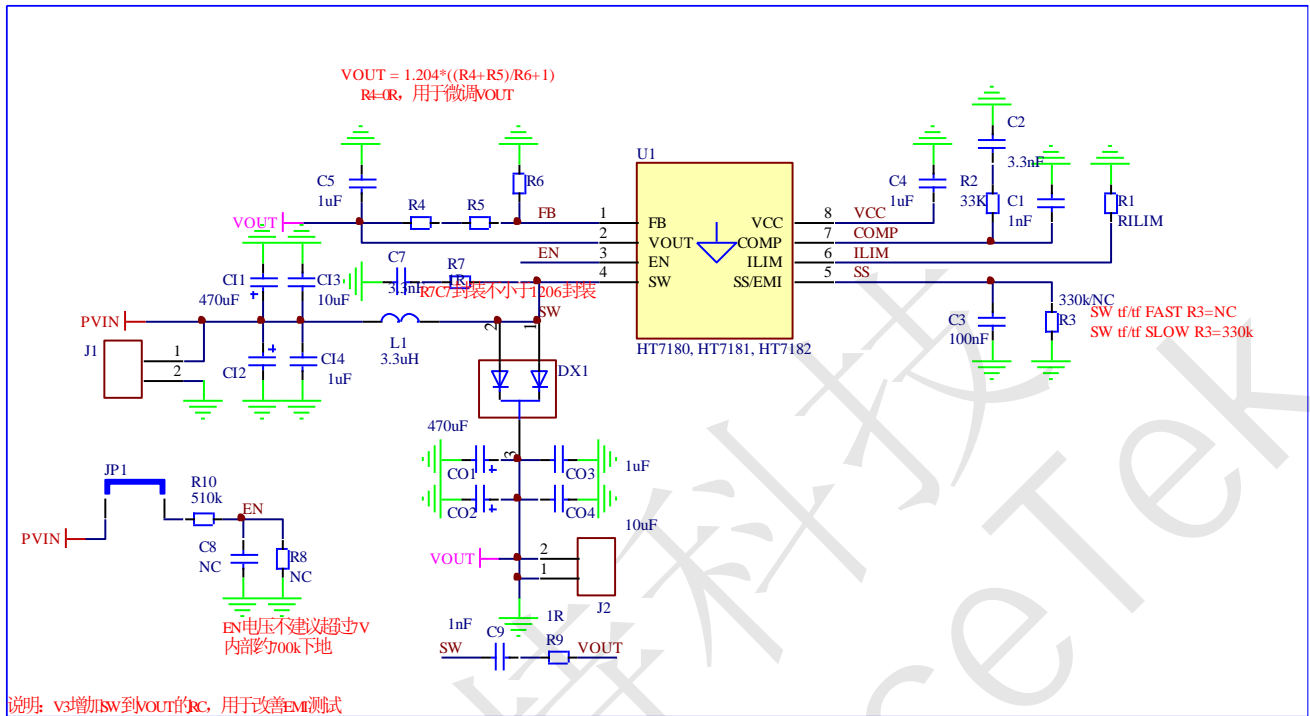



HT7182 21V, 14A高效升压转换器/21V, 14A Boost Converter

7 PCB Layout

7.1 Top Layer (ESOP8)

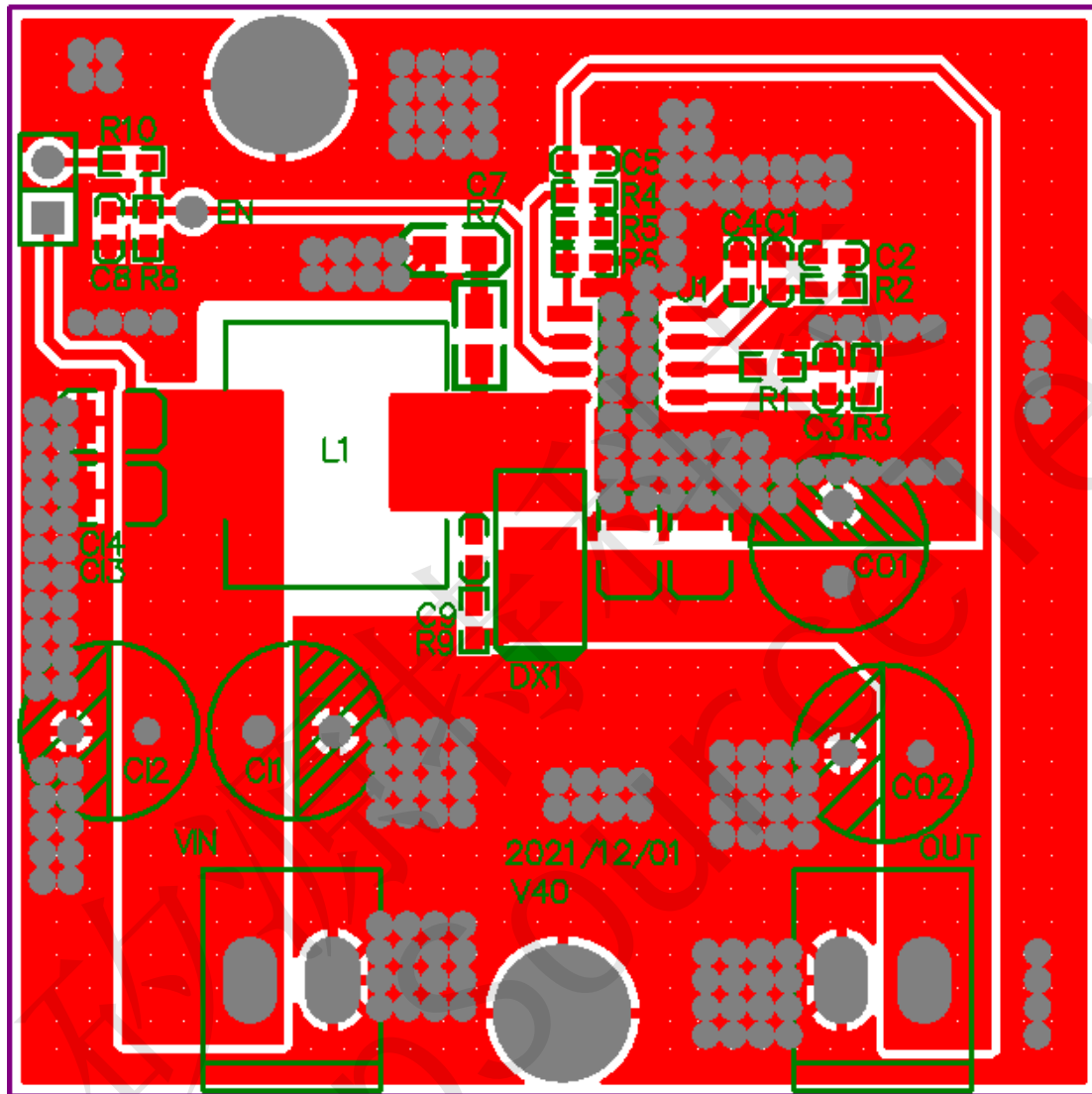



HT7182 21V, 14A高效升压转换器/21V, 14A Boost Converter

7.2 Bottom Layer (ESOP8)

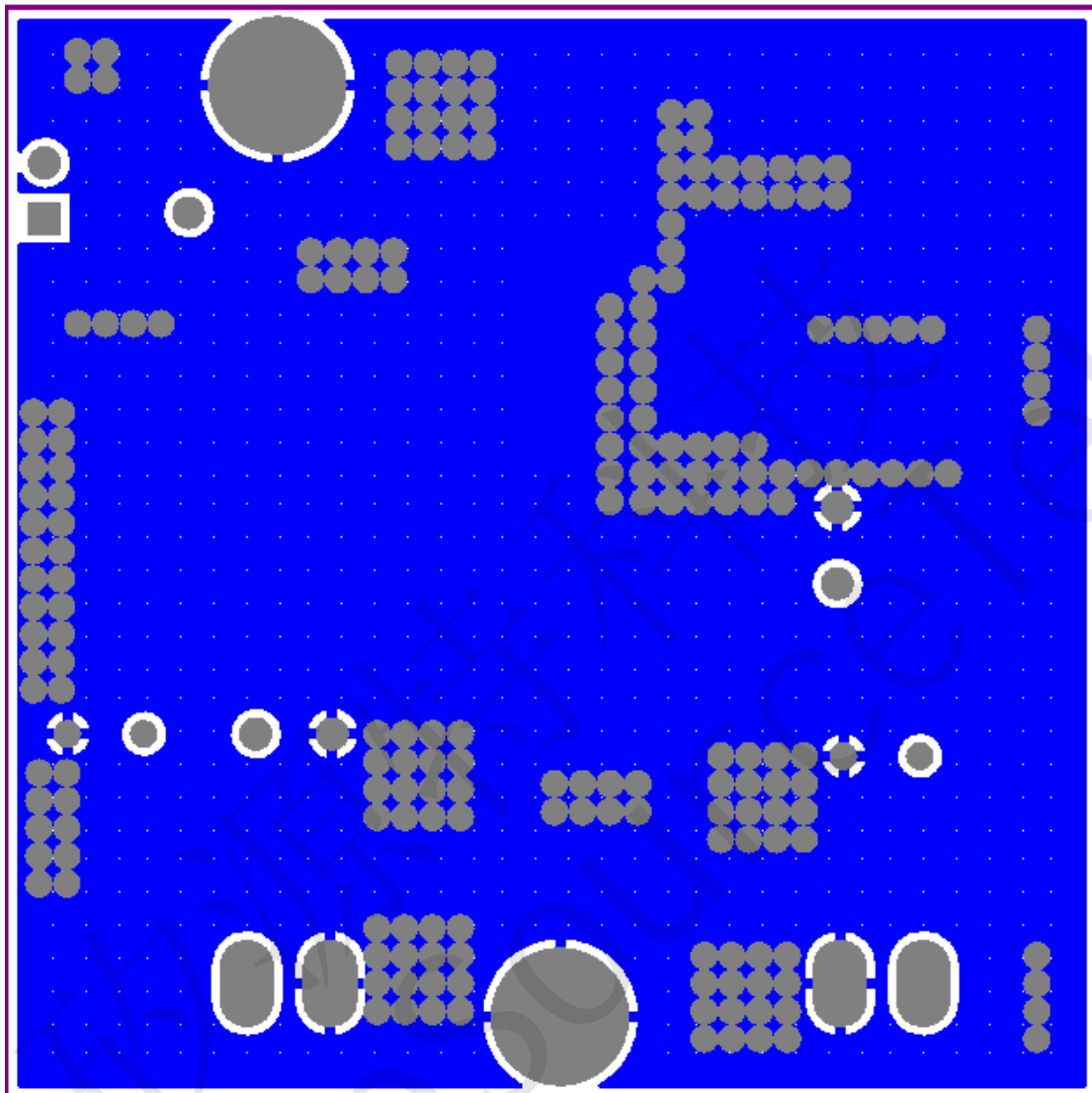



HT7182 21V, 14A高效升压转换器/21V, 14A Boost Converter

■ HT7182 PACKAGE OUTLINE

SPE (ESOP8)

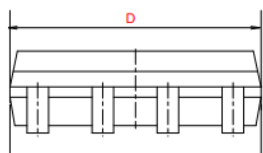
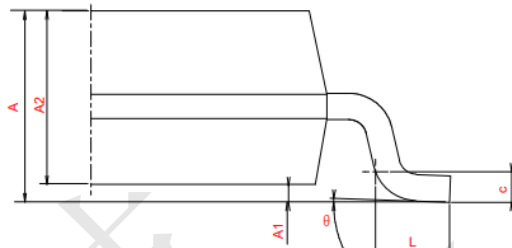
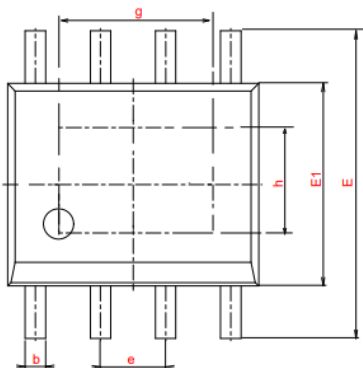

Symbol	Size (mm)	
	MIN	MAX
A	1.45	1.75
A1	0.05	0.15
A2	1.35	1.55
b	0.30	0.50
c	0.22	0.28
D	4.7	5.1
E	5.8	6.2
E1	3.85	4.05
L	0.4	1.27
h	2.4	
g	3.3	
e	1.27(BSC)	
θ	0°	8°



HT7182 21V, 14A高效升压转换器/21V, 14A Boost Converter

IMPORTANT NOTICE

注意

ShenZhen ChipSourceTek Technology Co.,Ltd. (Our company) reserves the right to make corrections, modifications, enhancements, improvements, and other changes to its products and services at any time and to discontinue any products or services. Customers should obtain the latest relevant information before placing orders and should verify that such information is current and complete.

深圳市矽源特科技有限公司（以下简称本司）保留对产品、服务、文档的任何修改、更正、提高、改善和其他改变，或停止提供任何产品和服务的权利。客户在下单和生产前应确保所获得的信息是最新、最完整的。

Our company assumes no liability for applications assistance or customer product design. Customers are responsible for their products and applications using Our company components.

本司对相关应用的说明和协助以及客户产品的板级设计不承担任何责任。

Our company products are not authorized for use in safety-critical applications (such as life support devices or systems) where a failure of the Our company product would reasonably be expected to affect the safety or effectiveness of that devices or systems.

本司的产品并未授权用于诸如生命维持设备等安全性极高的应用中。

The information included herein is believed to be accurate and reliable. However, Our company assumes no responsibility for its use; nor for any infringement of patents or other rights of third parties which may result from its use.

本文中的相关信息是精确和可靠的，但本司并不对其负责，也不对任何可能的专利和第三方权利的侵害负责。