



N-Channel Enhancement Mode Power MOSFET

Description

The PE8120HM1 uses advanced trench technology to provide excellent $R_{DS(ON)}$ and low gate charge. It can be used in a wide variety of applications. It is ESD protected.

General Features

- $V_{DS} > 12V$, $I_D = 20A$

$$R_{DS(ON)} < 4.6m\Omega @ V_{GS}=4.5V$$

$$R_{DS(ON)} < 5.0m\Omega @ V_{GS}=3.8V$$

$$R_{DS(ON)} < 5.5m\Omega @ V_{GS}=3.0V$$

$$R_{DS(ON)} < 6.5m\Omega @ V_{GS}=2.5V$$

ESD Rating: 4000V HBM

- High Power and current handing capability
- Lead free product is acquired
- Surface Mount Package

Application

- PWM applications
- Load switch
- Power management

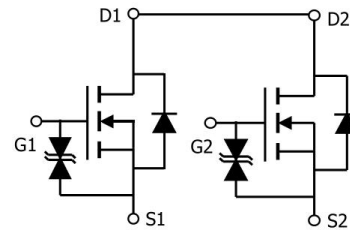

Schematic diagram

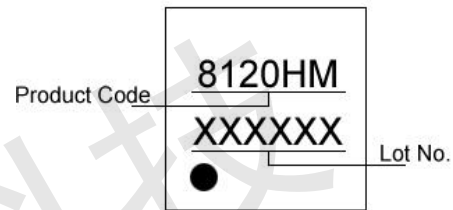

Marking

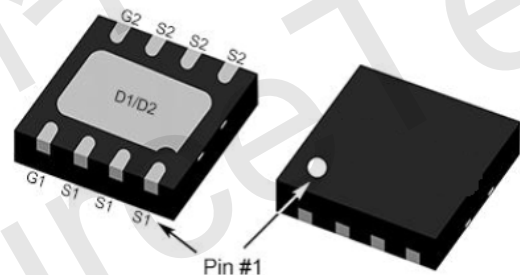

DFN3x3-8L

Absolute Maximum Ratings (TA=25°C unless otherwise noted)

Parameter	Symbol	Rating	Unit
Drain-Source Voltage	V_{DS}	12	V
Gate-Source Voltage	V_{GS}	±8	V
Drain Current-Continuous	I_D	TA=25°C	20
		TA=70°C	14
Pulsed Drain Current (Note 1)	I_{DM}	70	A
Maximum Power Dissipation	P_D	TA=25°C	3.6
		TA=70°C	2.4
Operating Junction and Storage Temperature Range	T_J, T_{STG}	-55 To 150	°C

Thermal Characteristic

Thermal Resistance, Junction-to-Ambient (Note 2)	$R_{\theta JA}$	35	°C/W
--	-----------------	----	------



Electrical Characteristics (TA=25°C unless otherwise noted)

Parameter	Symbol	Condition	Min	Typ	Max	Unit
Off Characteristics						
Drain-Source Breakdown Voltage	BV_{DSS}	$V_{GS}=0V, I_D=250\mu A$	12	15	-	V
Zero Gate Voltage Drain Current	I_{DSS}	$V_{DS}=12V, V_{GS}=0V$	-	-	1	μA
Gate-Body Leakage Current	I_{GSS}	$V_{GS}=\pm 6V, V_{DS}=0V$	-	-	± 5	μA
On Characteristics (Note 3)						
Gate Threshold Voltage	$V_{GS(th)}$	$V_{DS}=V_{GS}, I_D=250\mu A$	0.4	0.65	0.9	V
Drain-Source On-State Resistance	$R_{DS(on)}$	$V_{GS}=4.5V, I_D=8A$	2.7	3.6	4.6	m Ω
		$V_{GS}=3.8V, I_D=7A$	2.8	3.8	5.0	m Ω
		$V_{GS}=3.0V, I_D=6A$	3.3	4.4	5.5	m Ω
		$V_{GS}=2.5V, I_D=6A$	3.5	5.0	6.5	m Ω
Forward Transconductance	g_{FS}	$V_{DS}=5V, I_D=5A$	-	34	-	S
Dynamic Characteristics (Note 4)						
Input Capacitance	C_{iss}	$V_{DS}=10V, V_{GS}=0V,$ $F=1.0MHz$	-	3100	-	pF
Output Capacitance	C_{oss}		-	720	-	pF
Reverse Transfer Capacitance (Note 4)	C_{rss}		-	690	-	pF
Gate Resistance	R_g	$V_{DS}=0V, V_{GS}=0V, F=1.0MHz$	-	4	-	Ω
Switching Characteristics						
Turn-on Delay Time	$t_{d(on)}$	$V_{DD}=10V, R_L=1\Omega,$ $V_{GS}=4.5V, R_G=3\Omega$	-	15	-	nS
Turn-on Rise Time	t_r		-	30	-	nS
Turn-Off Delay Time	$t_{d(off)}$		-	52	-	nS
Turn-Off Fall Time	t_f		-	13	-	nS
Total Gate Charge	Q_g	$V_{DS}=10V, I_D=7A, V_{GS}=4.5V$	-	26	-	nC
Gate-Source Charge	Q_{gs}		-	2.8	-	nC
Gate-Drain Charge	Q_{gd}		-	8	-	nC
Drain-Source Diode Characteristics						
Diode Forward Voltage (Note 3)	V_{SD}	$V_{GS}=0V, I_S=1A$	-	-	1.2	V
Diode Forward Current (Note 2)	I_S		-	-	20	A

Notes:

1. Repetitive Rating: Pulse width limited by maximum junction temperature.
2. Surface Mounted on FR4 Board, $t \leq 10$ sec.
3. Pulse Test: Pulse Width $\leq 300\mu s$, Duty Cycle $\leq 2\%$.
4. Guaranteed by design, not subject to product.



Typical Electrical and Thermal Characteristics

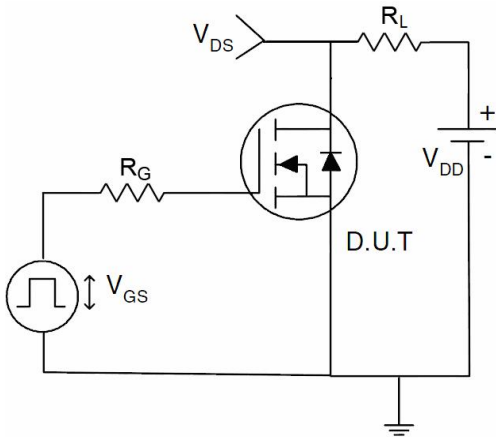

Figure 1 Switching Test Circuit

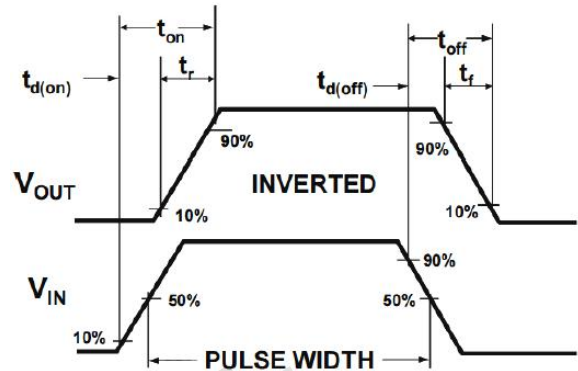

Figure 2 Switching Waveform

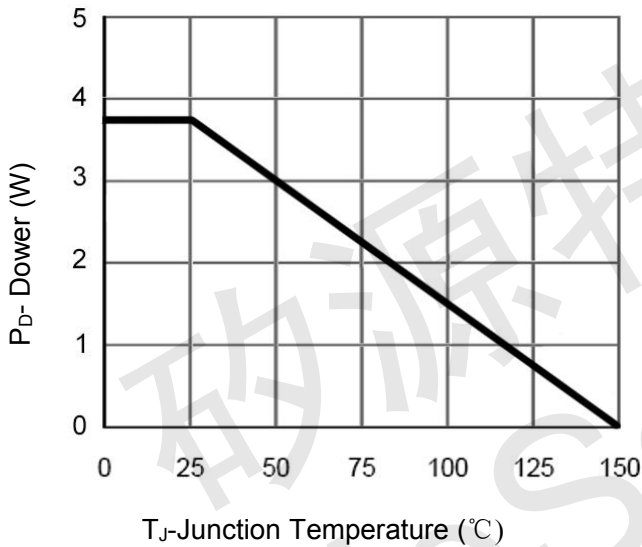

Figure 3 Power Dissipation

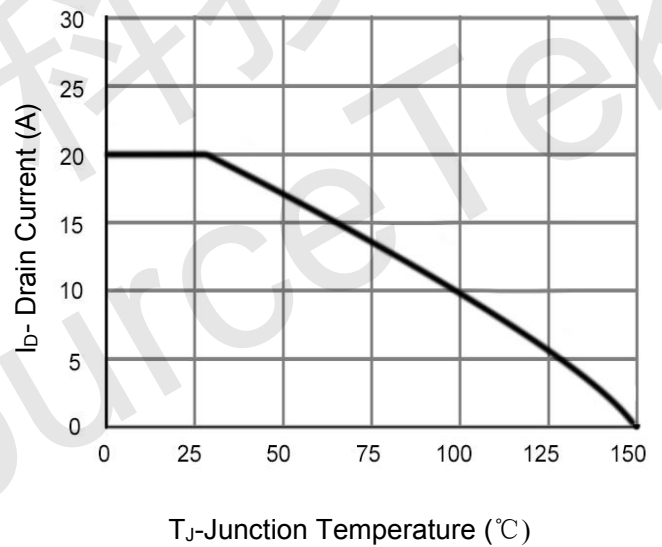

Figure 4 Drain Current

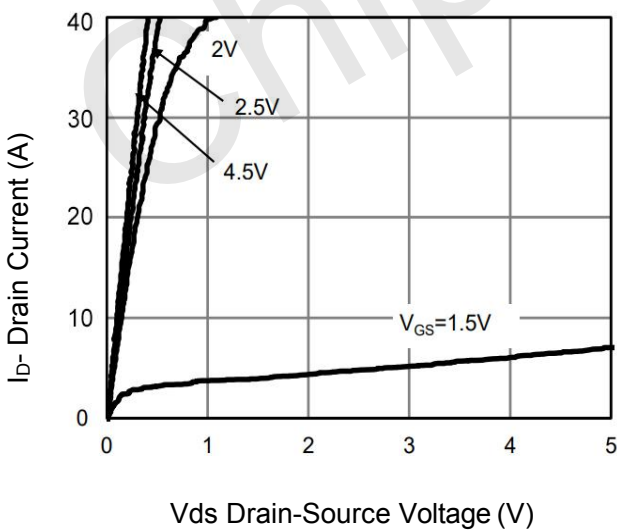

Figure 5 Output Characteristics

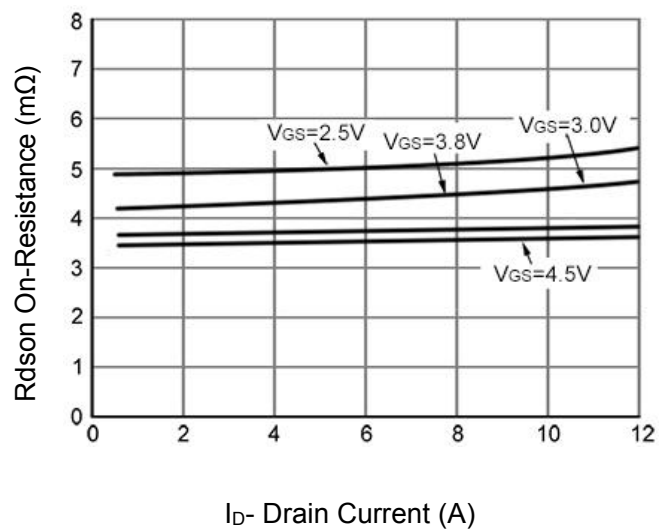

Figure 6 R_dson vs Drain Current

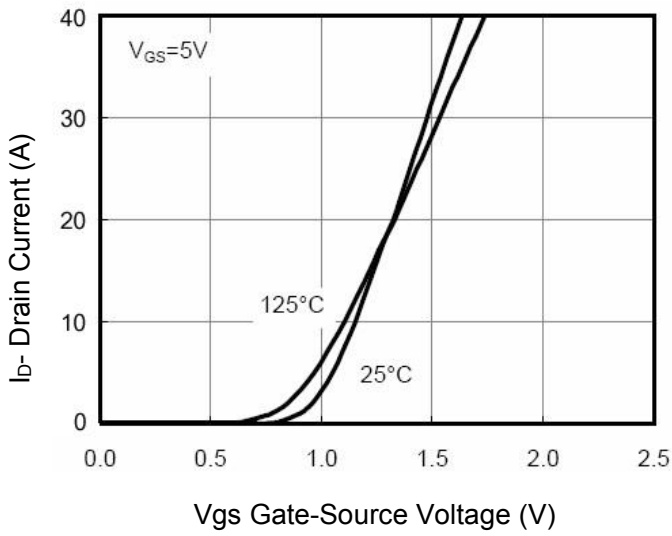

Figure 7 Transfer Characteristics

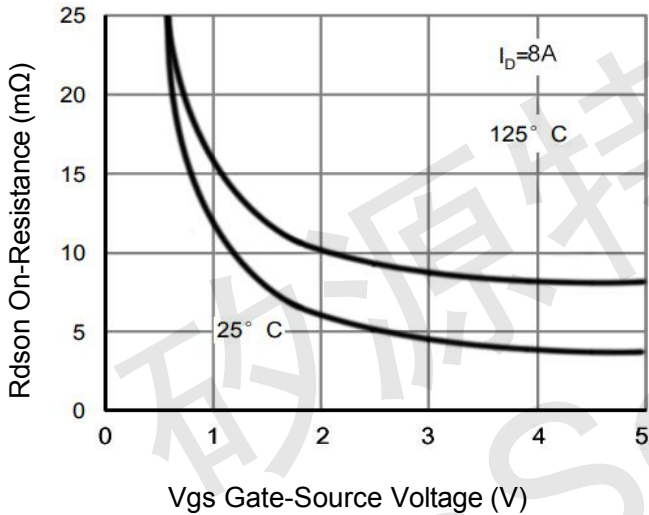

Figure 9 Rdson vs Vgs

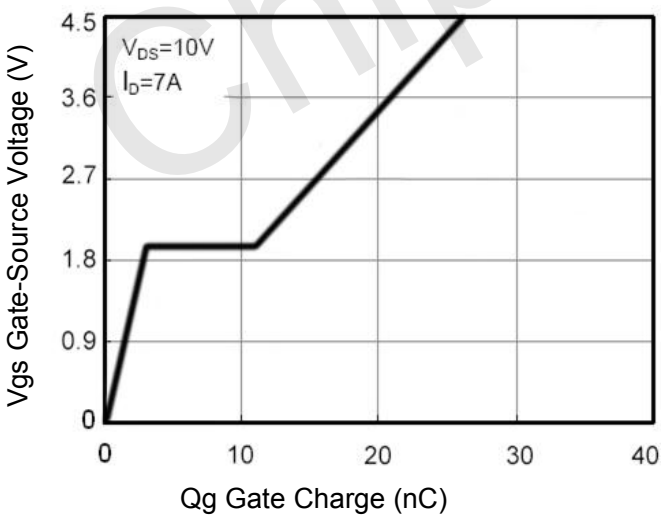

Figure 11 Gate Charge

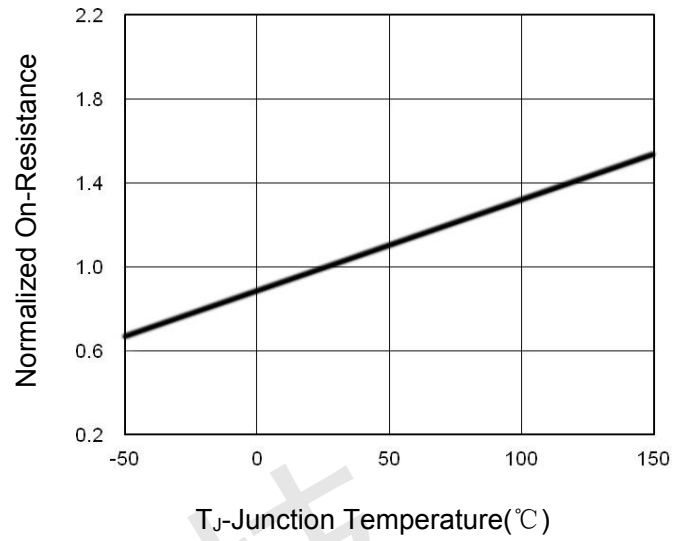

Figure 8 Rdson vs Junction Temperature

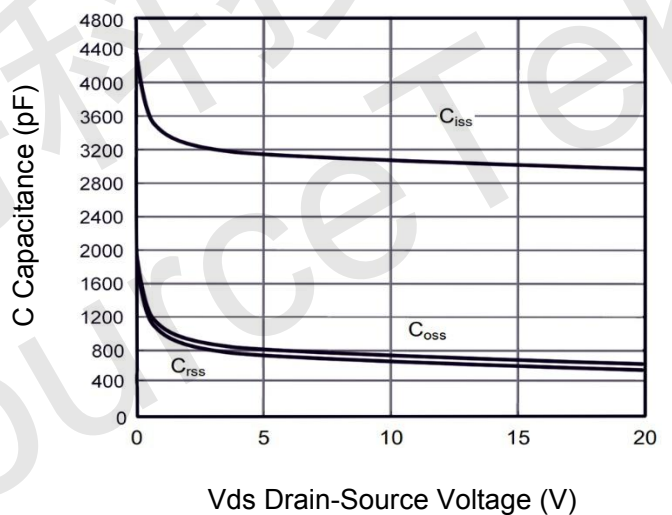

Figure 10 Capacitance vs Vds

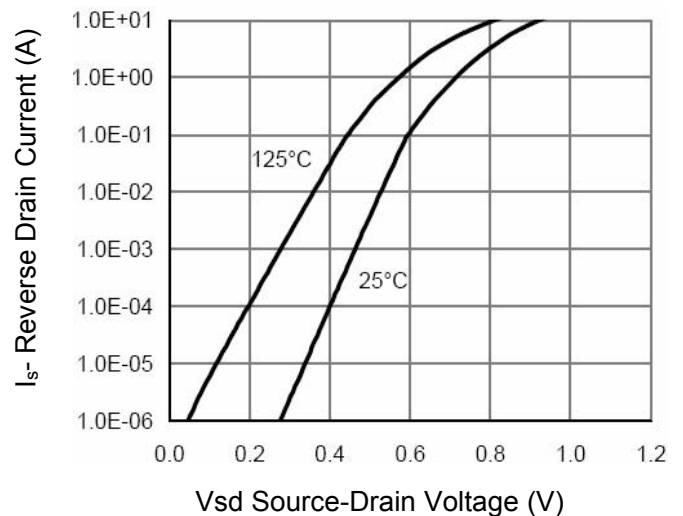

Figure 12 Source- Drain Diode Forward

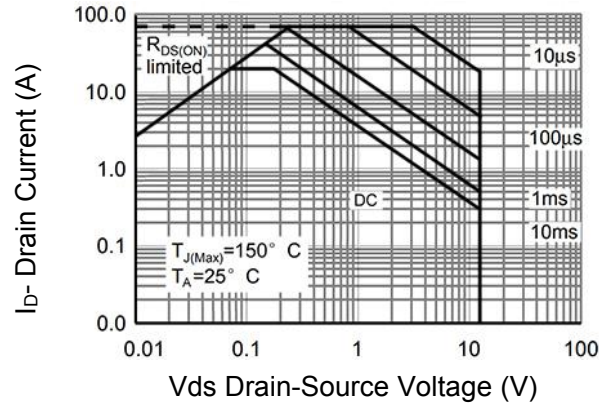

Figure 13 Safe Operation Area

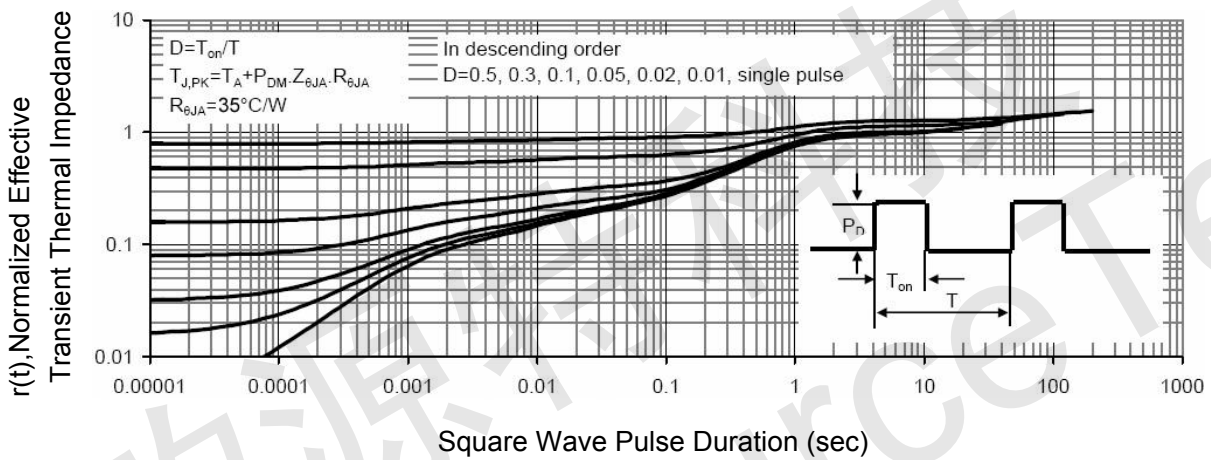
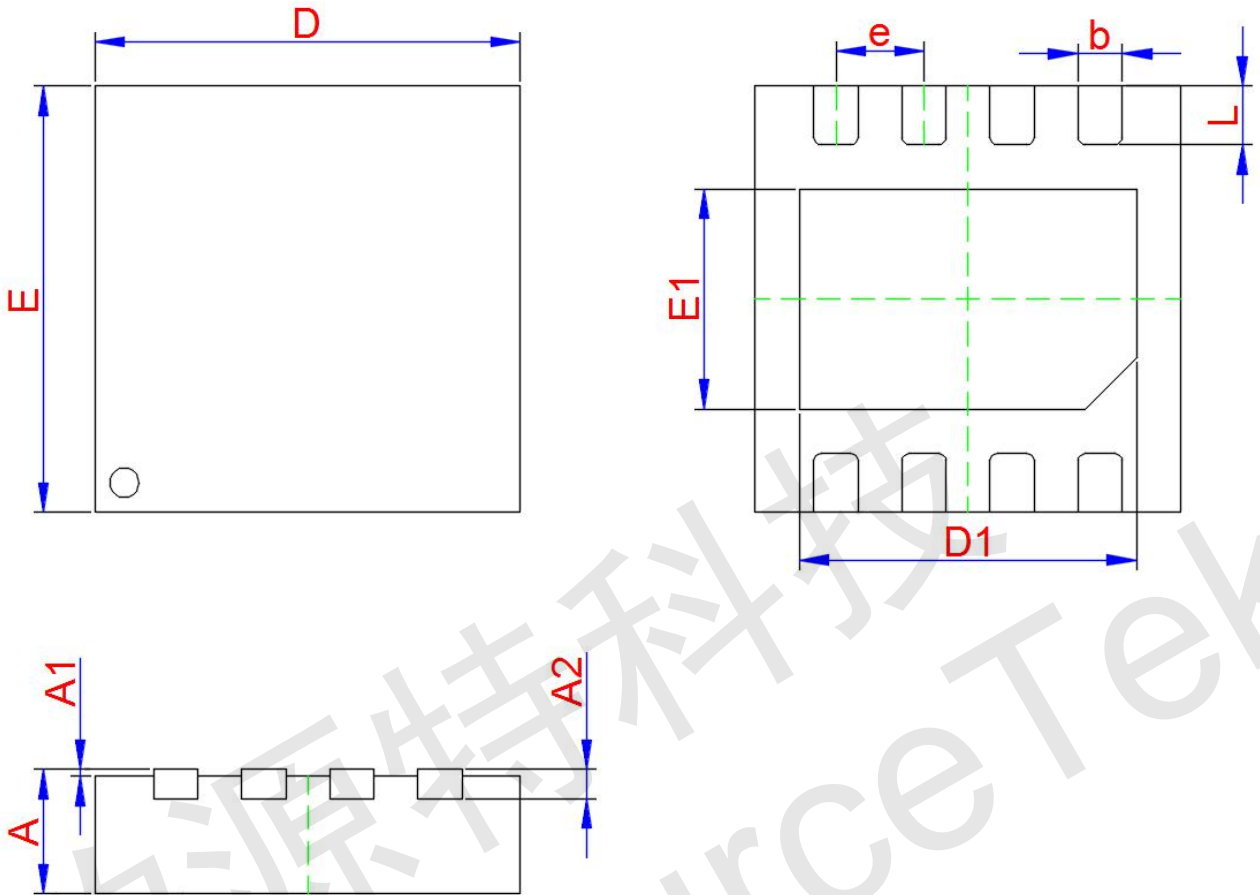

Figure 14 Normalized Maximum Transient Thermal Impedance



DFN3x3-8L Package Information



Symbol	Dimensions In Millimeters		
	Min.	Typ.	Max.
A	0.700	0.750	0.800
A1	0.000	0.020	0.050
A2	0.203		
b	0.250	0.300	0.350
D	2.924	3.000	3.076
D1	2.200	2.300	2.400
E	2.924	3.000	3.076
E1	1.400	1.500	1.600
e	0.650 TYP.		
L	0.350	0.400	0.450