



1.2MHz 2A Synchronous Step-Down Regulator

R Y3420 Features

- High Efficiency: Up to 96%
- 2.5V to 5.5V Input Voltage Range
- 1.2MHz Constant Frequency Operation
- No Schottky Diode Required
- Low Dropout Operation: 100% Duty Cycle
- PFM Mode for High Efficiency in Light Load
- Over Temperature Protected
- Low Quiescent Current: 40 μ A
- Short Circuit Protection
- Inrush Current Limit and Soft Start
- 2A Continuous Output Current
- SOT23-5 package

R Y3420 Applications

- Cellular and Smart Phones
- Wireless and DSL Modems
- PDAs
- Portable Instruments
- Digital Still and Video Cameras
- PC Cards

R Y3420 General Description

The RY3420 is a high-efficiency monolithic synchronous buck regulator using a constant frequency, current mode architecture. The device is available in an adjustable version. Supply current with no load is 40 μ A and drops to <1 μ A in shutdown. The 2.3V to 6V input voltage range makes the RY3420 ideally suited for single Li-Ion battery powered applications. 100% duty cycle provides low dropout operation, extending battery life in portable systems. PWM/PFM mode operation provides very low output ripple voltage for noise sensitive applications. Switching frequency is internally set at 1.2MHz, allowing the use of small surface mount inductors and capacitors. Low output voltages are easily supported with the 0.6V feedback reference voltage. The RY3420 is offered in a low profile (1mm) 5-pin, thin SOT package, and is available in an adjustable version.

R Y3420 Typical Application Circuit

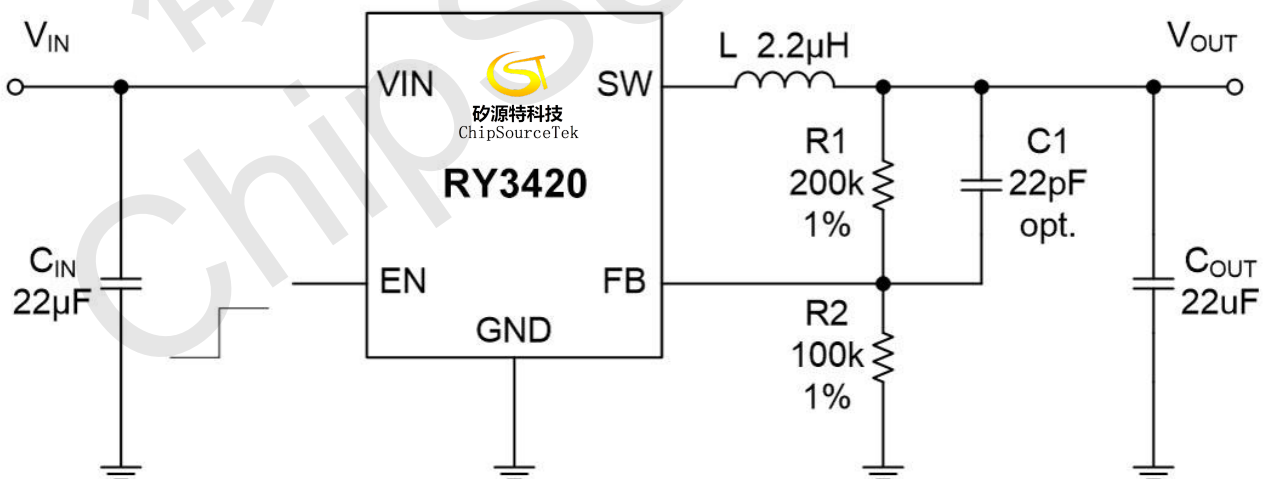



1.2MHz 2A Synchronous Step-Down Regulator

R Y3420 Absolute Maximum Ratings (Note 1)

Input Supply Voltage -0.3V to 6.0V
EN, FB Voltages..... -0.3V to 6.0V
SW Voltage..... -0.3V to (Vin+0.3V)
Peak SW Sink and Source Current 3A

Operating Temperature Range -40°C to +85°C
Junction Temperature(Note2) 125°C
Storage Temperature Range -65°C to 150°C
Lead Temperature(Soldering,10s)..... +300°C

R Y3420 Pin Description

Pin Configuration

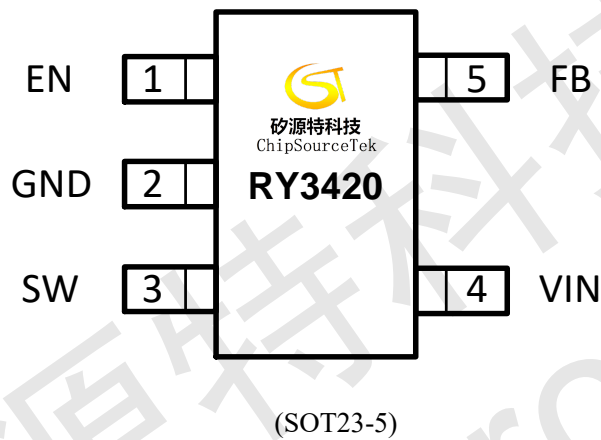

Pin Description

Pin	Name	Function
1	EN	Chip Enable Pin. Drive EN above 1.5V to turn on the part. Drive EN below 0.3V to turn it off. Do not leave EN floating.
2	GND	Ground Pin
3	SW	Power Switch Output. It is the switch node connection to Inductor. This pin connects to the drains of the internal P-ch and N-ch MOSFET switches.
4	VIN	Power Supply Input. Must be closely decoupled to GND with a 10μF or greater ceramic capacitor.
5	FB	Output Voltage Feedback Pin. An internal resistive divider divides the output voltage down for comparison to the internal reference voltage.

R Y3420 Order Information

Part No.	Model	Description	Package	MOQ
70301003	RY3420	RY3420 Buck, 2.5-5.5V, 2A, 1.2MHz, VFB 0.6V, SOT23-5	SOT23-5	3000PCS



1.2MHz 2A Synchronous Step-Down Regulator

RY3420 Electrical Characteristics (Note 3)

($V_{IN}=V_{EN}=3.6V$, $T_A = 25^\circ C$, unless otherwise noted.)

Parameter	Conditions	Min.	Typ.	Max.	Unit
Input Voltage Range		2.3		6.0	V
UVLO Threshold			2.4		V
Input DC Supply Current	FB = 90%, Iload=0mA		150	300	μA
	FB= 105%, Iload=0mA		40	70	μA
	$V_{EN} = 0V$, $V_{IN}=4.2V$		0.1	1.0	μA
Regulated Feedback Voltage	$T_A = 25^\circ C$	0.588	0.600	0.612	V
Reference Voltage Line Regulation	$V_{in} = 2.5V$ to $6.0V$		0.04	0.40	%/V
Output Voltage Line Regulation	$V_{IN} = 2.5V$ to $6.0V$		0.04	0.4	%
Output Voltage Load Regulation			0.5		%
Oscillation Frequency			1.2		MHz
On Resistance of PMOS	$I_{SW}=100mA$		0.1		Ω
ON Resistance of NMOS	$I_{SW}=-100mA$		0.08		Ω
Peak Current Limit	$V_{IN}= 3.6V$, FB=90%	2.8			A
EN Threshold		0.30	1.0	1.50	V
EN Leakage Current			± 0.01	± 1.0	μA
SW Leakage Current	$V_{EN}=0V, V_{IN}=V_{SW}=5V$		± 0.01	± 1.0	μA
Thermal Shutdown			160		$^\circ C$

Note 1: Absolute Maximum Ratings are those values beyond which the life of a device may be impaired.

Note 2: T_J is calculated from the ambient temperature T_A and power dissipation PD according to the following formula: $T_J = T_A + (PD) \times (250^\circ C/W)$.

Note3: 100% production test at $+25^\circ C$. Specifications over the temperature range are guaranteed by design and characterization.



1.2MHz 2A Synchronous Step-Down Regulator

R_Y3420 Functional Block Diagram

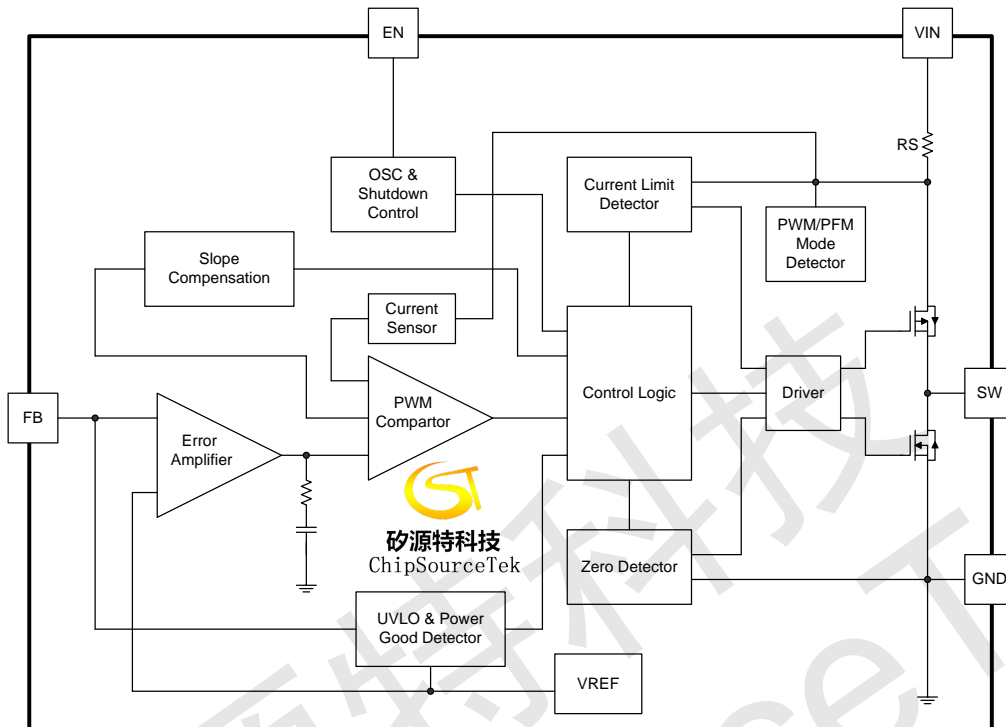

Figure 1. R_Y3420 Block Diagram

R_Y3420 Operation

The Y3420 uses a constant frequency, current mode step-down architecture. Both the main (P-channel MOSFET) and synchronous (N-channel MOSFET) switches are internal. During normal operation, the internal top power MOSFET is turned on each cycle when the oscillator sets the RS latch, and turned off when the current comparator, ICOMP, resets the RS latch. The peak inductor current at which ICOMP resets the RS latch, is controlled by the output of error amplifier EA. When the load current increases, it causes a slight decrease in the feedback voltage, FB, relative to the 0.6V reference, which in turn, causes the EA amplifier's output voltage to increase until the average inductor current matches the new load current. While the top MOSFET is off, the bottom MOSFET is turned on until either the inductor current starts to reverse, as indicated by the current reversal comparator IRCMP, or the beginning of the next clock cycle.



1.2MHz 2A Synchronous Step-Down Regulator

R_Y3420 Typical Performance Characteristics

EFFICIENCY VS OUTPUT CURRENT (V_{OUT}=3.3V)

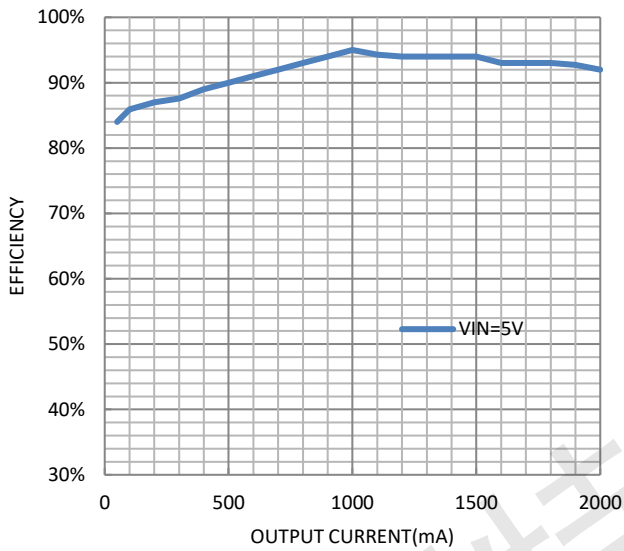

OUTPUT VOLTAGE VS OUTPUT CURRENT (V_{OUT}=3.3V)

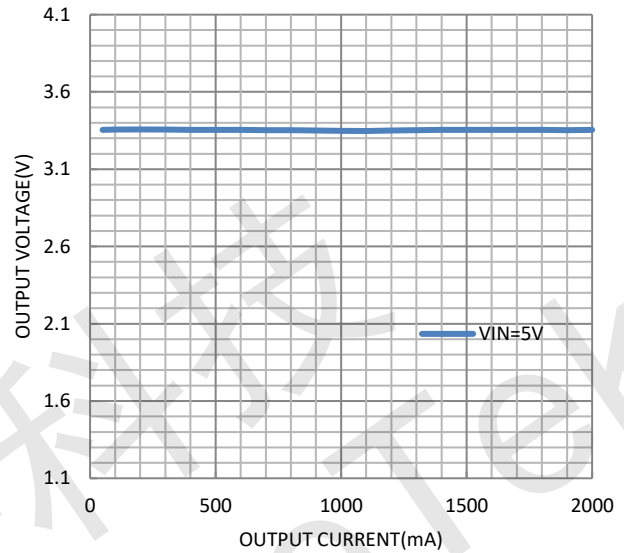

LOAD TRANSIENT RESPONSE
(V_{IN}=5V, V_{OUT}=3.3V, I_{OUT}=500-1500mA, 1A/μS)

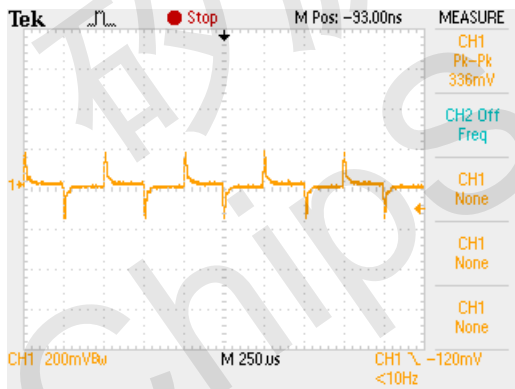

STRAT UP
(V_{IN}=5V, V_{OUT}=3.3V)

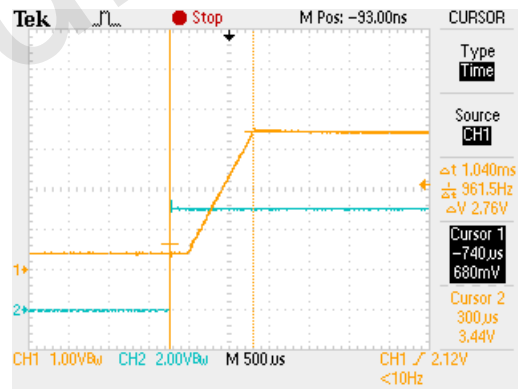



1.2MHz 2A Synchronous Step-Down Regulator

Ry3420 Applications Information

Setting the Output Voltage

In the adjustable version, the output voltage is set by a resistive divider according to the following formula:

$$R_2 = \frac{R_1}{V_{OUT} / V_{FB} - 1}$$

The external resistive divider is connected to the output, allowing remote voltage sensing as shown in on page 1.

Inductor Selection

For most designs, the Ry3420 operates with inductors of 1μH to 4.7μH. Low inductance values are physically smaller but require faster switching, which results in some efficiency loss. The inductor value can be derived from the following equation:

$$L = \frac{V_{OUT} \times (V_{IN} - V_{OUT})}{V_{IN} \times \Delta I_L \times f_{OSC}}$$

Where ΔI_L is inductor Ripple Current. Large value inductors result in lower ripple current and small value inductors result in high ripple current. For optimum voltage-positioning load transients, choose an inductor with DC series resistance in the 50mΩ to 150mΩ range.

Input Capacitor Selection

Higher values, lower cost ceramic capacitors are now becoming available in smaller case sizes. Their high ripple current, high voltage rating and low ESR make them ideal for switching regulator applications. Because the Ry3420's control loop does not depend on the output capacitor's ESR for stable operation, ceramic capacitors can be used freely to achieve very low output ripple and small circuit size. However, care must be taken when ceramic capacitors are used at the input and the output. When a ceramic capacitor is used at the input and the power is supplied by a wall adapter through long wires, a load step at the output can induce ringing at the input, VIN. At best, this ringing can couple to the output and be mistaken as loop instability. At worst, a sudden inrush of current through the long wires can potentially cause a voltage spike at VIN, large enough to damage the part. When choosing the input and output ceramic capacitors, choose the X5R or X7R dielectric formulations. These dielectrics have the best temperature and voltage characteristics of all the ceramics for a given value and size.

PC Board Layout Checklist

When laying out the printed circuit board, the following checking should be used to ensure proper operation of the Ry3420. Check the following in your layout:

1. The power traces, consisting of the GND trace, the SW trace and the VIN trace should be kept short, direct and wide.
2. Does the (+) plates of Cin connect to Vin as closely as possible? This capacitor provides the AC current to the internal power MOSFETs.
3. Keep the switching node, SW, away from the sensitive VOUT node.
4. Keep the (-) plates of Cin and Cout as close as possible



1.2MHz 2A Synchronous Step-Down Regulator

R_Y3420 Package Description

SOT23-5

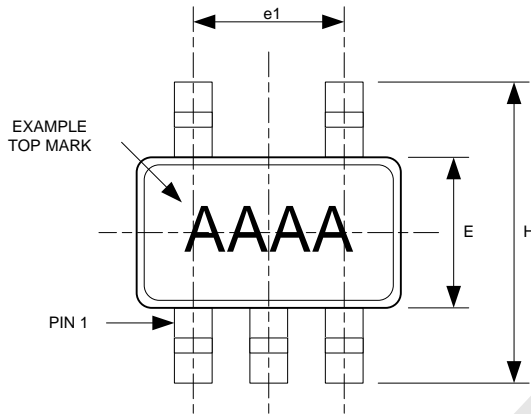

5LD SOT-23 PACKAGE OUTLINE DIMENSIONS

Dimension	Min.	Max.
A	1.05	1.35
A1	0.04	0.15
B	0.3	0.5
C	0.09	0.2
D	2.8	3.0
H	2.5	3.1
E	1.5	1.7
e	0.95 REF.	
e1	1.90 REF.	
L1	0.2	0.55
L	0.35	0.8
Q	0°	10°

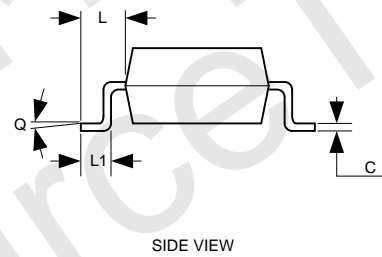
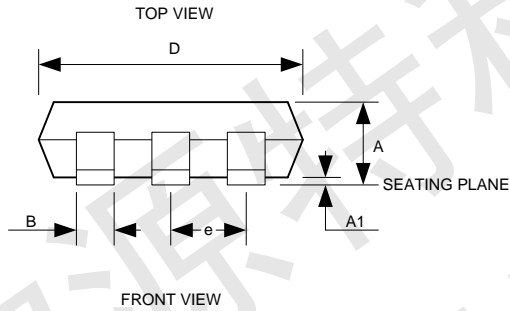

- NOTE:
- 1.DIMENSIONS ARE IN MILLIMETERS
 - 2.DRAWING NOT TO SCALE
 - 3.DIMENSIONS ARE INCLUSIVE OF PLATING
 - 4.DIMENSIONS ARE EXCLUSIVE OF MOLD FLASH AND METAL BURR