



SLS50N03 N-Channel 30V/50A Enhancement Mode Power MOSFET

SLS50N03 Description

This Power SLS50N03 is produced using advanced TRENCH technology.

This advanced technology has been especially tailored to Minimize conduction loss , provide superior switching performance , and withstand high energy pulse in the avalanche and commutation mode.

SLS50N03 General Features

- $V_{DS} = 30V$, $I_D = 50A$
- $R_{DS(ON)} (TYP) = 7m\Omega @ V_{GS}=10V$
- $R_{DS(ON)} (TYP) = 10m\Omega @ V_{GS}=4.5V$
- Very Low On-resistance $R_{DS(ON)}$
- Low C_{rss}
- Fast switching
- 100% avalanche tested

SLS50N03 Application

- PWM applications
- Load switch
- Power management

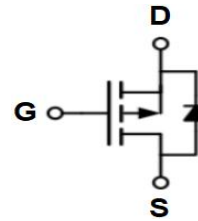

Schematic diagram

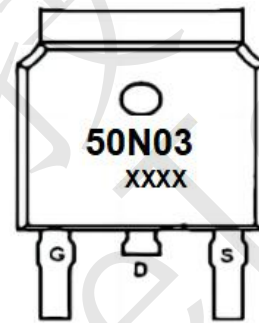

Marking and pin assignment

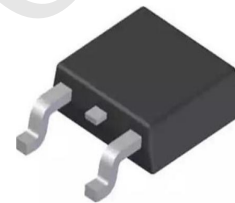

TO-252-2L

SLS50N03 Absolute Maximum Ratings (TA=25°C unless otherwise noted)

Symbol	Parameter	Rating	Units
V_{DSS}	Drain-Source Voltage	30	V
I_D	Drain Current - Continuous ($T_C = 25^\circ C$) - Continuous ($T_C = 100^\circ C$)	50	A
		30	A
I_{DM}	Drain Current - Pulsed (Note 1)	120	A
V_{GSS}	Gate-Source Voltage	± 20	V
E_{AS}	Single Pulsed Avalanche Energy (Note 2)	39	mJ
E_{AR}	Repetitive Avalanche Energy	-	mJ
dv/dt	Peak diode recovery dv/dt	-	V/ns
P_D	Power Dissipation ($T_C = 25^\circ C$)	18	W
$R_{\theta JC}$	Thermal Resistance, Junction to Case	4.32	W/°C
T_J, T_{STG}	Operating and Storage Temperature Range	-55 to +150	°C
T_L	Maximum lead temperature for soldering purposes, 1/8" from case for 5 seconds	300	°C

* Drain current limited by maximum junction temperature.



SLS50N03 Electrical Characteristics (TA=25°C unless otherwise noted)

Symbol	Parameter	Test Conditions	Min	Typ	Max	Units
Off Characteristics						
BV _{DSS}	Drain-Source Breakdown Voltage	V _{GS} = 0 V, I _D = 250 uA	30	--	--	V
I _{DSS}	Zero Gate Voltage Drain Current	V _{DS} = 30 V, V _{GS} = 0 V	--	--	1	uA
		V _{DS} = 24V, T _C = 125°C	--	--	10	uA
I _{GSSF}	Gate-Body Leakage Current, Forward	V _{GS} = 20V, V _{DS} = 0 V	--	--	100	nA
I _{GSSR}	Gate-Body Leakage Current, Reverse	V _{GS} = -20 V, V _{DS} = 0 V	--	--	-100	nA
On Characteristics						
V _{GS(th)}	Gate Threshold Voltage	V _{DS} = V _{GS} , I _D = 250 uA	1.0	-	2.5	V
R _{DS(on)}	Static Drain-Source	V _{GS} = 10 V, I _D = 12A	--	7	8.5	mΩ
	On-Resistance	V _{GS} = 4.5 V, I _D = 10A	-	10	14	
Dynamic Characteristics						
C _{iss}	Input Capacitance	V _{DS} = 15 V, V _{GS} = 0 V, f = 1.0 MHz	--	1200	-	pF
C _{oss}	Output Capacitance		--	163	-	pF
C _{rss}	Reverse Transfer Capacitance		--	131	-	pF
Switching Characteristics						
t _{d(on)}	Turn-On Delay Time	V _{GS} = 10 V, V _{DS} = 12 V, R _G = 3.3Ω, I _D = 5A (Note 3)	--	4.5	--	ns
t _r	Turn-On Rise Time		--	10.8	--	ns
t _{d(off)}	Turn-Off Delay Time		--	25.5	--	ns
t _f	Turn-Off Fall Time		--	9.6	--	ns
Q _g	Total Gate Charge		--	12.8	--	nC
Q _{gs}	Gate-Source Charge	V _{DS} = 20 V, I _D = 12A, V _{GS} = 4.5V(Note 3)	--	3.3	--	nC
Q _{gd}	Gate-Drain Charge	--	6.5	--	nC	
Drain-Source Diode Characteristics and Maximum Ratings						
I _S	Maximum Continuous Drain-Source Diode Forward Current	--	--	--	50	A
I _{SM}	Maximum Pulsed Drain-Source Diode Forward Current	--	--	--	120	A
V _{SD}	Drain to Source Diode Forward Voltage, V _{GS} = 0V, I _{SD} = 5A, T _J = 25°C	--	--	--	1.2	V

Notes

1. Repetitive Rating: Pulse Width Limited by Maximum Junction Temperature
2. EAS condition: T_J = 25°C, V_{DD} = 20V, V_G = 10V, R_G = 25Ω, L = 0.1mH,
3. Pulse Test: Pulse Width ≤ 300μs, Duty Cycle ≤ 0.5%



SLS50N03 Typical Electrical and Thermal Characteristics

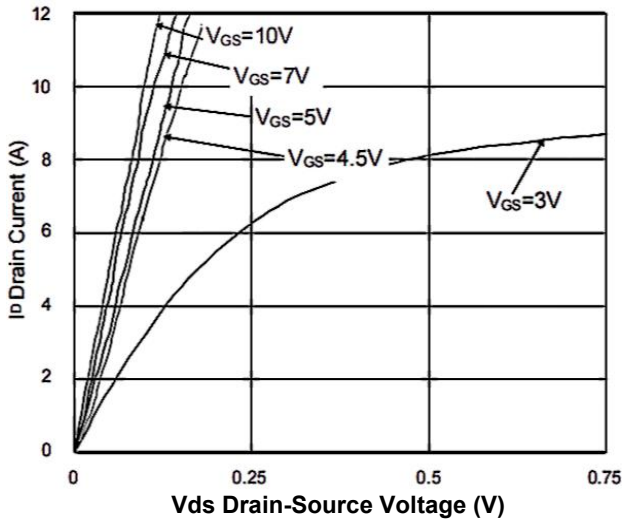

Figure.1 Typical Output Characteristics

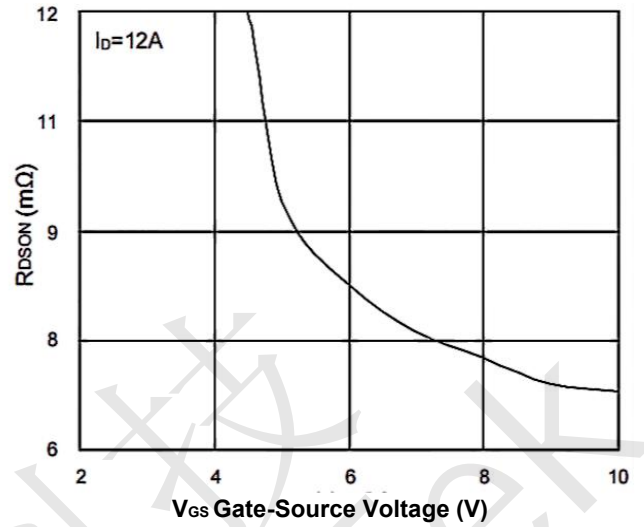

Figure 2. On-Resistance vs. G-S Voltage

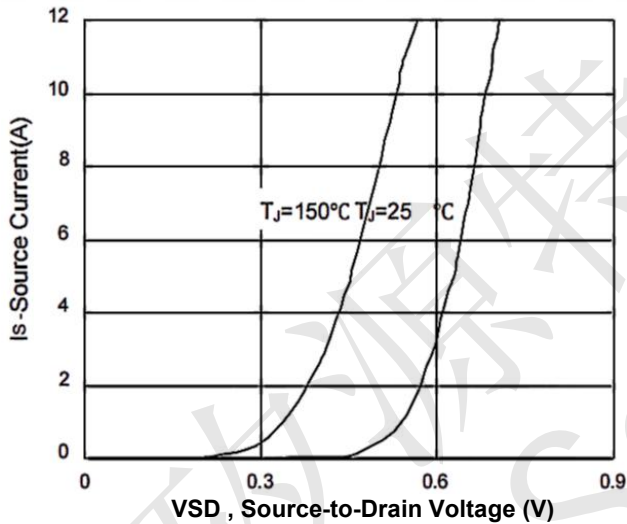

Figure 3. Forward Characteristics of Reverse

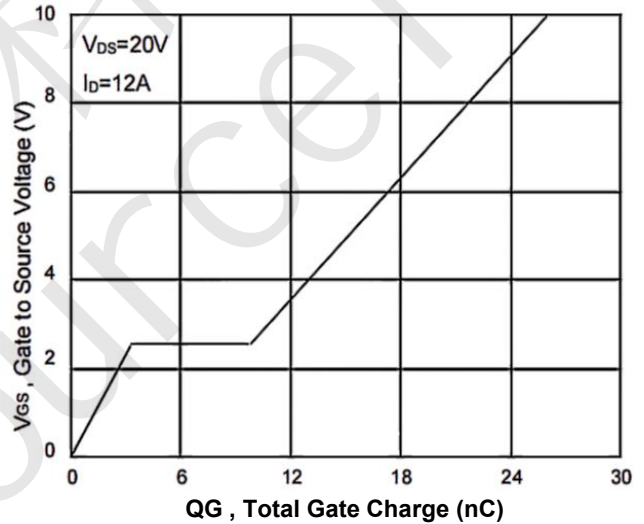

Figure 4. Gate-Charge Characteristics

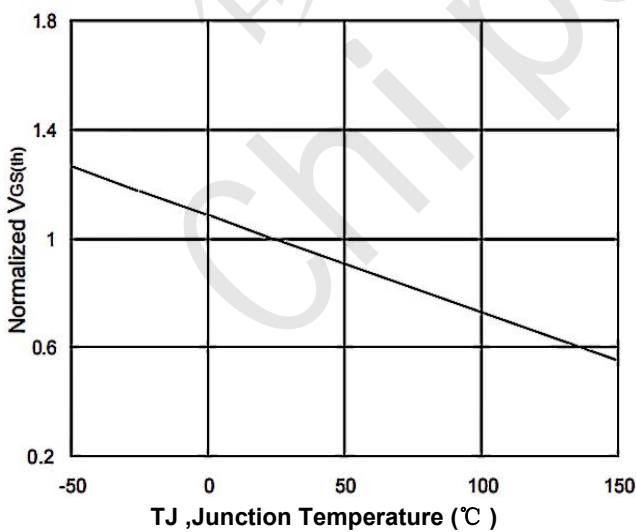

Figure 5. Normalized $V_{GS(th)}$ vs. T_J

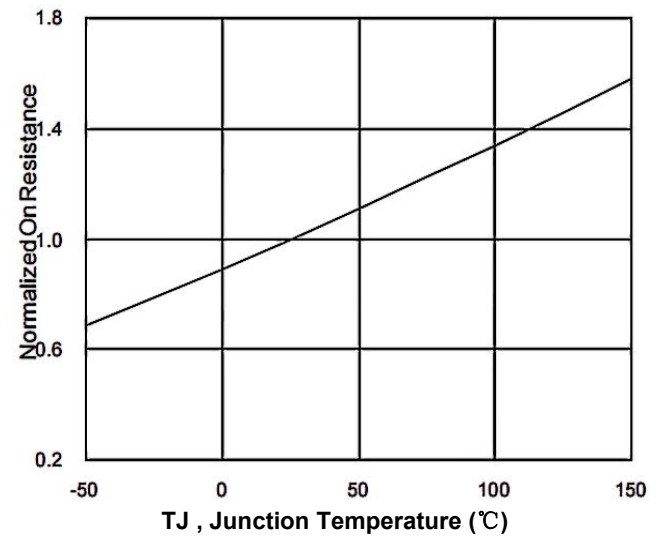
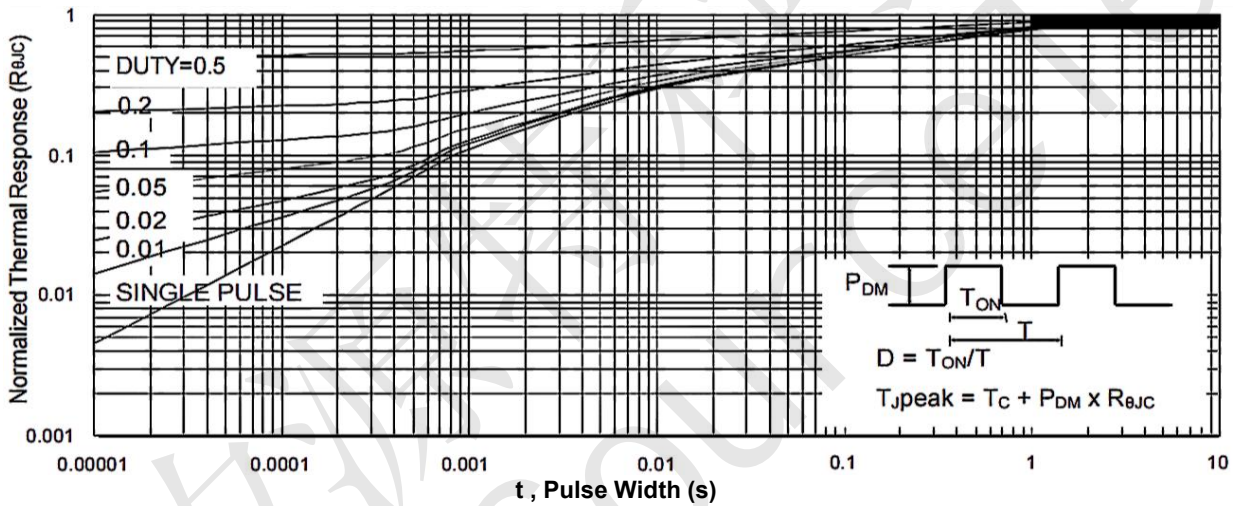
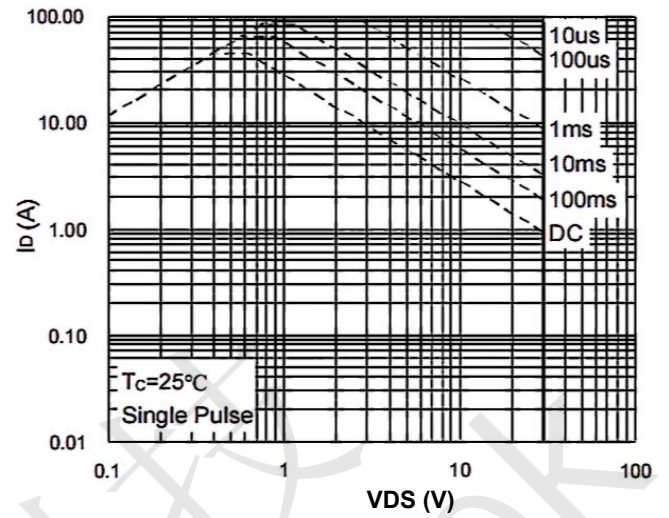
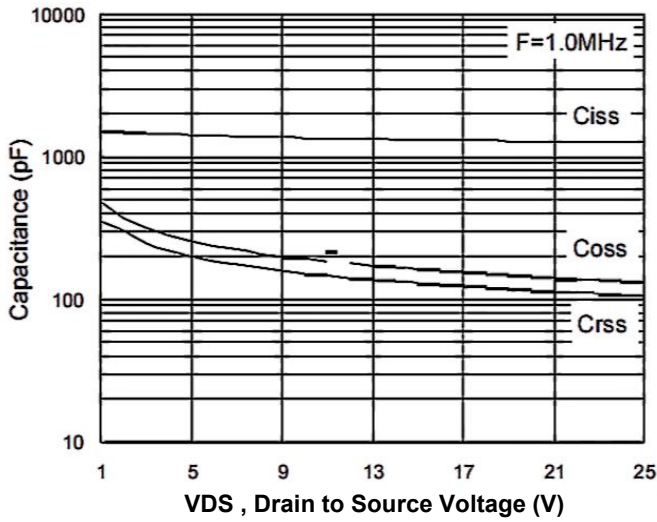
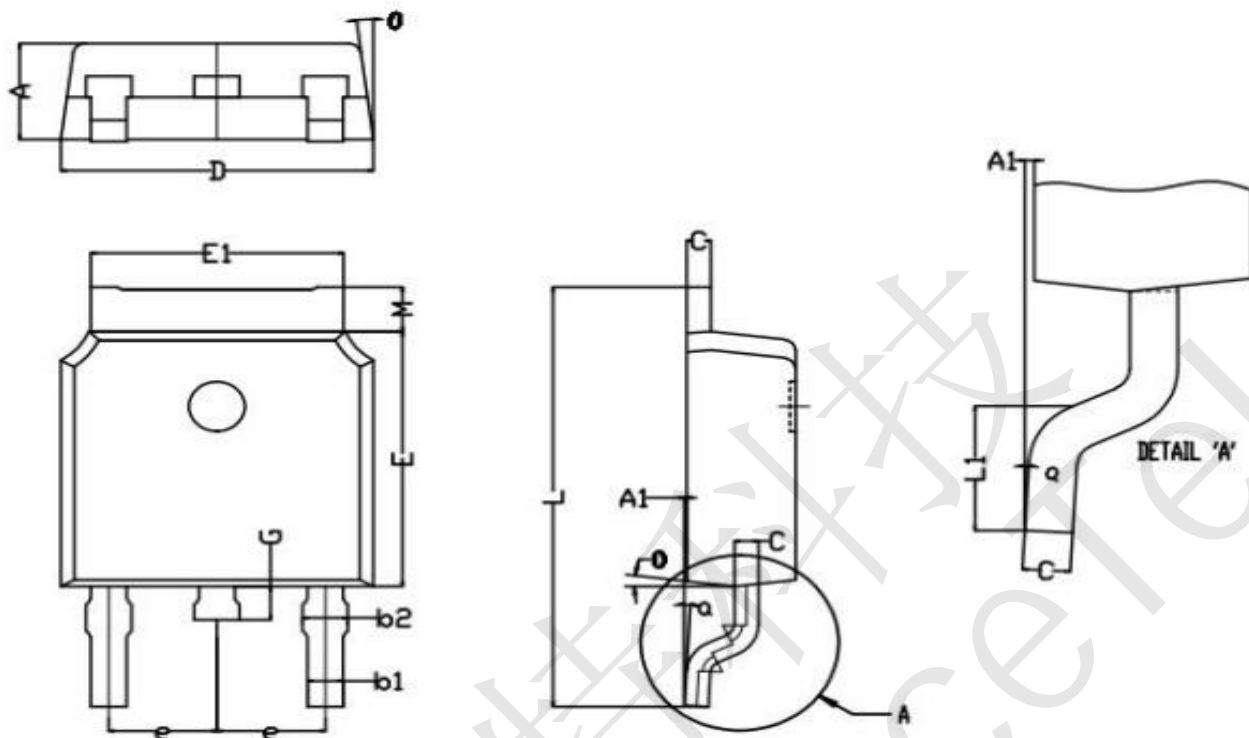

Figure 6. Normalized $R_{DS(on)}$ VS. T_J





SLS50N03 TO-252-2L Package Information



Symbol	Dim in mm		
	Min	Nor	Max
A	2.25	2.30	2.35
L1	2.90	3.00	3.10
b1	0.71	0.76	0.81
b2	0.91	0.96	1.01
C	0.46	0.51	0.56
D	6.55	6.60	6.65
e	2.29 (BSC)		
E	6.05	6.10	6.15
E1	5.23	5.33	5.43
L	9.84	10.04	10.24
A1	0.00	0.05	0.10
M	1.01	1.06	1.11
G	0.70	0.80	0.90
Q	0°	5°	10°
Q	0°	3°	6°



Information furnished in this document is believed to be accurate and reliable. However, Shenzhen ChipSourceTek Technology Co., LTD assumes no responsibility for the consequences of use without consideration for such information nor use beyond it.

Information mentioned in this document is subject to change without notice, apart from that when an agreement is signed, Shenzhen ChipSourceTek complies with the agreement.

Products and information provided in this document have no infringement of patents. Shenzhen ChipSourceTek assumes no responsibility for any infringement of other rights of third parties which may result from the use of such products and information.

This document supersedes and replaces all information previously supplied. is a registered trademark of Shenzhen ChipSourceTek Technology Co., LTD.