



## P-Channel Enhancement Mode Power MOSFET

### Description

The PE2305AL uses advanced trench technology to provide excellent  $R_{DS(ON)}$  and low gate charge. It can be used in a wide variety of applications.

### General Features

- $V_{DS} = -18V$ ,  $I_D = -4.5A$

$$R_{DS(ON)} < 45m\Omega @ V_{GS} = -4.5V$$

$$R_{DS(ON)} < 60m\Omega @ V_{GS} = -2.5V$$

- High Power and current handing capability
- Lead free product is acquired
- Surface Mount Package

### Application

- PWM applications
- Load switch
- Power management

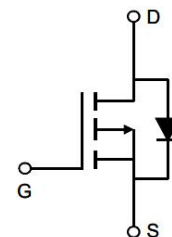

Schematic diagram

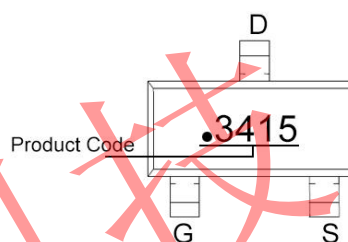

Marking and pin assignment



SOT-23

### Absolute Maximum Ratings (TA=25°C unless otherwise noted)

Parameter	Symbol	Rating	Unit
Drain-Source Voltage	$V_{DS}$	-18	V
Gate-Source Voltage	$V_{GS}$	$\pm 12$	V
Drain Current-Continuous	$I_D$	-4.5	A
Pulsed Drain Current (Note 1)	$I_{DM}$	-18	A
Maximum Power Dissipation	$P_D$	1.4	W
Operating Junction and Storage Temperature Range	$T_J, T_{STG}$	-55 To 150	°C

### Thermal Characteristic

Thermal Resistance, Junction-to-Ambient (Note 2)	$R_{\theta JA}$	90	°C/W
--	-----------------	----	------



**Electrical Characteristics (TA=25°C unless otherwise noted)**

Parameter	Symbol	Condition	Min	Typ	Max	Unit
<b>Off Characteristics</b>						
Drain-Source Breakdown Voltage	$BV_{DSS}$	$V_{GS}=0V, I_D=-250\mu A$	-	-18	-	V
Zero Gate Voltage Drain Current	$I_{DSS}$	$V_{DS}=-15V, V_{GS}=0V$	-	-	-1	$\mu A$
Gate-Body Leakage Current	$I_{GSS}$	$V_{GS}=\pm 10V, V_{DS}=0V$	-	-	$\pm 100$	nA
<b>On Characteristics (Note 3)</b>						
Gate Threshold Voltage	$V_{GS(th)}$	$V_{DS}=V_{GS}, I_D=-250\mu A$	-0.45	-0.7	-1	V
Drain-Source On-State Resistance	$R_{DS(on)}$	$V_{GS}=-4.5V, I_D=-4A$	-	36	45	m $\Omega$
		$V_{GS}=-2.5V, I_D=-2.5A$	-	45	60	m $\Omega$
Forward Transconductance	$g_{FS}$	$V_{DS}=-5V, I_D=-3.5A$	-	10	-	S
<b>Dynamic Characteristics (Note 4)</b>						
Input Capacitance	$C_{iss}$	$V_{DS}=-10V, V_{GS}=0V,$ $F=1.0MHz$	-	840	-	pF
Output Capacitance	$C_{oss}$		-	138	-	pF
Reverse Transfer Capacitance (Note 4)	$C_{rss}$		-	128	-	pF
<b>Switching Characteristics</b>						
Turn-on Delay Time	$t_{d(on)}$	$V_{DS}=-10V, R_L=1.2\Omega,$ $V_{GS}=-4.5V, R_G=3\Omega$	-	11	-	nS
Turn-on Rise Time	$t_r$		-	10	-	nS
Turn-Off Delay Time	$t_{d(off)}$		-	60	-	nS
Turn-Off Fall Time	$t_f$		-	10	-	nS
Total Gate Charge	$Q_g$	$V_{DS}=-10V, I_D=-4.1A,$ $V_{GS}=-4.5V$	-	7.5	-	nC
Gate-Source Charge	$Q_{gs}$		-	1.1	-	nC
Gate-Drain Charge	$Q_{gd}$		-	2.4	-	nC
<b>Drain-Source Diode Characteristics</b>						
Diode Forward Voltage (Note 3)	$V_{SD}$	$V_{GS}=0V, I_S=-1A$	-	-	-1.2	V
Diode Forward Current (Note 2)	$I_S$		-	-	-1.6	A

**Notes:**

1. Repetitive Rating: Pulse width limited by maximum junction temperature.
2. Surface Mounted on FR4 Board,  $t \leq 10$  sec.
3. Pulse Test: Pulse Width  $\leq 300\mu s$ , Duty Cycle  $\leq 2\%$ .
4. Guaranteed by design, not subject to product.



**Typical Electrical and Thermal Characteristics**

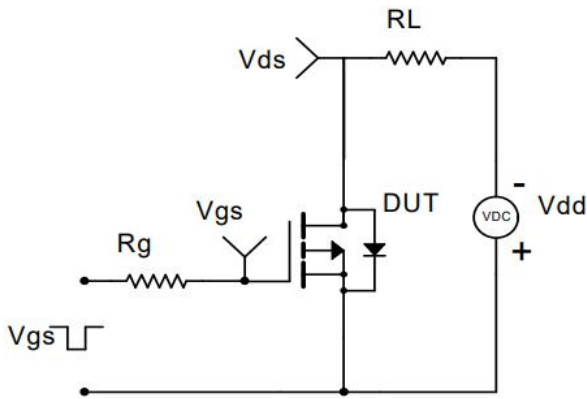

**Figure 1 Switching Test Circuit**

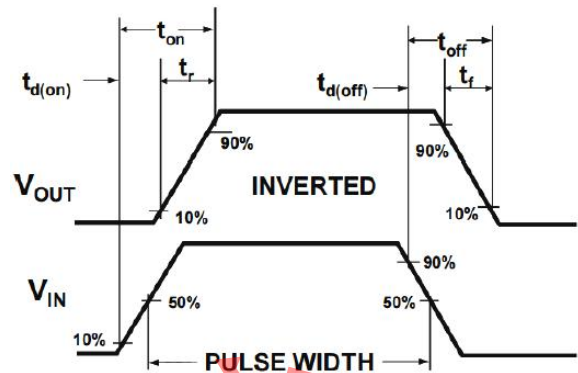

**Figure 2 Switching Waveform**

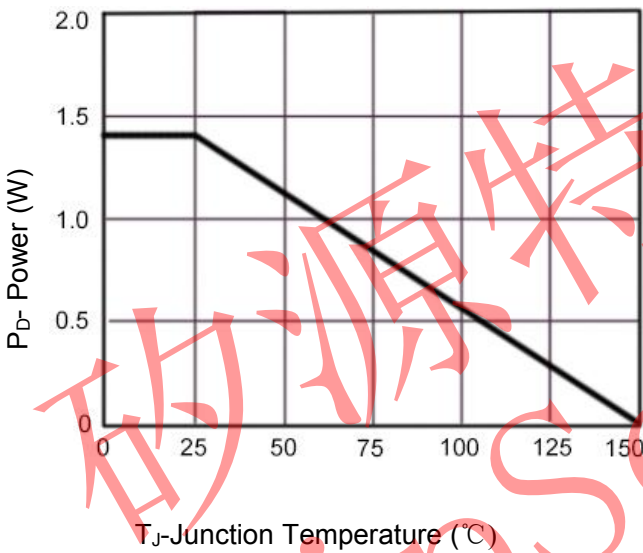

**Figure 3 Power De-rating**

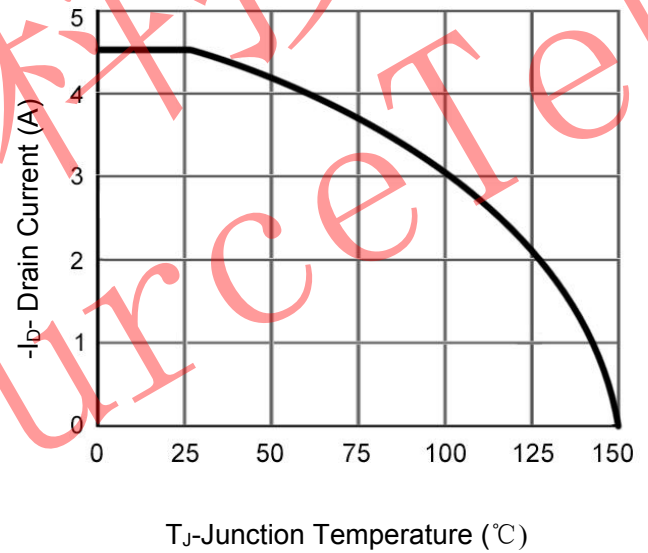

**Figure 4 Drain Current**

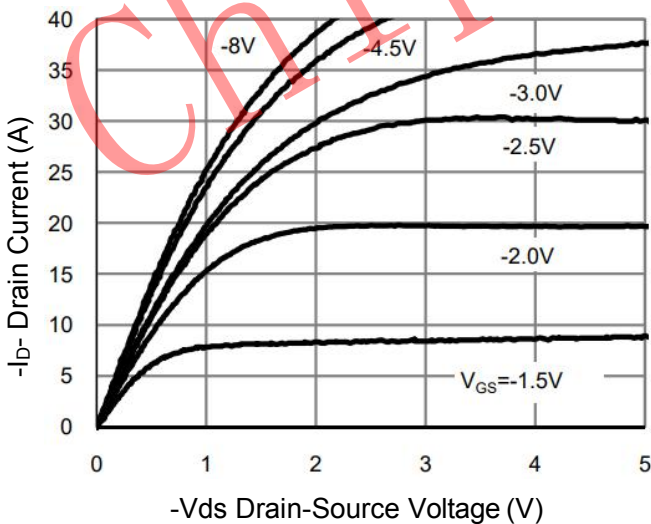

**Figure 5 Output Characteristics**

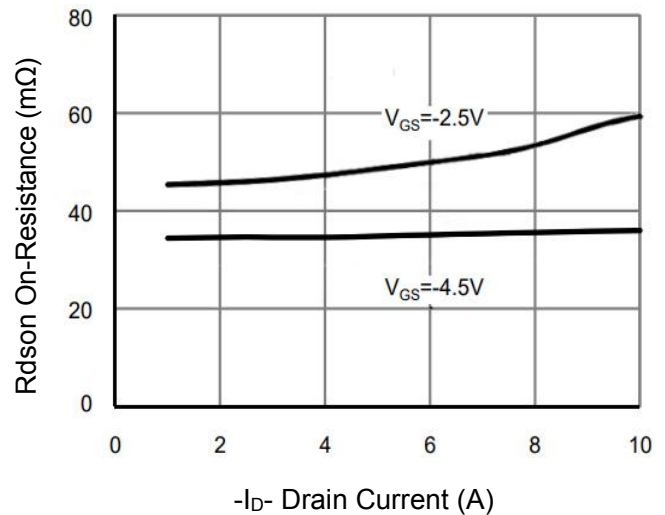

**Figure 6 Rdson vs Drain Current**

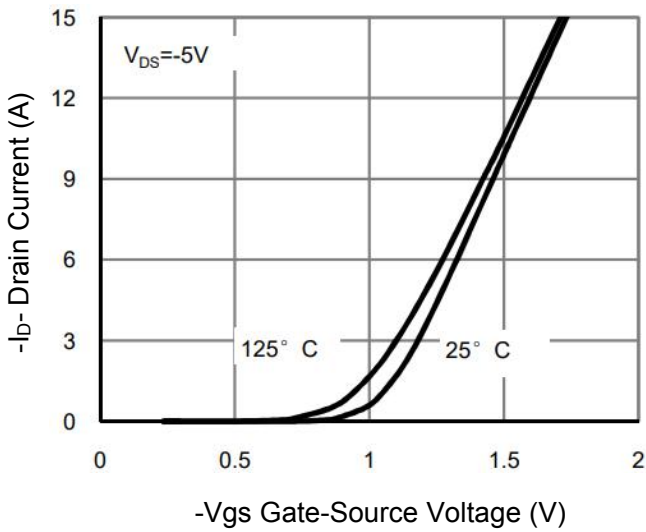

Figure 7 Transfer Characteristics

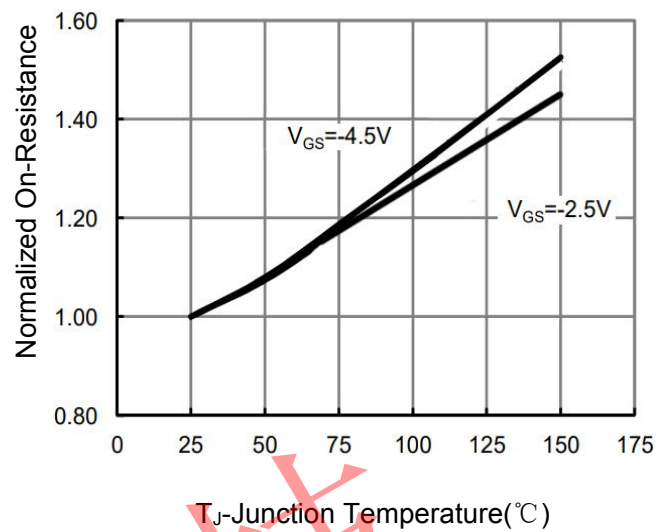

Figure 8 R<sub>dson</sub> vs Junction Temperature

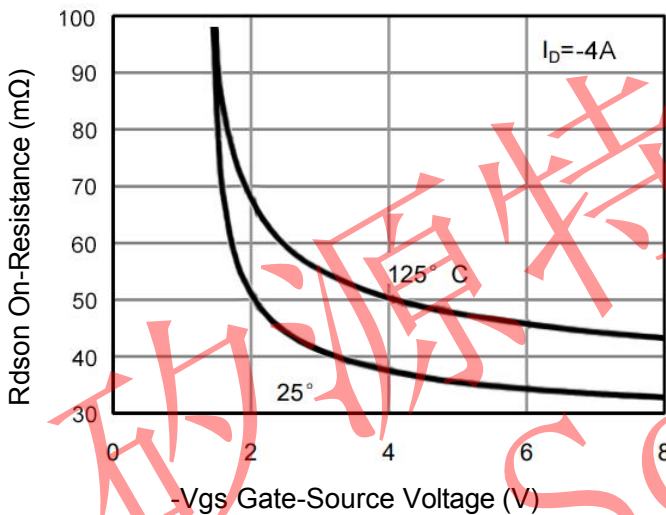

Figure 9 R<sub>dson</sub> vs V<sub>GS</sub>

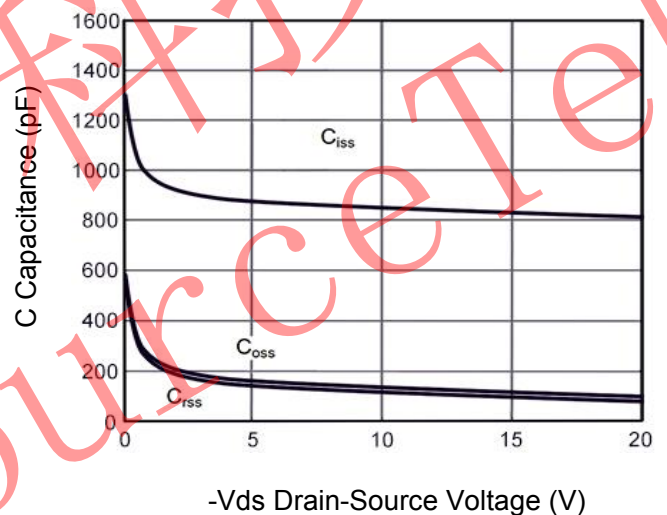

Figure 10 Capacitance vs V<sub>DS</sub>

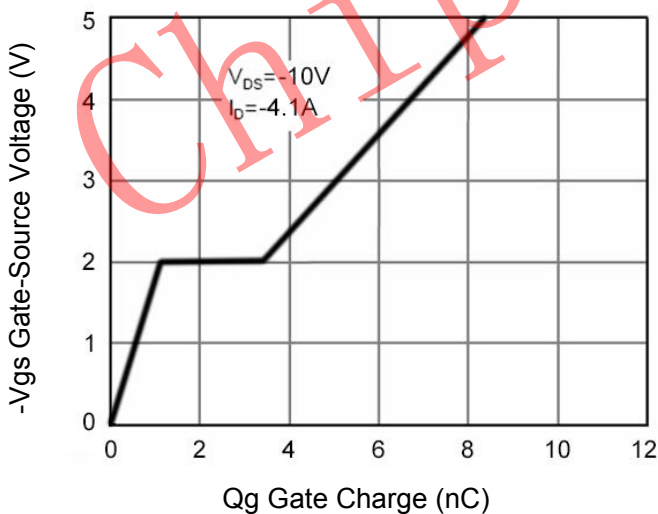

Figure 11 Gate Charge

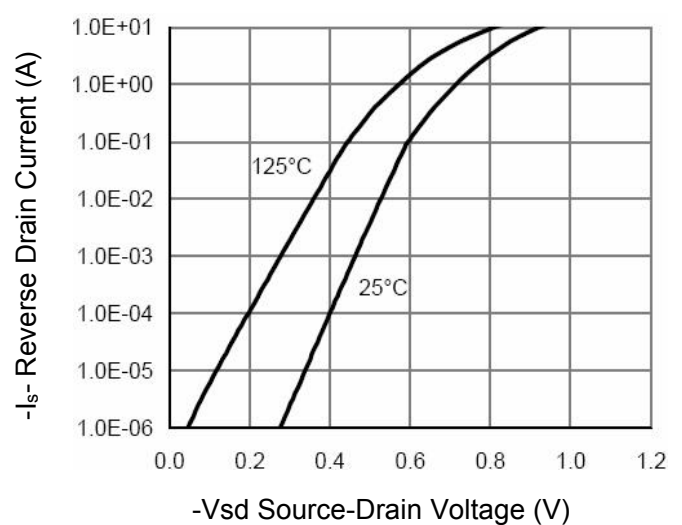

Figure 12 Source- Drain Diode Forward

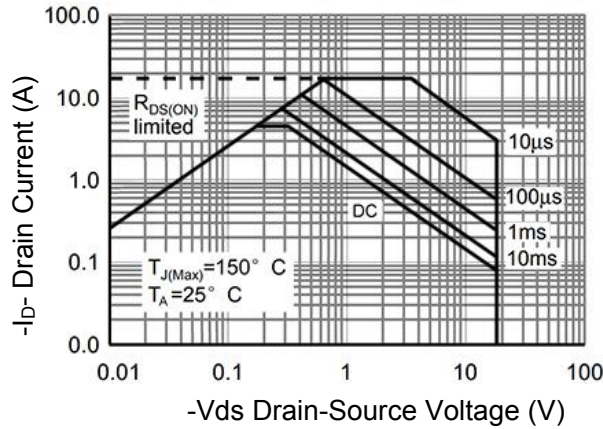

Figure 13 Safe Operation Area

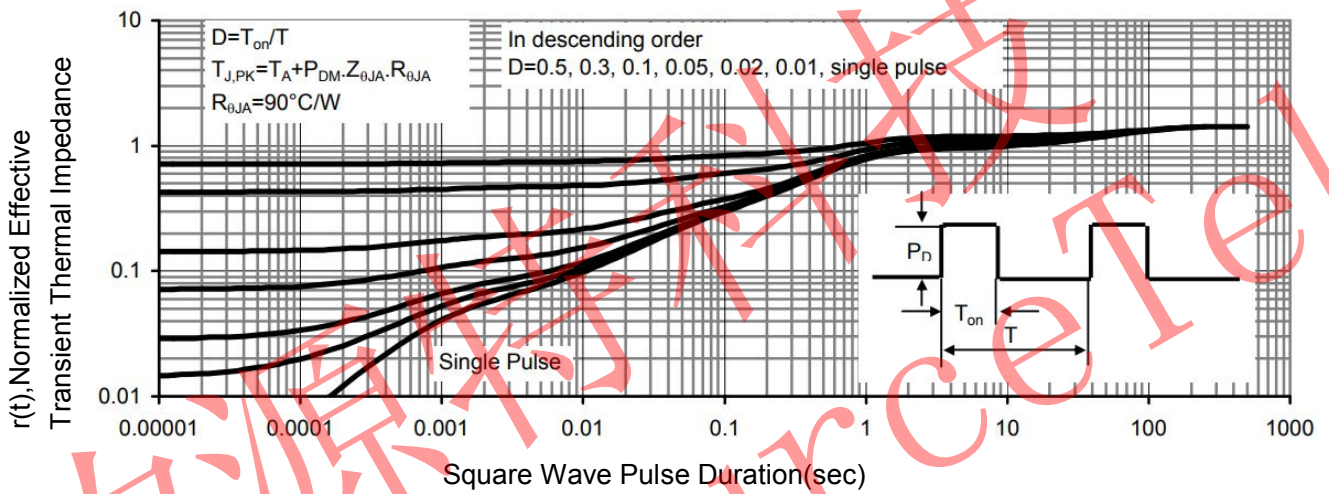
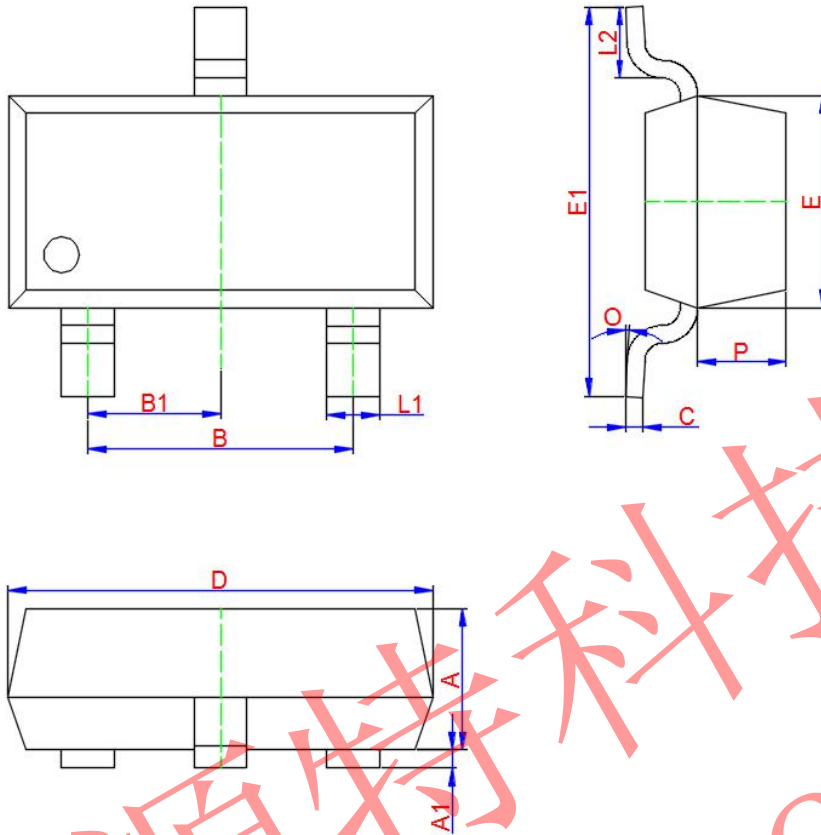

Figure 14 Normalized Maximum Transient Thermal Impedance



**SOT-23 Package Information**



Symbol	Dimensions In Millimeters		
	Min.	Typ.	Max.
A	0.900	1.000	1.100
A1	0.000	0.050	0.100
L1	0.300	0.400	0.500
C	0.100	0.110	0.120
D	2.800	2.900	3.000
E	1.250	1.300	1.350
E1	2.250	2.400	2.550
B	1.800	1.900	2.000
B1	0.950 TYP.		
L2	0.200	0.350	0.450
P	0.550	0.575	0.600
O	0°	4°	8°