



## P-Channel Enhancement Mode Power MOSFET

### Description

The PE4953 uses advanced trench technology to provide excellent  $R_{DS(ON)}$  and low gate charge. It can be used in a wide variety of applications.

### General Features

- $V_{DS} = -30V$ ,  $I_D = -5.3A$

$$R_{DS(ON)} < 49m\Omega @ V_{GS} = -10V$$

$$R_{DS(ON)} < 85m\Omega @ V_{GS} = -4.5V$$

- High Power and current handing capability
- Lead free product is acquired
- Surface Mount Package

### Application

- PWM applications
- Load switch
- Power management

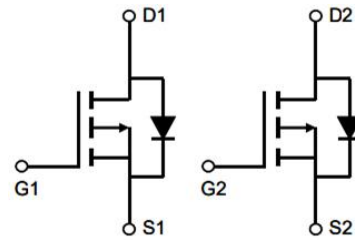

Schematic diagram

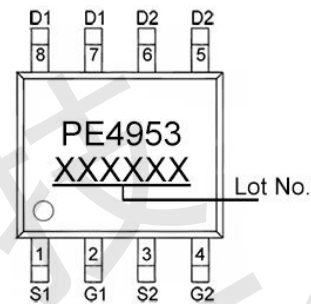

Marking and pin assignment

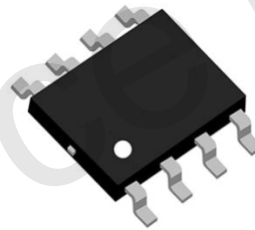

SOP-8

### Absolute Maximum Ratings (TA=25°C unless otherwise noted)

Parameter	Symbol	Rating	Unit
Drain-Source Voltage	$V_{DS}$	-30	V
Gate-Source Voltage	$V_{GS}$	$\pm 20$	V
Drain Current-Continuous	$I_D$	-5.3	A
Pulsed Drain Current (Note 1)	$I_{DM}$	-20	A
Maximum Power Dissipation	$P_D$	2.6	W
Operating Junction and Storage Temperature Range	$T_J, T_{STG}$	-55 To 150	°C

### Thermal Characteristic

Thermal Resistance, Junction-to-Ambient (Note 2)	$R_{\theta JA}$	62.5	°C/W
--	-----------------	------	------



**Electrical Characteristics (TA=25°C unless otherwise noted)**

Parameter	Symbol	Condition	Min	Typ	Max	Unit
<b>Off Characteristics</b>						
Drain-Source Breakdown Voltage	$BV_{DSS}$	$V_{GS}=0V, I_D=-250\mu A$	-30	-	-	V
Zero Gate Voltage Drain Current	$I_{DSS}$	$V_{DS}=-30V, V_{GS}=0V$	-	-	1	$\mu A$
Gate-Body Leakage Current	$I_{GSS}$	$V_{GS}=\pm 20V, V_{DS}=0V$	-	-	$\pm 100$	nA
<b>On Characteristics (Note 3)</b>						
Gate Threshold Voltage	$V_{GS(th)}$	$V_{DS}=V_{GS}, I_D=-250\mu A$	-1	-1.5	-3	V
Drain-Source On-State Resistance	$R_{DS(on)}$	$V_{GS}=-10V, I_D=-5.3A$	-	35	49	m $\Omega$
		$V_{GS}=-4.5V, I_D=-4.2A$	-	50	85	m $\Omega$
Forward Transconductance	$g_{FS}$	$V_{DS}=-10V, I_D=-4.1A$	5.5	-	-	S
<b>Dynamic Characteristics (Note 4)</b>						
Input Capacitance	$C_{iss}$	$V_{DS}=-15V, V_{GS}=0V,$ $F=1.0MHz$	-	510	-	pF
Output Capacitance	$C_{oss}$		-	85	-	pF
Reverse Transfer Capacitance (Note 4)	$C_{rss}$		-	65	-	pF
<b>Switching Characteristics</b>						
Turn-on Delay Time	$t_{d(on)}$	$V_{DS}=-15V, R_L=3.6\Omega,$ $V_{GS}=-10V, R_G=3\Omega$	-	9	-	nS
Turn-on Rise Time	$t_r$		-	5	-	nS
Turn-Off Delay Time	$t_{d(off)}$		-	28	-	nS
Turn-Off Fall Time	$t_f$		-	13.5	-	nS
Total Gate Charge	$Q_g$	$V_{DS}=-15V, I_D=-4A,$ $V_{GS}=-10V$	-	14	-	nC
Gate-Source Charge	$Q_{gs}$		-	2.2	-	nC
Gate-Drain Charge	$Q_{gd}$		-	3	-	nC
<b>Drain-Source Diode Characteristics</b>						
Diode Forward Voltage (Note 3)	$V_{SD}$	$V_{GS}=0V, I_S=-1A$	-	-	-1.2	V

**Notes:**

1. Repetitive Rating: Pulse width limited by maximum junction temperature.
2. Surface Mounted on FR4 Board,  $t \leq 10$  sec.
3. Pulse Test: Pulse Width  $\leq 300\mu s$ , Duty Cycle  $\leq 2\%$ .
4. Guaranteed by design, not subject to product.



Typical Electrical and Thermal Characteristics

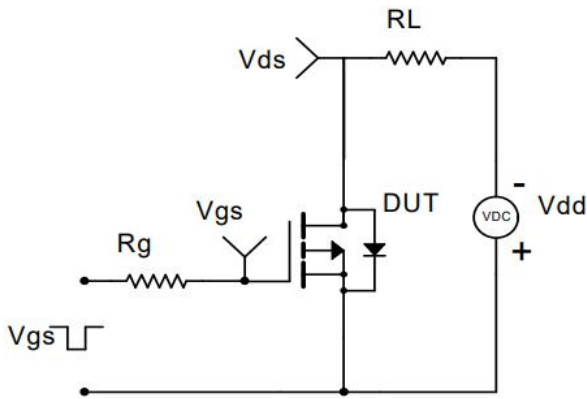

Figure 1 Switching Test Circuit

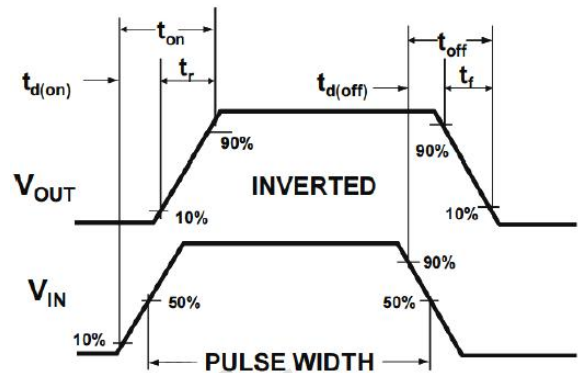

Figure 2 Switching Waveform

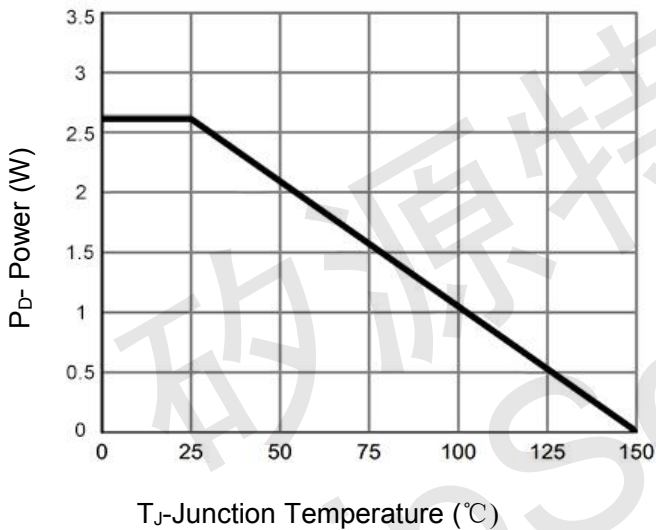

Figure 3 Power De-rating

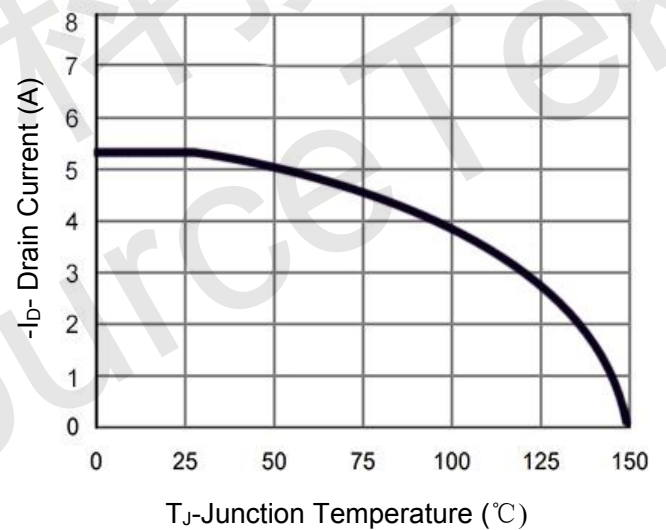

Figure 4 Drain Current

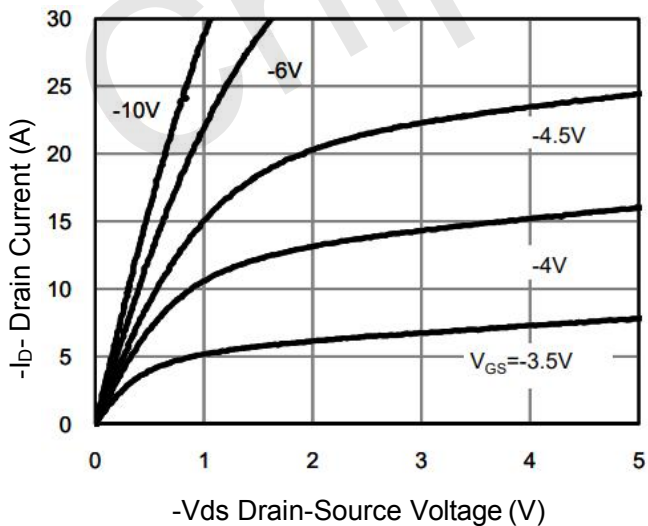

Figure 5 Output Characteristics

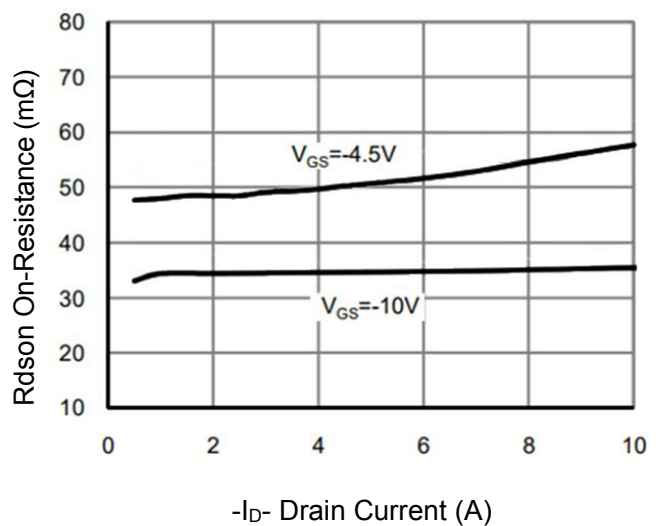

Figure 6 Rdson vs Drain Current

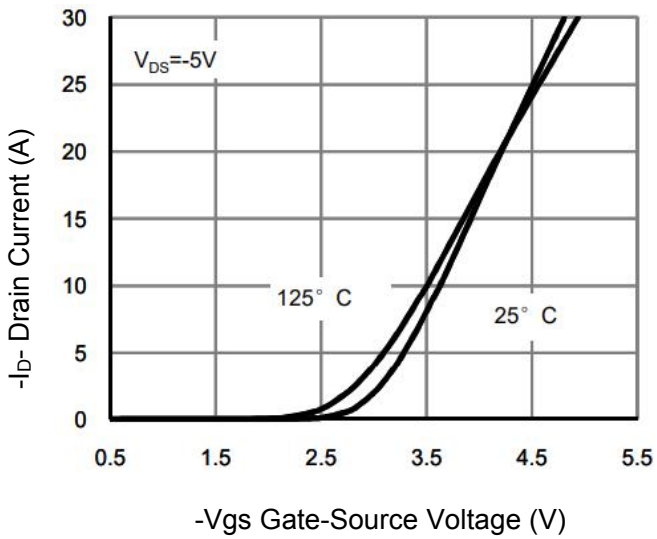

Figure 7 Transfer Characteristics

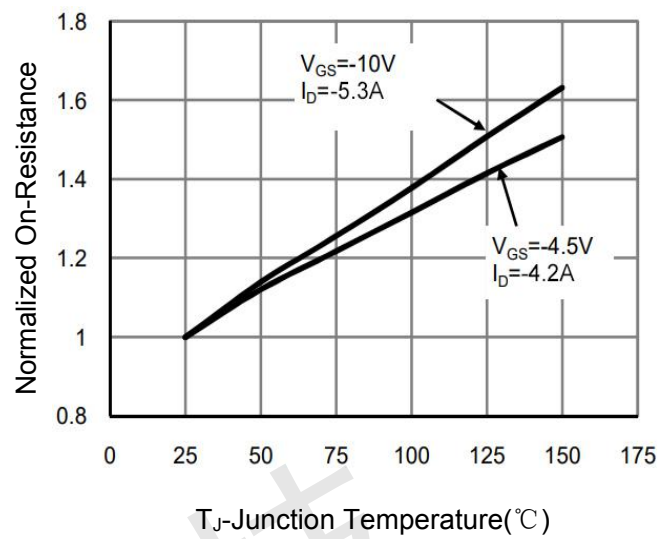

Figure 8 Rdson vs Junction Temperature

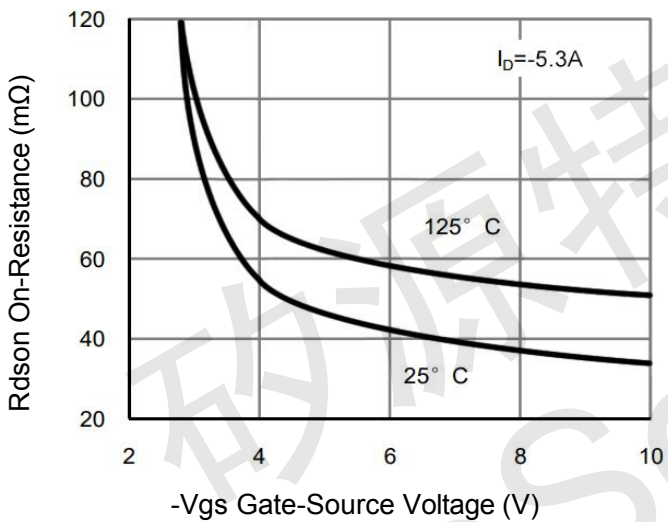

Figure 9 Rdson vs Vgs

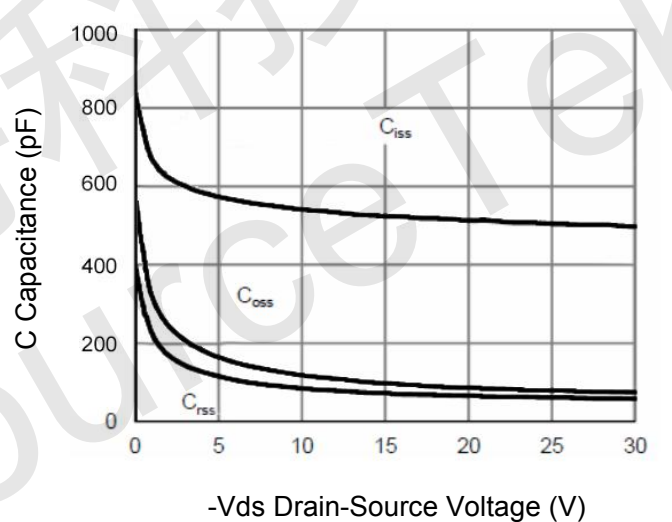

Figure 10 Capacitance vs Vds

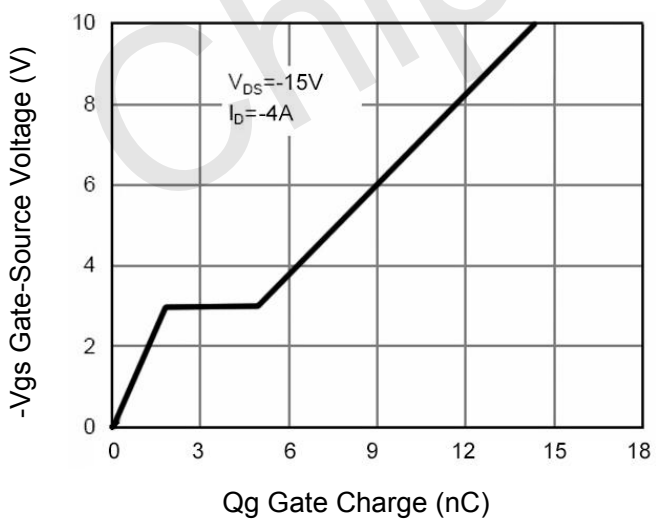

Figure 11 Gate Charge

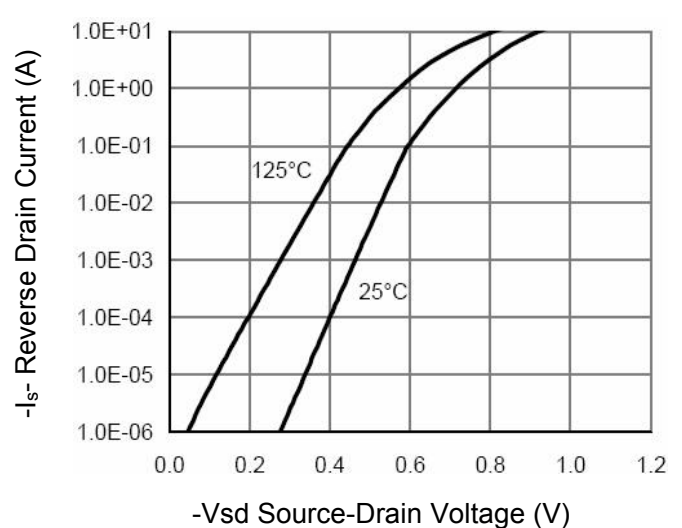

Figure 12 Source- Drain Diode Forward

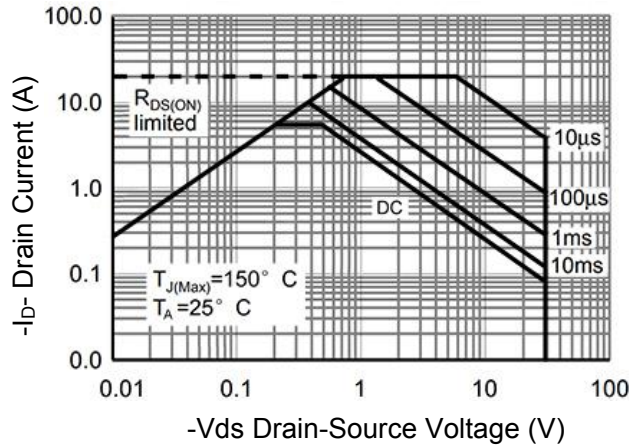

Figure 13 Safe Operation Area

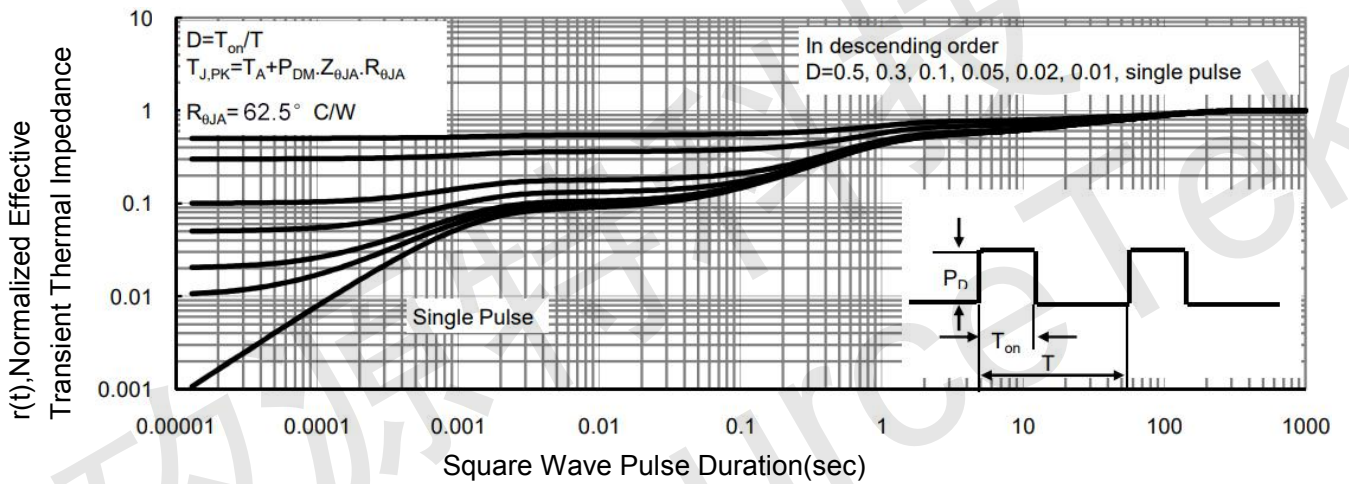
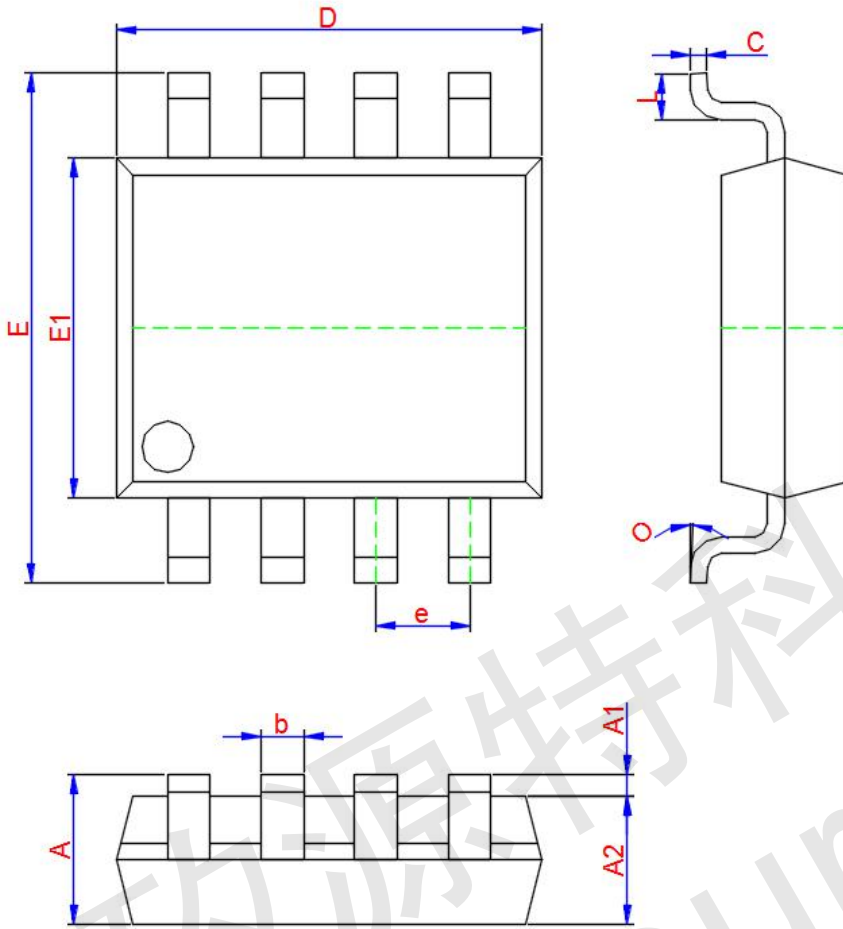

Figure 14 Normalized Maximum Transient Thermal Impedance



## SOP-8 Package Information



Symbol	Dimensions In Millimeters		
	Min.	Typ.	Max.
A	1.350	1.550	1.750
A1	0.100	0.175	0.250
A2	1.350	1.450	1.550
b	0.330	0.420	0.510
c	0.170	0.210	0.250
D	4.700	4.900	5.100
e	1.270 TYP.		
E	5.800	6.000	6.200
E1	3.750	3.900	4.050
L	0.400	0.835	1.270
O	0°	4°	8°