



AP4580 Full-bridge of MOSFET

Features

- | | |
|--|---|
| N-Channel | P-Channel |
| • $BV_{DSS} = 20V$ | • $BV_{DSS} = -20V$ |
| • $R_{DS(on)} (@V_{GS} = 4.5V) < 72m\Omega$ | • $R_{DS(on)} (@V_{GS} = -4.5V) < 146m\Omega$ |
| • $R_{DS(on)} (@V_{GS} = 2.5V) < 90m\Omega$ | • $R_{DS(on)} (@V_{GS} = -2.5V) < 220m\Omega$ |
| • Advanced Trench Technology | |
| • Excellent $R_{DS(on)}$ and Low Gate Charge | |
| • Lead free product is acquired | |

Application

- Load Switch
- PWM Application
- Power management

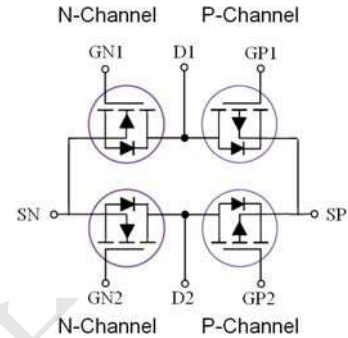

Package



Absolute Maximum Ratings ($T_A = 25^\circ C$ unless otherwise noted)

Parameter	Symbol	Maximum		Units
		N-Channel	P-Channel	
Drain-Source Voltage	V_{DS}	20	-20	V
Gate-Source Voltage	V_{GS}	± 10	± 10	V
Drain Current ($T_A=25^\circ C, t<10s, V_{GS}=10V$)	I_D	2.0	-1.8	A
Drain Current ($T_A=75^\circ C, t<10s, V_{GS}=10V$)		1.5	-1.3	A
Pulsed Drain Current ^a	I_{DM}	12	-10	A
Power Dissipation ^b ($T_A=25^\circ C$)	P_D	1.4	1.4	W
Power Dissipation ^b ($T_A=75^\circ C$)		1.0	0.9	W
Junction and Storage Temperature Range	T_J, T_{STG}	-55 ~ +150	-55 ~ +150	$^\circ C$

Thermal Characteristics

Parameter	Symbol	Maximum		Units
		P-Channel	N-Channel	
Junction-to-Ambient ^a ($t \leq 10s$)	$R_{\theta JA}$	100	100	$^\circ C/W$
Junction-to-Ambient ^{a,d} (Steady-State)		130	130	$^\circ C/W$
Junction-to-Lead (Steady-State)	$R_{\theta JL}$	90	90	$^\circ C/W$



N-Channel Electrical Characteristics ($T_A = 25^\circ\text{C}$ unless otherwise noted)

Symbol	Parameter	Conditions	Min	Typ	Max	Units	
Off Characteristics							
BV_{DSS}	Drain-Source Breakdown Voltage	$V_{GS} = 0V, I_D = 250\mu A$	20			V	
I_{DSS}	Zero Gate Voltage Drain Current	$V_{DS} = 20V, V_{GS} = 0V$			1	μA	
I_{GSS}	Gate-Body Leakage Current	$V_{GS} = \pm 10V, V_{DS} = 0V$			± 100	nA	
On Characteristics							
$V_{GS(th)}$	Gate Threshold Voltage	$V_{DS} = V_{GS}, I_D = 250\mu A$	0.45	0.7	1.0	V	
$R_{DS(ON)}$	Drain-Source On-State Resistance	$V_{GS} = 2.5V, I_D = 1.0A$		70	90	$m\Omega$	
		$V_{GS} = 4.5V, I_D = 2.0A$		60	72	$m\Omega$	
g_{FS}	Forward Transconductance	$V_{DS} = 5V, I_D = 1.5A$		20		S	
Drain-Source Diode Characteristics							
V_{SD}	Diode Forward Voltage	$V_{GS} = 0V, I_S = 1.0A$			1.2	V	
I_S	Maximum Body-Diode Continuous Current				2.0	A	
Dynamic Characteristics							
C_{iss}	Input Capacitance	$V_{DS} = 10V, V_{GS} = 0V$ $f = 1.0MHz$		240		pF	
C_{oss}	Output Capacitance				45		pF
C_{rss}	Reverse Transfer Capacitance				23		pF
Switching Characteristics							
Q_g	Total Gate Charge	$V_{DS} = 10V, I_D = 2.0A$ $V_{GS} = 6V$		2.7		nC	
Q_{gs}	Gate-Source Charge				0.5		nC
Q_{gd}	Gate-Drain Charge				0.4		nC
$t_{D(ON)}$	Turn-On Delay Time	$V_{DD} = 10V, I_D = 1A$ $V_{GS} = 6V$ $R_{GEN} = 6\text{ ohm}$		2.3		ns	
t_r	Turn-On Rise Time				3.2		ns
$t_{D(OFF)}$	Turn-Off Delay Time				20		ns
t_f	Turn-Off Fall Time				3		ns

Notes:

1. Repetitive Rating: Pulse width limited by maximum junction temperature.
2. Surface Mounted on FR4 Board, $t \leq 10$ sec.
3. Pulse Test: Pulse Width $\leq 300\mu s$, Duty Cycle $\leq 2\%$.
4. Guaranteed by design, not subject to production



AP4580 Full-bridge of MOSFET

Typical Electrical and Thermal Characteristics

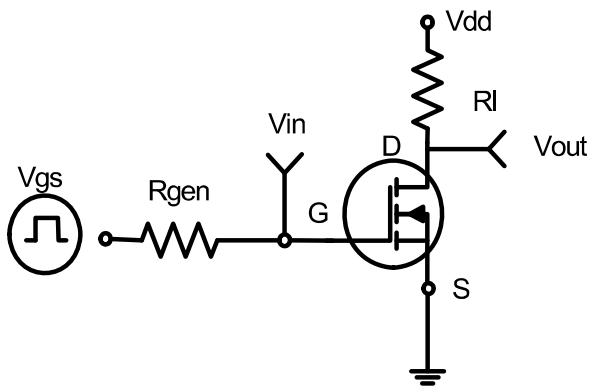

Figure 1: Switching Test Circuit

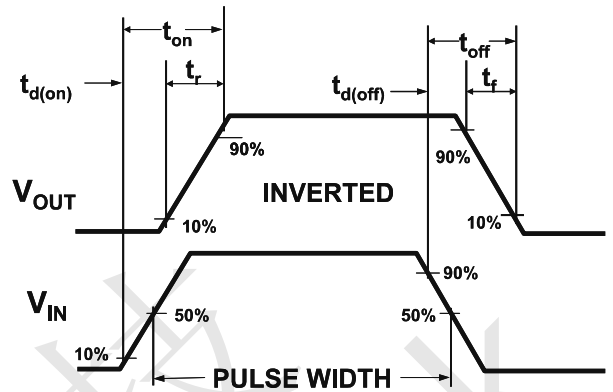

Figure 2: Switching Waveforms

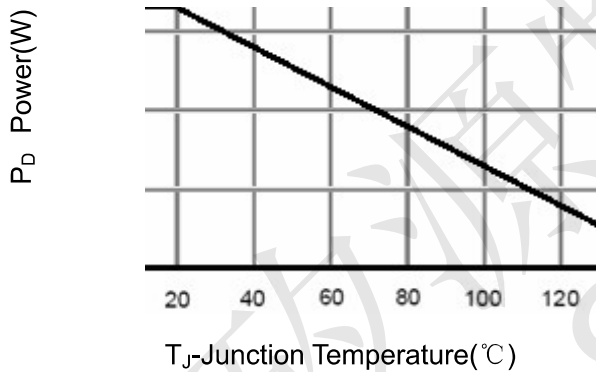

Figure 3 Power Dissipation

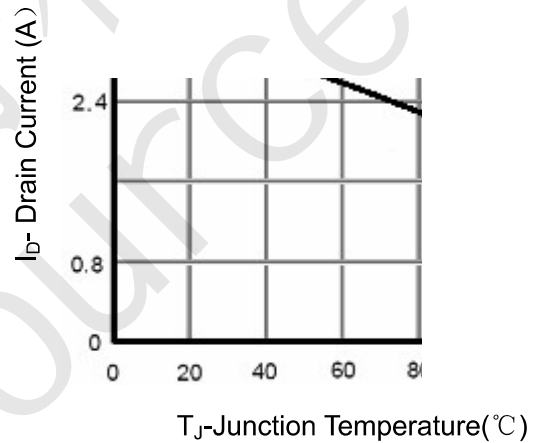

Figure 4 Drain Current

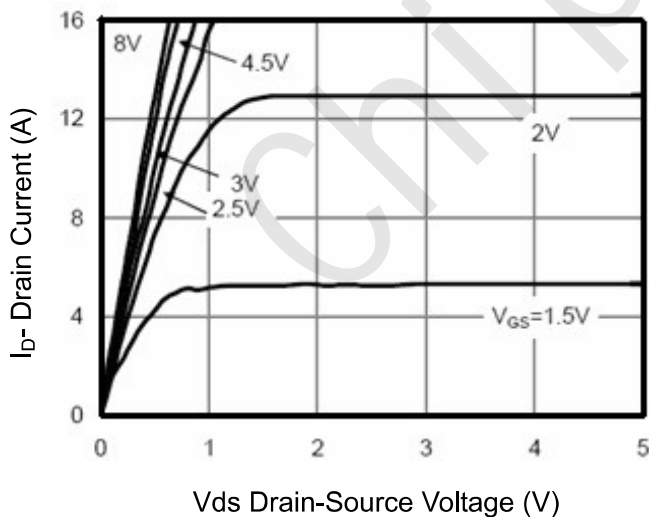

Figure 5 Output Characteristics

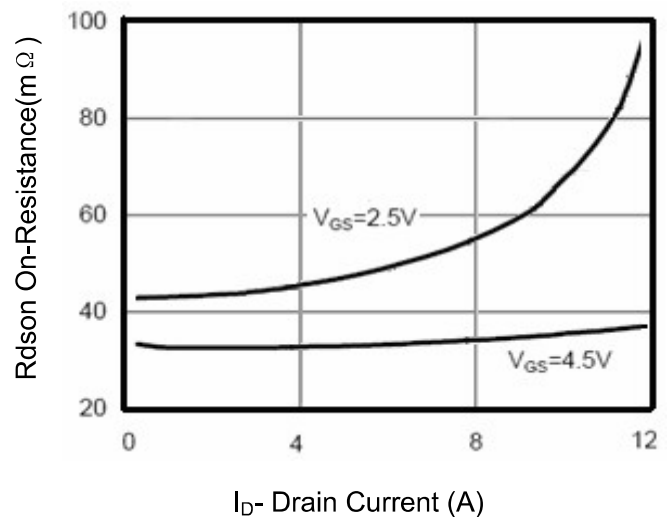
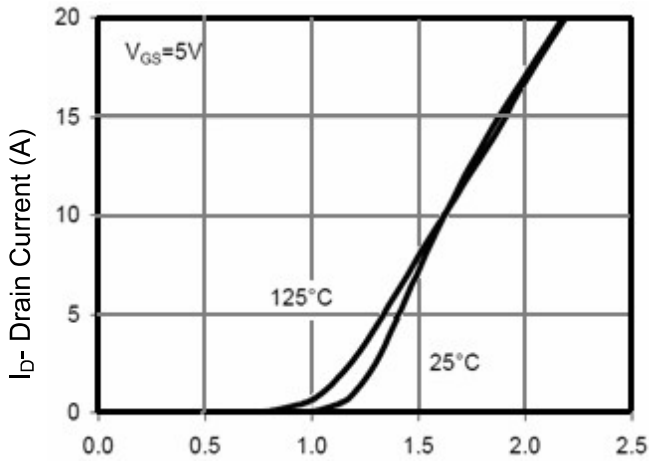

Figure 6 Drain-Source On-Resistance



AP4580 Full-bridge of MOSFET



Vgs Gate-Source Voltage (V)
Figure 7 Transfer Characteristics

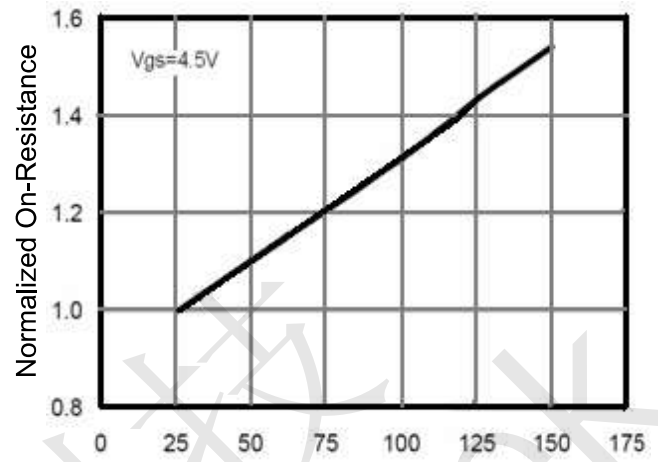

Tj-Junction Temperature(°C)
Figure 8 Drain-Source On-Resistance

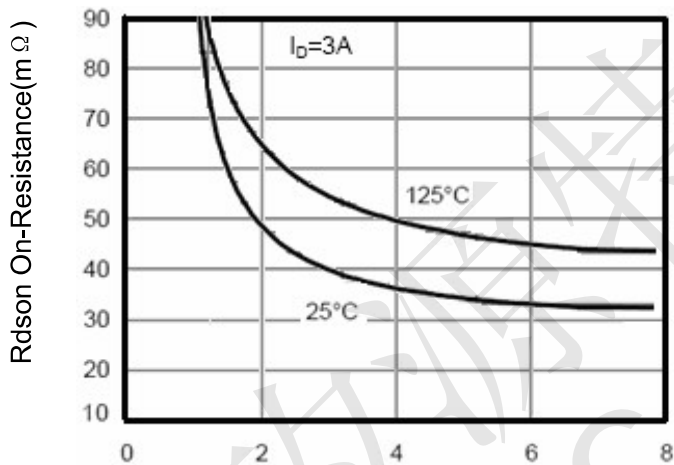

Vgs Gate-Source Voltage (V)
Figure 9 Rdson vs Vgs

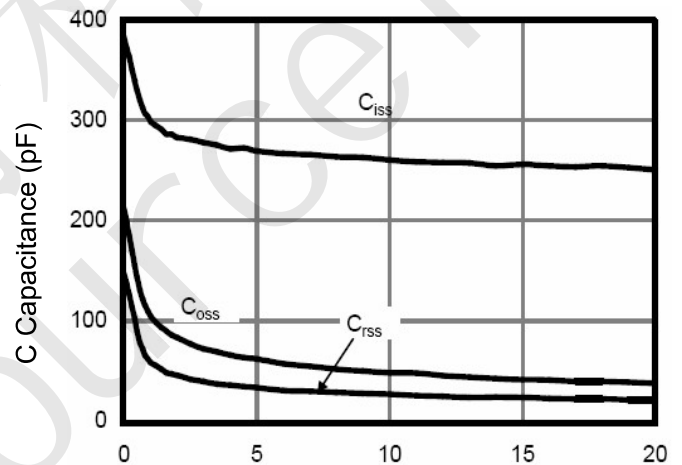

Vds Drain-Source Voltage (V)
Figure 10 Capacitance vs Vds

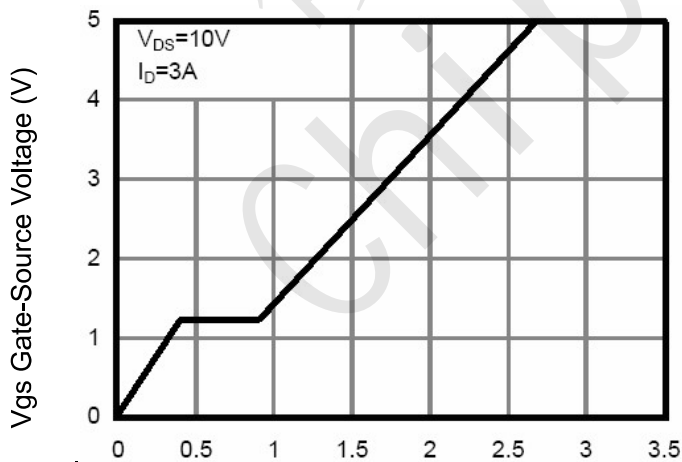

Qg Gate Charge (nC)
Figure 11 Gate Charge

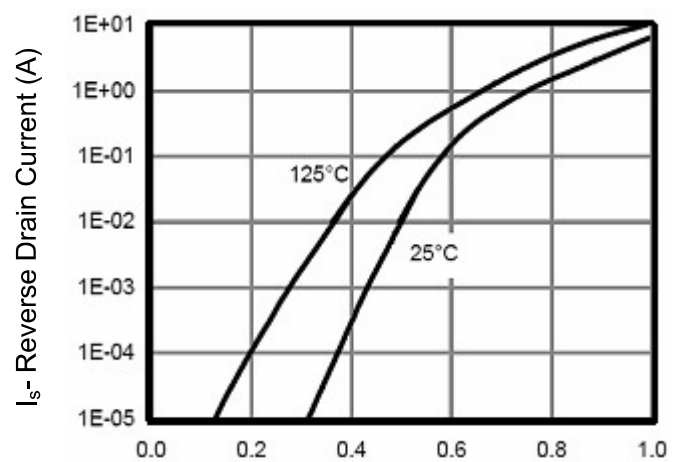

Vsd Source-Drain Voltage (V)
Figure 12 Source- Drain Diode Forward



AP4580 Full-bridge of MOSFET

P-Channel Electrical Characteristics ($T_A = 25^\circ\text{C}$ unless otherwise noted)						
Symbol	Parameter	Conditions	Min	Typ	Max	Units
Off Characteristics						
BV_{DSS}	Drain-Source Breakdown Voltage	$V_{GS} = 0V, I_D = -250\mu\text{A}$	-20			V
I_{DSS}	Zero Gate Voltage Drain Current	$V_{DS} = -20V, V_{GS} = 0V$			-1	μA
I_{GSS}	Gate-Body Leakage Current	$V_{GS} = \pm 10V, V_{DS} = 0V$			± 100	nA
On Characteristics						
$V_{GS(th)}$	Gate Threshold Voltage	$V_{DS} = V_{GS}, I_D = -250\mu\text{A}$	-0.45	0.7	-1.0	V
$R_{DS(ON)}$	Drain-Source On-State Resistance	$V_{GS} = -2.5V, I_D = -1.0\text{A}$		190	220	$\text{m}\Omega$
		$V_{GS} = -4.5V, I_D = -1.8\text{A}$		128	146	$\text{m}\Omega$
g_{FS}	Forward Transconductance	$V_{DS} = -5V, I_D = -1.0\text{A}$		15		S
Drain-Source Diode Characteristics						
V_{SD}	Diode Forward Voltage	$V_{GS} = 0V, I_S = -1.0\text{A}$			-1.2	V
I_S	Maximum Body-Diode Continuous Current				-1.8	A
Dynamic Characteristics						
C_{iss}	Input Capacitance	$V_{DS} = -10V, V_{GS} = 0V$ $f = 1.0\text{MHz}$		290		pF
C_{oss}	Output Capacitance			100		pF
C_{rss}	Reverse Transfer Capacitance			34		pF
Switching Characteristics						
Q_g	Total Gate Charge	$V_{DS} = -10V, I_D = -1.8\text{A}$ $V_{GS} = -6V$		3.0		nC
Q_{gs}	Gate-Source Charge			0.5		nC
Q_{gd}	Gate-Drain Charge			0.8		nC
$t_{D(ON)}$	Turn-On Delay Time	$V_{DD} = -10V, I_D = -1\text{A}$ $V_{GS} = -6V$ $R_{GEN} = 6\text{ohm}$		9.5		ns
t_r	Turn-On Rise Time			4.9		ns
$t_{D(OFF)}$	Turn-Off Delay Time			21.5		ns
t_f	Turn-Off Fall Time			10		ns

Notes:

1. Repetitive Rating: Pulse width limited by maximum junction temperature.
2. Surface Mounted on FR4 Board, $t \leq 10$ sec.
3. Pulse Test: Pulse Width $\leq 300\mu\text{s}$, Duty Cycle $\leq 2\%$.
4. Guaranteed by design, not subject to production



AP4580 Full-bridge of MOSFET

Typical Electrical and Thermal Characteristics

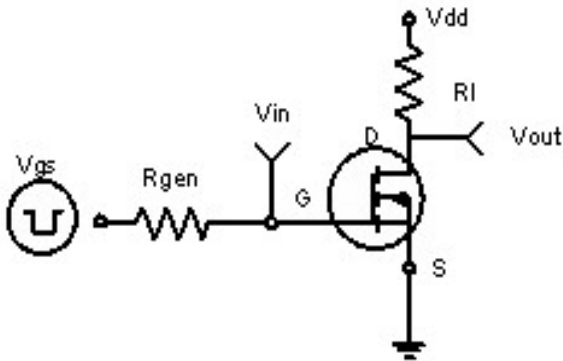

Figure 1: Switching Test Circuit

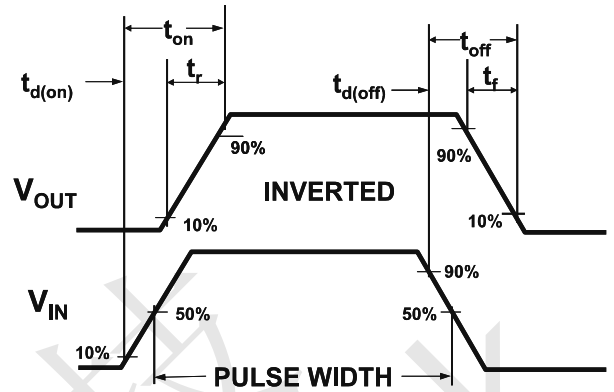

Figure 2: Switching Waveforms

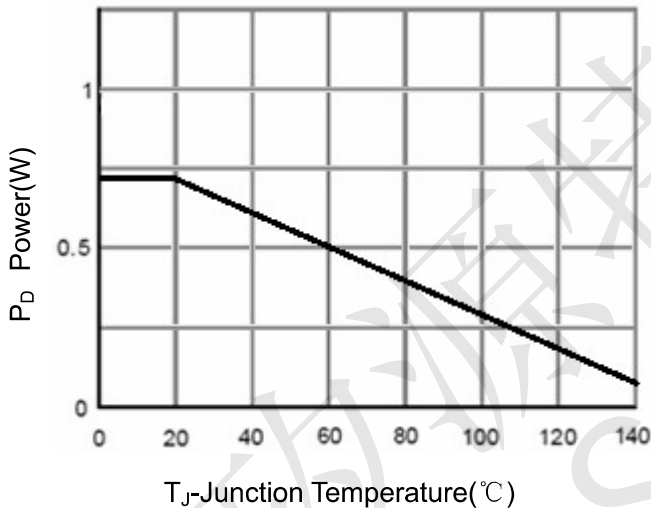

Figure 3 Power Dissipation

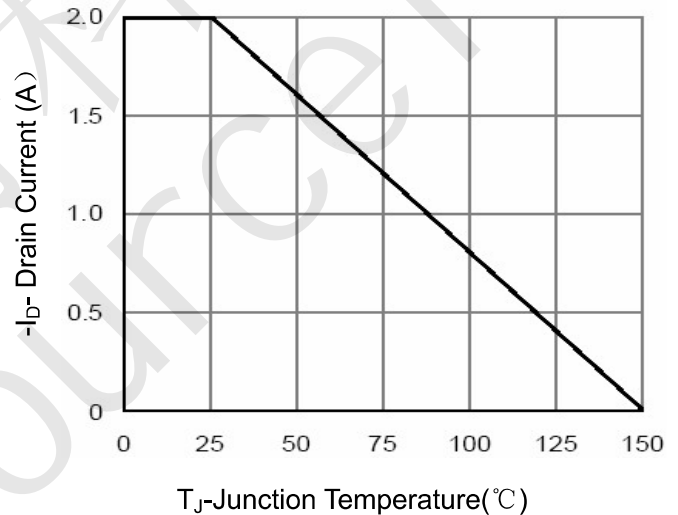

Figure 4 Drain Current

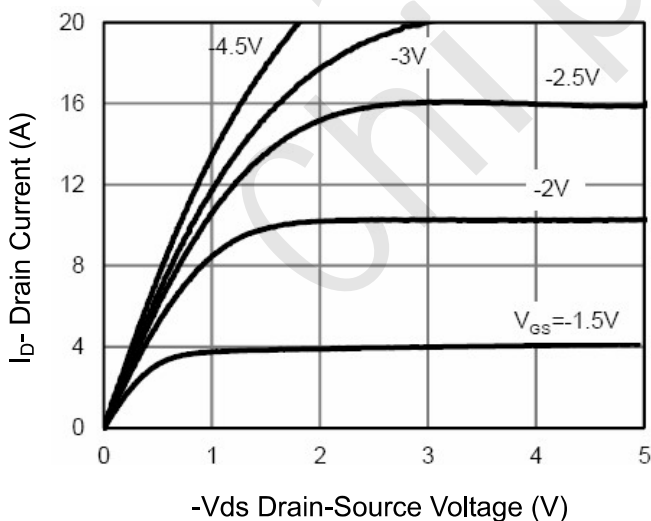

Figure 5 Output Characteristics

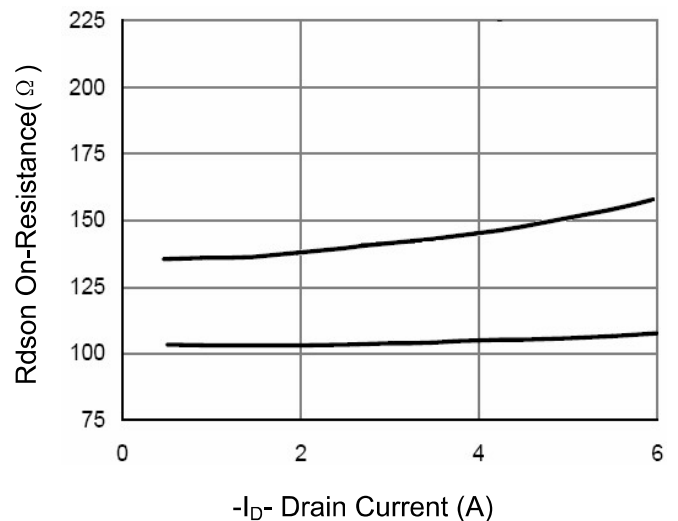

Figure 6 Drain-Source On-Resistance



AP4580 Full-bridge of MOSFET

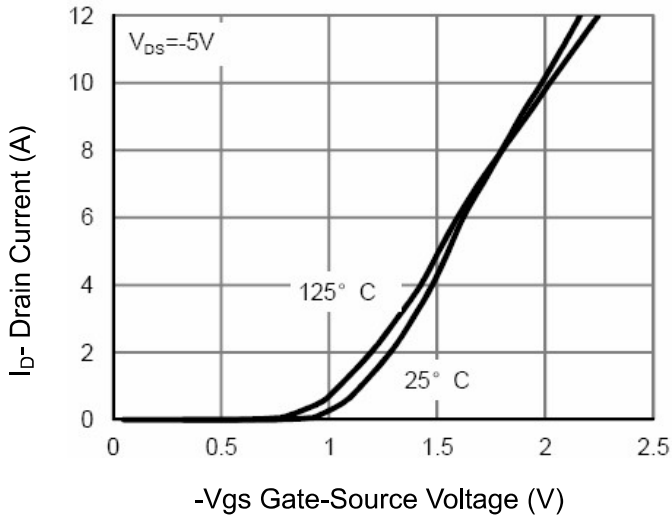

Figure 7 Transfer Characteristics

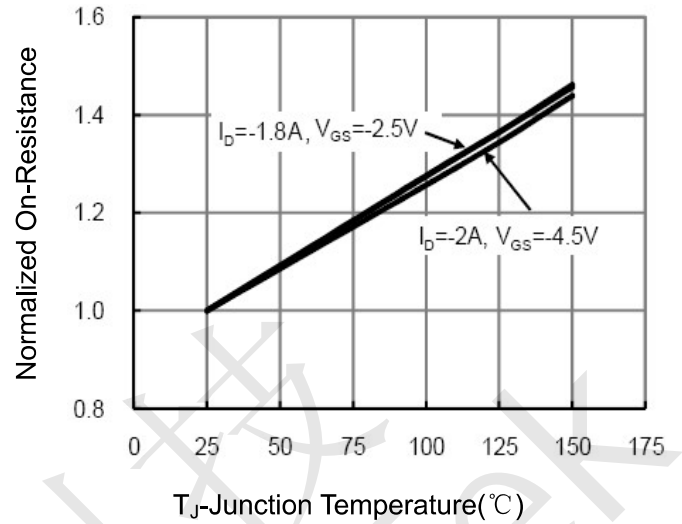

Figure 8 Drain-Source On-Resistance

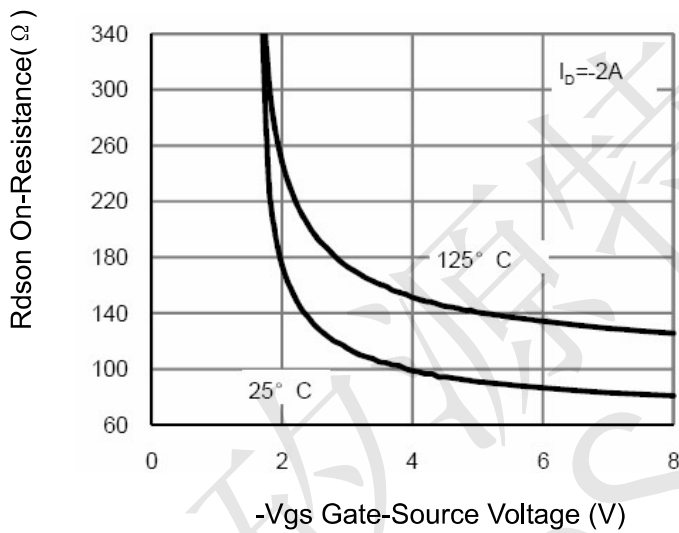

Figure 9 Rds(on) vs Vgs

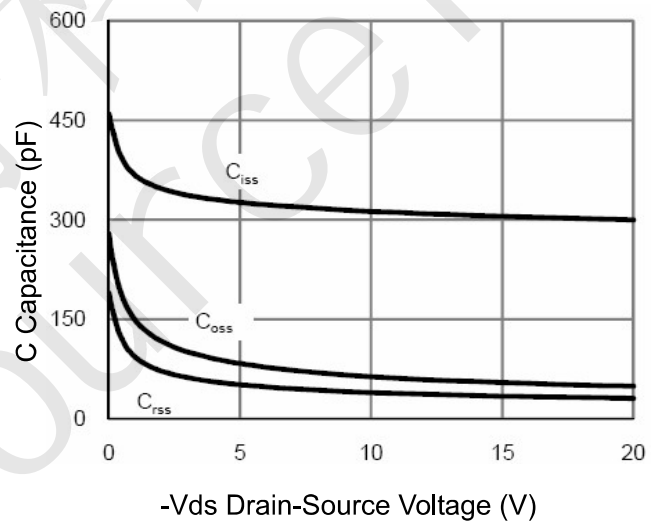

Figure 10 Capacitance vs Vds

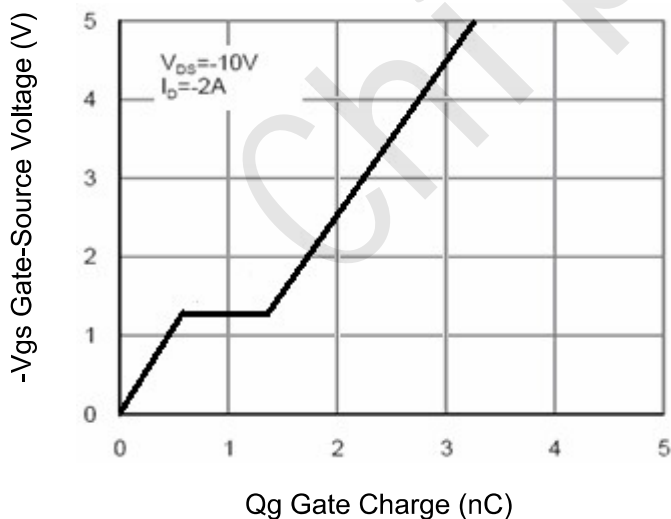

Figure 11 Gate Charge

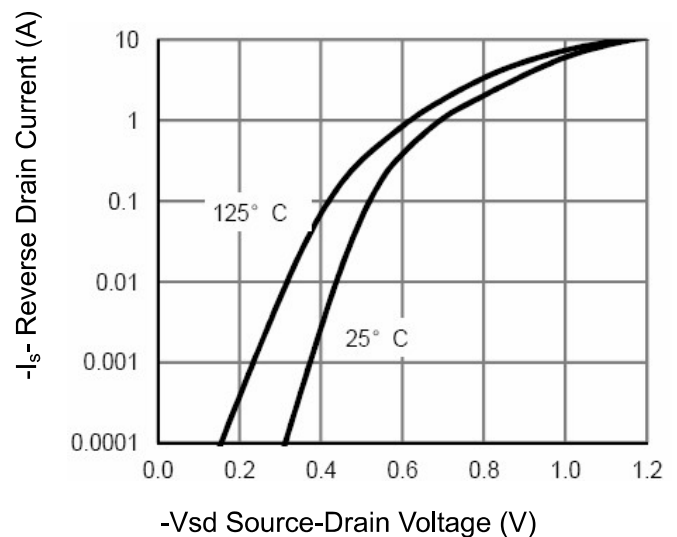

Figure 12 Source- Drain Diode Forward



AP4580 Full-bridge of MOSFET

SOT23-8L Package Outline

