



CST100N03 N-Ch 30V Fast Switching MOSFETs



- ★ Super Low Gate Charge
- ★ 100% EAS Guaranteed
- ★ Green Device Available
- ★ Excellent CdV/dt effect decline
- ★ Advanced high cell density Trench technology

CST100N03 Product Summary

BVDSS	RDSON	ID
30V	3.5mΩ	100A

CST100N03 Description

The CST100N03 is the high cell density trenched N-ch MOSFETs, which provide excellent RDSON and gate charge for most of the synchronous buck converter applications.

The CST100N03 meet the RoHS and Green Product requirement, 100% EAS guaranteed with full function reliability approved.

CST100N03 TO252 Pin Configuration

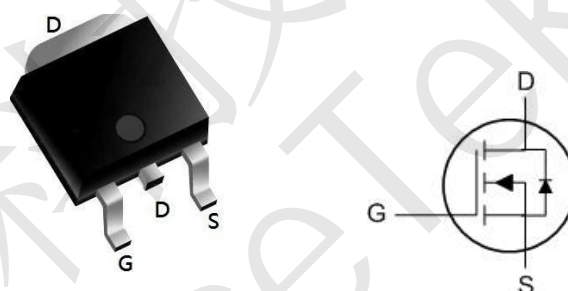

CST100N03 Absolute Maximum Ratings (T_C=25°C unless otherwise specified)

Symbol	Parameter	Max.	Units	
V _{DSS}	Drain-Source Voltage	30	V	
V _{GSS}	Gate-Source Voltage	±20	V	
I _D	Continuous Drain Current	T _C = 25°C	100	A
		T _C = 100°C	65	A
I _{DM}	Pulsed Drain Current ^{note1}	400	A	
E _{AS}	Single Pulsed Avalanche Energy ^{note2}	95	mJ	
P _D	Power Dissipation	80	W	
R _{θJC}	Thermal Resistance, Junction to Case	1.9	°C/W	
T _J , T _{STG}	Operating and Storage Temperature Range	-55 to +175	°C	



CST100N03 N-Ch 30V Fast Switching MOSFETs

CST100N03 Electrical Characteristics ($T_J=25^\circ\text{C}$ unless otherwise specified)

Symbol	Parameter	Test Condition	Min.	Typ.	Max.	Units
$V_{(BR)DSS}$	Drain-Source Breakdown Voltage	$V_{GS}=0V, I_D=250\mu A$	30	-	-	V
I_{DSS}	Zero Gate Voltage Drain Current	$V_{DS}=30V, V_{GS}=0V,$	-	-	1.0	μA
I_{GSS}	Gate to Body Leakage Current	$V_{DS}=0V, V_{GS}=\pm 20V$	-	-	± 100	nA
$V_{GS(th)}$	Gate Threshold Voltage	$V_{DS}=V_{GS}, I_D=250\mu A$	1.0	1.5	2.5	V
$R_{DS(on)}$	Static Drain-Source on-Resistance <small>note3</small>	$V_{GS}=10V, I_D=30A$	-	3.5	4.7	m Ω
		$V_{GS}=4.5V, I_D=20A$	-	5.5	10	
C_{iss}	Input Capacitance	$V_{DS}=15V, V_{GS}=0V,$ $f=1.0MHz$	-	2100	-	pF
C_{oss}	Output Capacitance		-	326	-	pF
C_{rss}	Reverse Transfer Capacitance		-	282	-	pF
Q_g	Total Gate Charge		-	45	-	nC
Q_{gs}	Gate-Source Charge	$V_{DS}=15V, I_D=30A,$ $V_{GS}=10V$	-	3	-	nC
Q_{gd}	Gate-Drain("Miller") Charge		-	15	-	nC
$t_{d(on)}$	Turn-on Delay Time	$V_{DS}=15V,$ $I_D=30A, R_{GEN}=3\Omega,$ $V_{GS}=10V$	-	21	-	ns
t_r	Turn-on Rise Time		-	32	-	ns
$t_{d(off)}$	Turn-off Delay Time		-	59	-	ns
t_f	Turn-off Fall Time		-	34	-	ns
I_S	Maximum Continuous Drain to Source Diode Forward Current		-	-	50	A
I_{SM}	Maximum Pulsed Drain to Source Diode Forward Current		-	-	200	A
V_{SD}	Drain to Source Diode Forward Voltage	$V_{GS}=0V, I_S=30A$	-	-	1.2	V
t_{rr}	Body Diode Reverse Recovery Time	$I_F=20A, di/dt=100A/\mu s$	-	15	-	ns
Q_{rr}	Body Diode Reverse Recovery Charge		-	4	-	nC

Notes:1. Repetitive Rating: Pulse Width Limited by Maximum Junction Temperature

2. EAS condition: $T_J=25^\circ\text{C}, V_G=10V, R_G=25\Omega, L=0.5mH, I_{AS}=18.4A$

3. Pulse Test: Pulse Width $\leq 300\mu s$, Duty Cycle $\leq 0.5\%$



CST100N03 N-Ch 30V Fast Switching MOSFETs

1

Figure 1: Output Characteristics

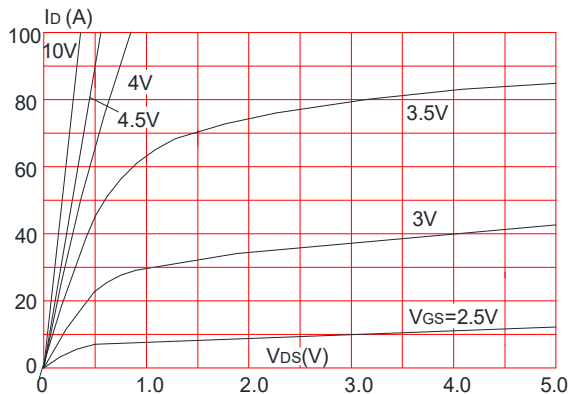

Figure 2: Typical Transfer Characteristics

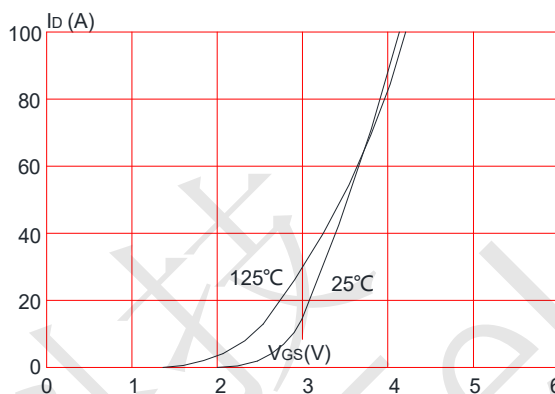

Figure 3: On-resistance vs. Drain Current

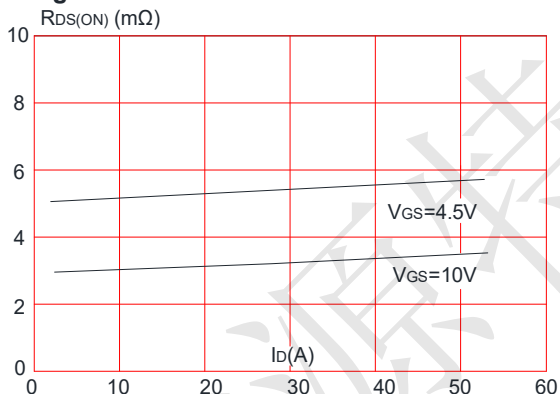

Figure 4: Body Diode Characteristics

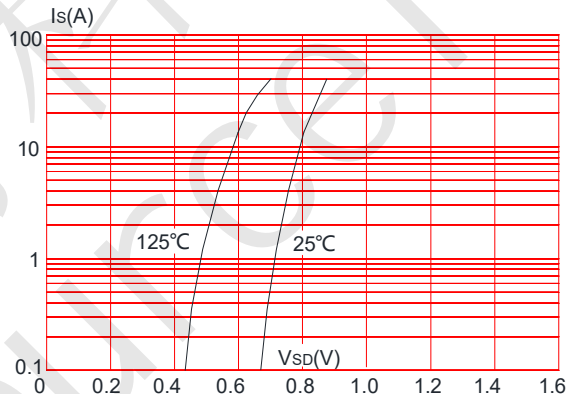

Figure 5: Gate Charge Characteristics

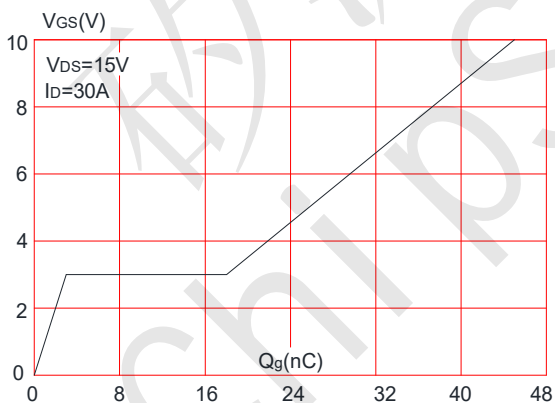
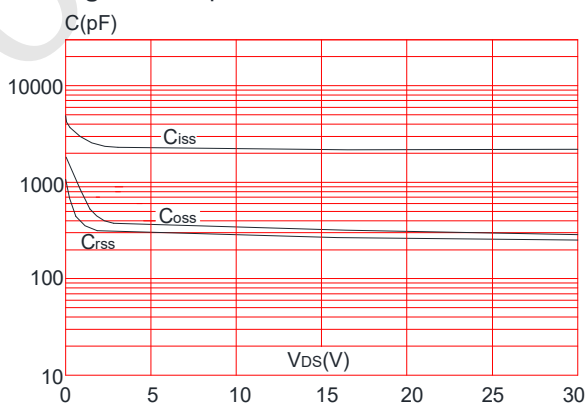

Figure 6: Capacitance Characteristics





CST100N03 N-Ch 30V Fast Switching MOSFETs

Figure 7: Normalized Breakdown Voltage vs. Junction Temperature

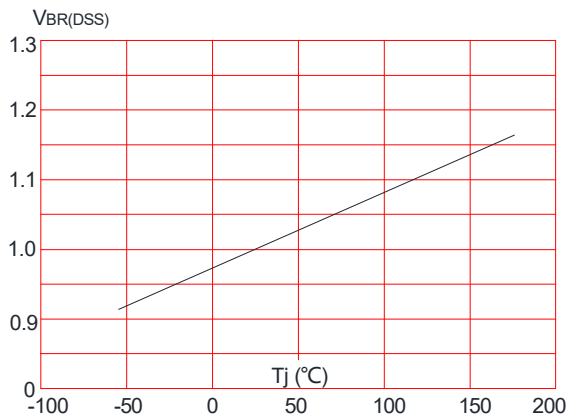

Figure 8: Normalized on Resistance vs. Junction Temperature

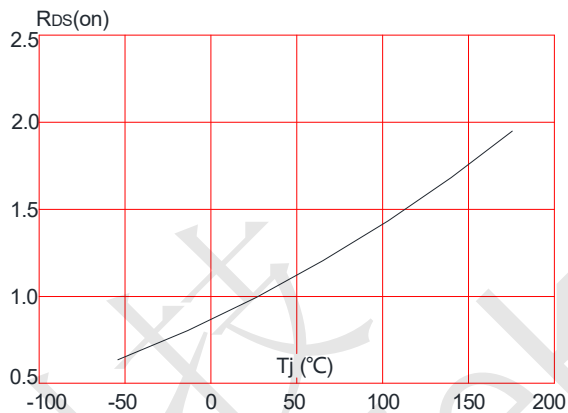

Figure 9: Maximum Safe Operating Area

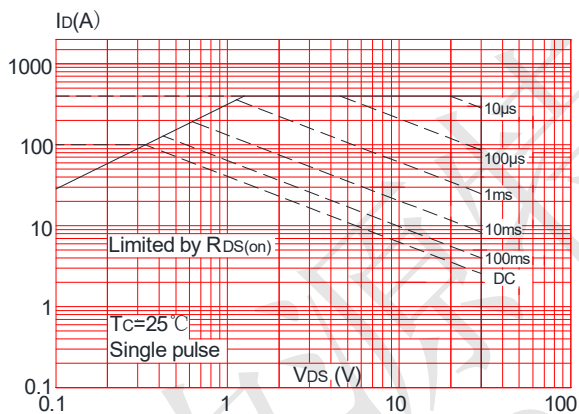

Figure 10: Maximum Continuous Drain Current vs. Case Temperature

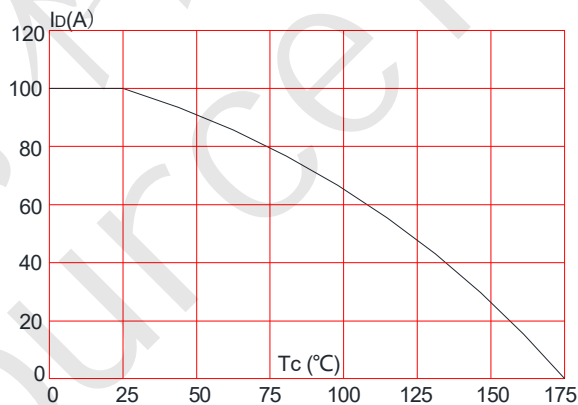
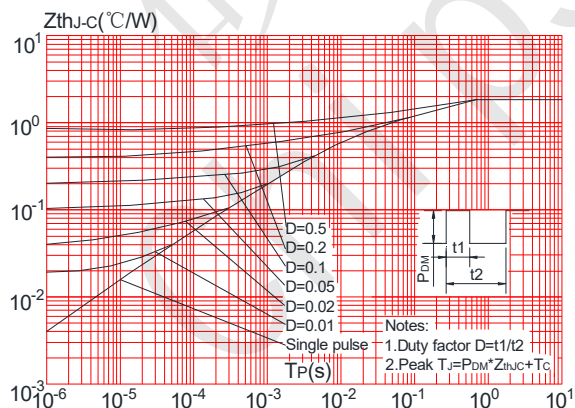

Figure.11: Maximum Effective Transient Thermal Impedance, Junction-to-Case





CST100N03 N-Ch 30V Fast Switching MOSFETs

CST100N03 Test Circuit

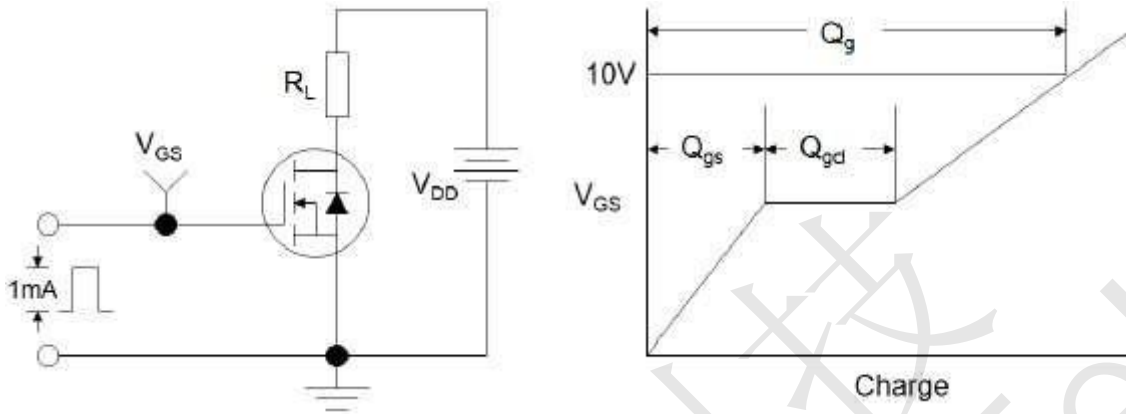

Figure1:Gate Charge Test Circuit & Waveform

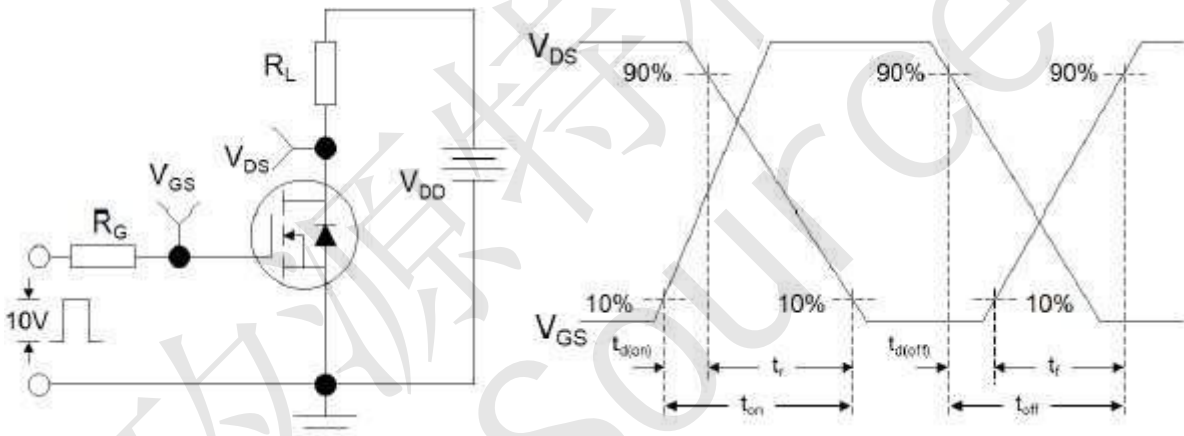

Figure 2: Resistive Switching Test Circuit & Waveforms

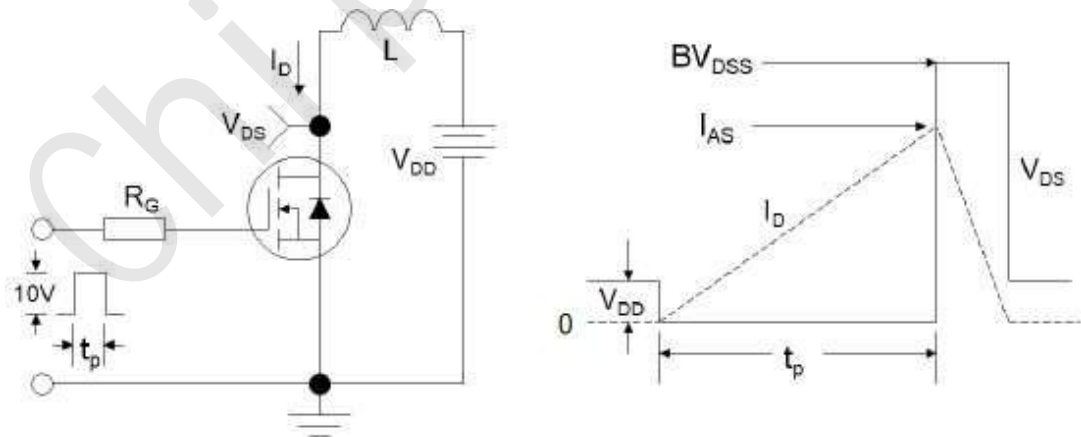
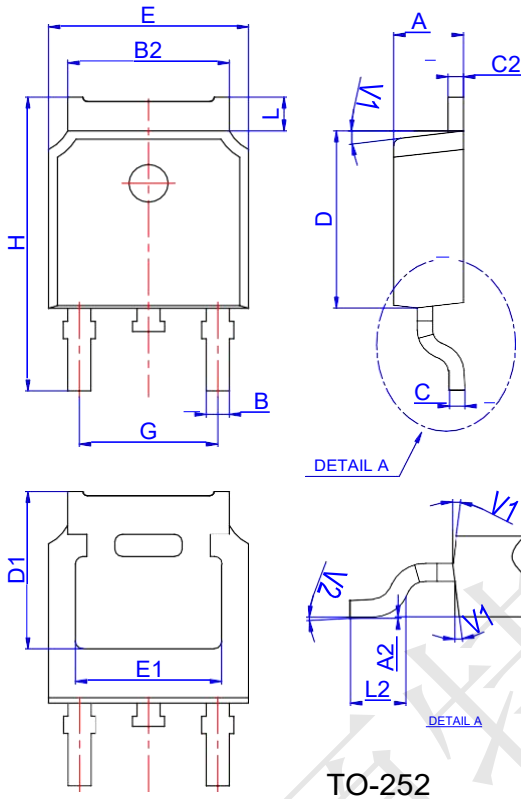

Figure 3:Unclamped Inductive Switching Test Circuit & Waveforms



CST100N03 N-Ch 30V Fast Switching MOSFETs

CST100N03 Package Mechanical Data TO 252 4R



Ref.	Dimensions					
	Millimeters			Inches		
	Min.	Typ.	Max.	Min.	Typ.	Max.
A	2.10		2.50	0.083		0.098
A2	0		0.10	0		0.004
B	0.66		0.86	0.026		0.034
B2	5.18		5.48	0.202		0.216
C	0.40		0.60	0.016		0.024
C2	0.44		0.58	0.017		0.023
D	5.90		6.30	0.232		0.248
D1	5.30REF			0.209REF		
E	6.40		6.80	0.252		0.268
E1	4.63			0.182		
G	4.47		4.67	0.176		0.184
H	9.50		10.70	0.374		0.421
L	1.09		1.21	0.043		0.048
L2	1.35		1.65	0.053		0.065
V1		7°			7°	
V2	0°		6°	0°		6°

CST100N03 Reel Specification-TO-252-4R

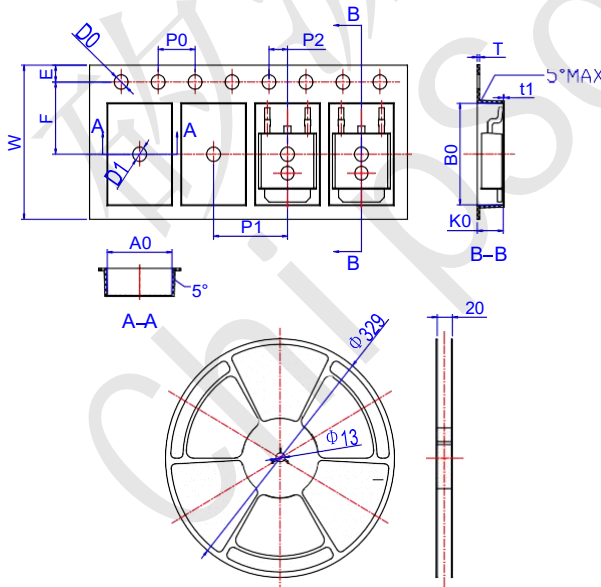

Ref.	Dimensions					
	Millimeters			Inches		
	Min.	Typ.	Max.	Min.	Typ.	Max.
W	15.90	16.00	16.10	0.626	0.630	0.634
E	1.65	1.75	1.85	0.065	0.069	0.073
F	7.40	7.50	7.60	0.291	0.295	0.299
D0	1.40	1.50	1.60	0.055	0.059	0.063
D1	1.40	1.50	1.60	0.055	0.059	0.063
P0	3.90	4.00	4.10	0.154	0.157	0.161
P1	7.90	8.00	8.10	0.311	0.315	0.319
P2	1.90	2.00	2.10	0.075	0.079	0.083
A0	6.85	6.90	7.00	0.270	0.271	0.276
B0	10.45	10.50	10.60	0.411	0.413	0.417
K0	2.68	2.78	2.88	0.105	0.109	0.113
T	0.24		0.27	0.009		0.011
t1	0.10			0.004		
10P0	39.80	40.00	40.20	1.567	1.575	1.583