



CST20N10 N-Ch 100V Fast Switching MOSFETs

- ★ Super Low Gate Charge
- ★ Green Device Available
- ★ Excellent Cdv/dt effect decline
- ★ Advanced high cell density Trench technology

CST20N10 Product Summary



BVDSS	RDSON	ID
100V	65mΩ	20A

CST20N10 Description

The CST20N10 is the highest performance trench N-ch MOSFETs with extreme high cell density, which provide excellent RDSON and gate charge for most of the synchronous buck converter applications .

The CST20N10 meet the RoHS and Green Product requirement, 100% EAS guaranteed with full function reliability approved.

CST20N10 TO252 Pin Configuration

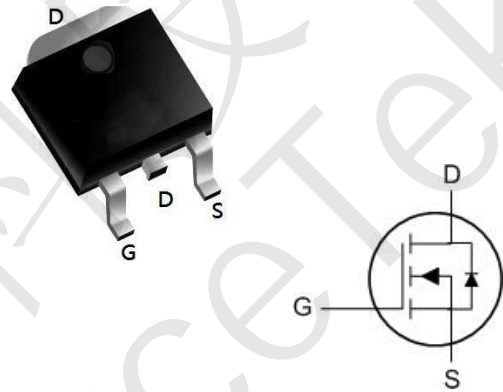

CST20N10 Absolute Maximum Ratings

Symbol	Parameter	Rating	Units
V _{DS}	Drain-Source Voltage	100	V
V _{GS}	Gate-Source Voltage	±20	V
I _D @T _C =25°C	Continuous Drain Current, V _{GS} @ 10V ¹	20	A
I _D @T _C =100°C	Continuous Drain Current, V _{GS} @ 10V ¹	12	A
I _{DM}	Pulsed Drain Current ²	80	A
EAS	Single Pulse Avalanche Energy ³	4.1	mJ
I _{AS}	Avalanche Current	10	A
P _D @T _C =25°C	Total Power Dissipation ³	41.7	W
T _{STG}	Storage Temperature Range	-55 to 150	°C
T _J	Operating Junction Temperature Range	-55 to 150	°C

CST20N10 Thermal Data

Symbol	Parameter	Typ.	Max.	Unit
R _{θJA}	Thermal Resistance Junction-ambient ¹	---	50	°C/W
R _{θJC}	Thermal Resistance Junction-Case ¹	---	3.0	°C/W



CST20N10 N-Ch 100V Fast Switching MOSFETs

CST20N10 Electrical Characteristics (T_J = 25°C, unless otherwise noted)

Parameter	Symbol	Test Conditions	Min.	Typ.	Max.	Unit	
Static Characteristics							
Drain-Source Breakdown Voltage	V _{(BR)DSS}	V _{GS} = 0V, I _D = 250μA	100	-	-	V	
Gate-body Leakage current	I _{GSS}	V _{DS} = 0V, V _{GS} = ±20V	-	-	±100	nA	
Zero Gate Voltage Drain Current	I _{DSS}	V _{DS} = 100V, V _{GS} = 0V	T _J = 25°C	-	-	1	μA
			T _J = 100°C	-	-	100	
Gate-Threshold Voltage	V _{GS(th)}	V _{DS} = V _{GS} , I _D = 250μA	1.2	-	2.5	V	
Drain-Source on-Resistance ⁴	R _{DS(on)}	V _{GS} = 10V, I _D = 5A	-	65	90	mΩ	
		V _{GS} = 4.5V, I _D = 3A	-	75	105		
Forward Transconductance ⁴	g _{fs}	V _{DS} = 5V, I _D = 5A	-	12	-	S	
Dynamic Characteristics⁵							
Input Capacitance	C _{iss}	V _{DS} = 15V, V _{GS} = 0V, f = 1MHz	-	1220	-	pF	
Output Capacitance	C _{oss}		-	53	-		
Reverse Transfer Capacitance	C _{rss}		-	42	-		
Gate Resistance	R _g	f = 1MHz	-	1.3	-	Ω	
Switching Characteristics⁵							
Total Gate Charge	Q _g	V _{GS} = 10V, V _{DS} = 50V, I _D = 5A	-	20.6	-	nC	
Gate-Source Charge	Q _{gs}		-	4	-		
Gate-Drain Charge	Q _{gd}		-	3.7	-		
Turn-On Delay Time	t _{d(on)}	V _{GS} = 10V, V _{DD} = 50V, R _G = 3Ω, I _D = 5A	-	4.7	-	ns	
Rise Time	t _r		-	21	-		
Turn-Off Delay Time	t _{d(off)}		-	20	-		
Fall Time	t _f		-	16	-		
Drain-Source Body Diode Characteristics							
Diode Forward Voltage ⁴	V _{SD}	I _S = 1A, V _{GS} = 0V	-	-	1.2	V	
Continuous Source Current	I _S	T _C = 25°C	-	-	20	A	

Notes:

1. Repetitive rating, pulse width limited by junction temperature T_{J(MAX)} = 150°C.
2. The data tested by pulsed, pulse width ≤ 300us, duty cycle ≤ 2%
3. The EAS data shows Max. rating. The test condition is V_{DD} = 25V, V_{GS} = 10V, L = 0.1mH, I_{AS} = 8A
4. The power dissipation is limited by 150°C junction temperature
5. The data is theoretically the same as I_D and I_{DM}, in real applications, should be limited by total power dissipation.



CST20N10 Typical Characteristics

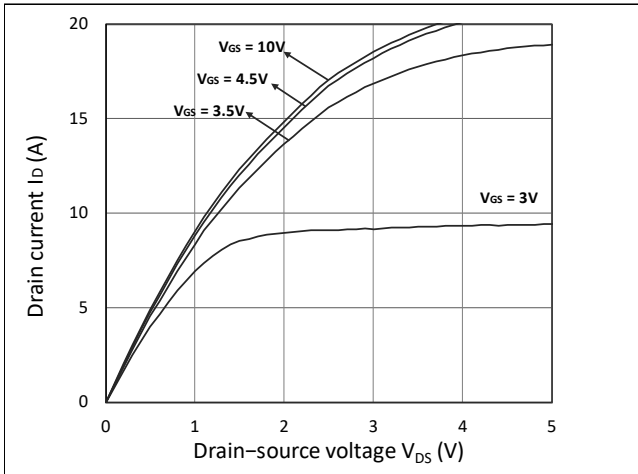

Figure 1. Output Characteristics

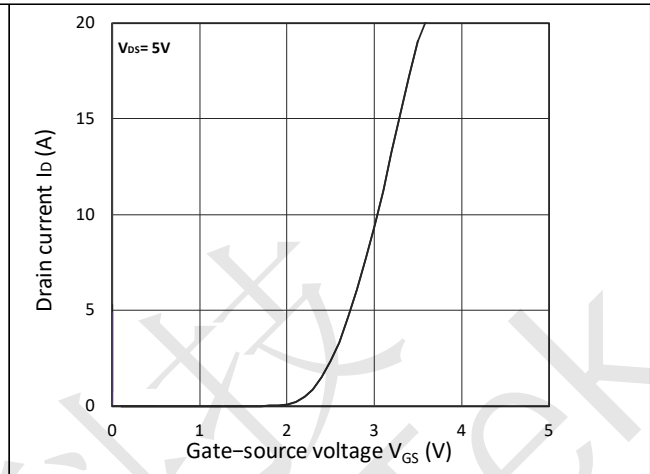

Figure 2. Transfer Characteristics

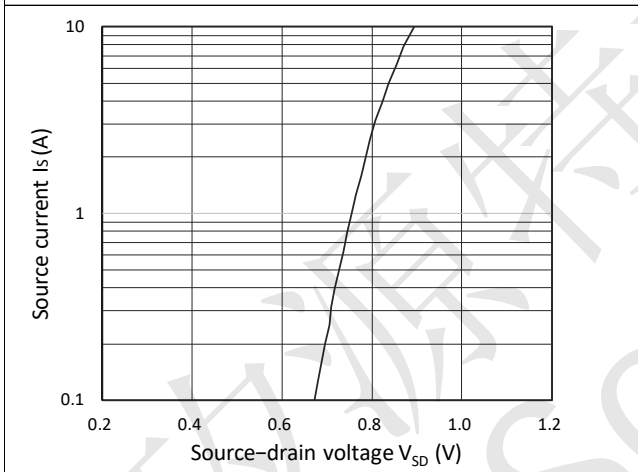

Figure 3. Forward Characteristics of Reverse

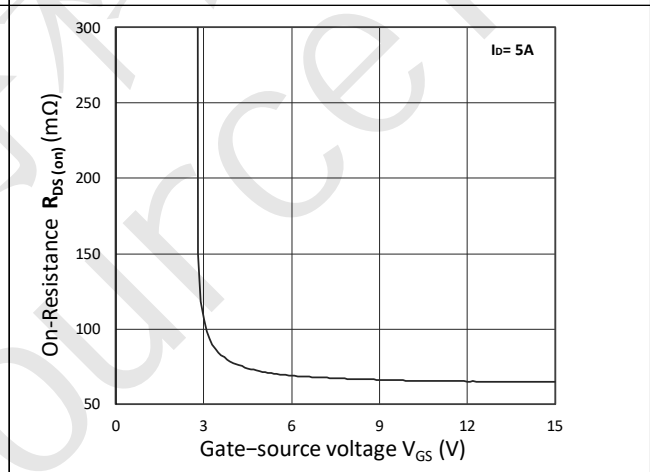

Figure 4. $R_{DS(on)}$ vs. V_{GS}

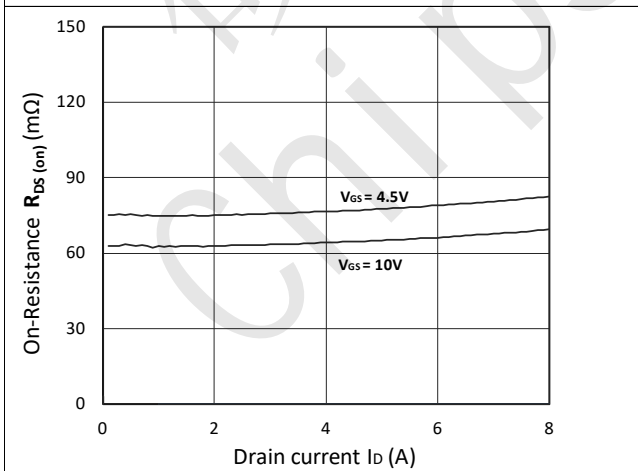

Figure 5. $R_{DS(on)}$ vs. I_D

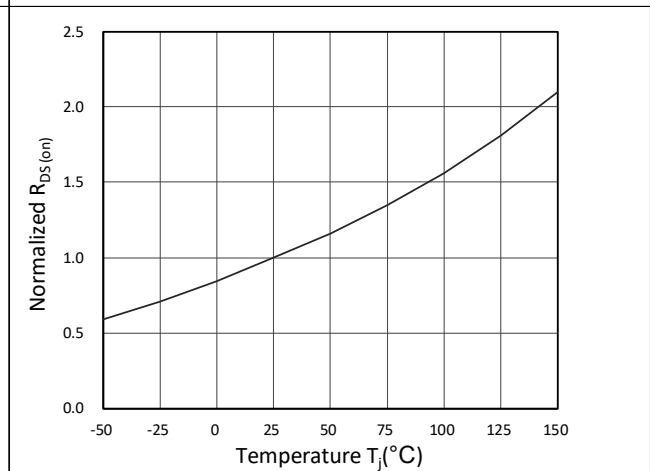

Figure 6. Normalized $R_{DS(on)}$ vs. Temperature



CST20N10 N-Ch 100V Fast Switching MOSFETs

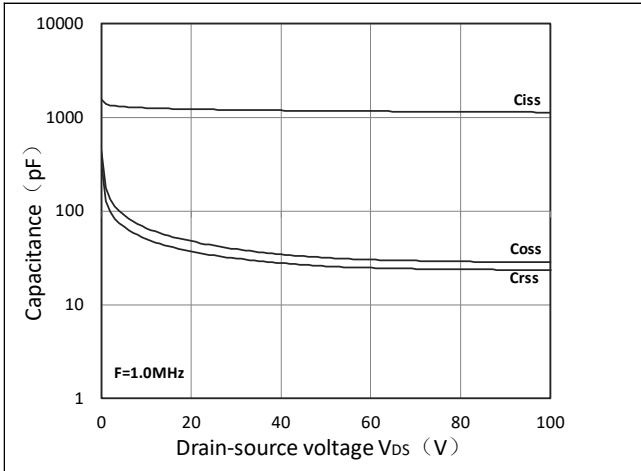

Figure 7. Capacitance Characteristics

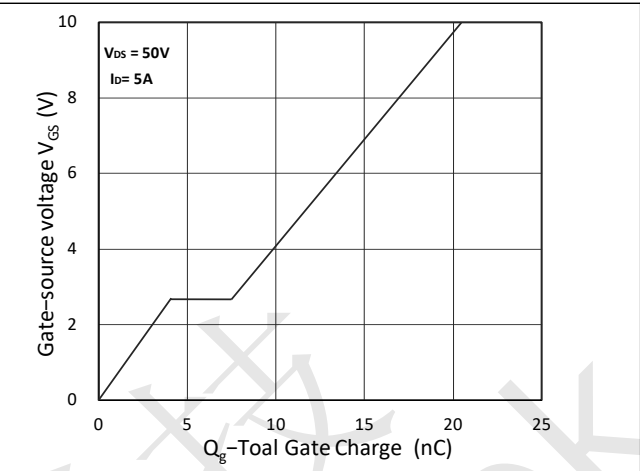

Figure 8. Gate Charge Characteristics

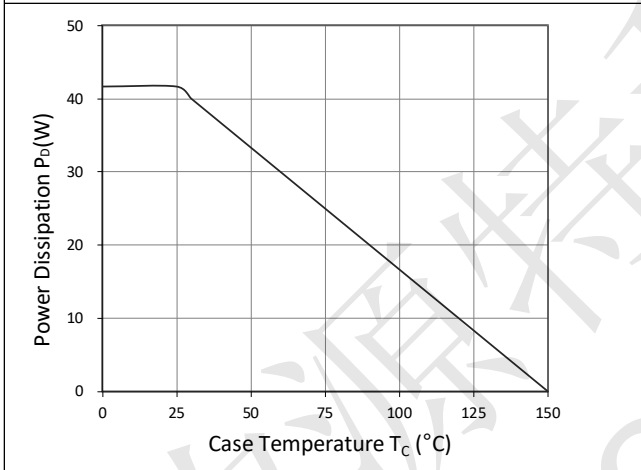

Figure 9. Power Dissipation

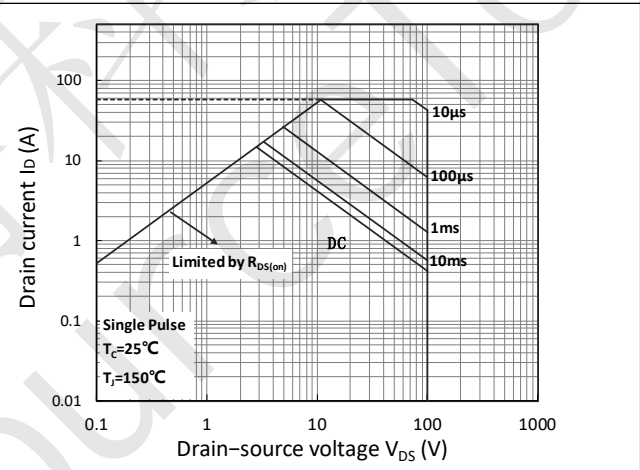

Figure 10. Safe Operating Area

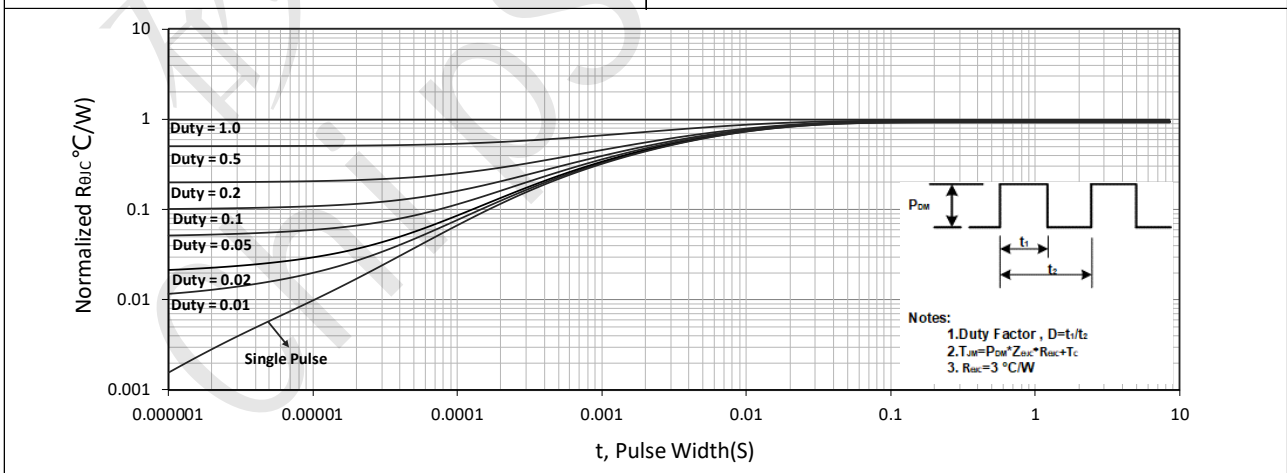
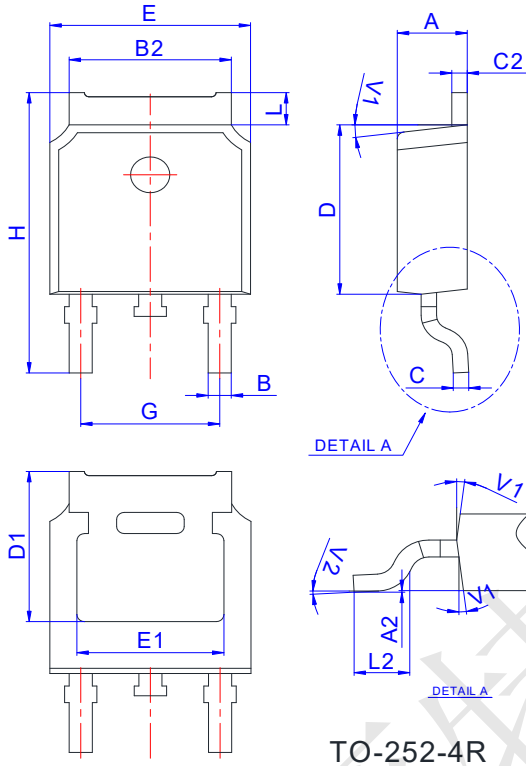

Figure 11. Normalized Maximum Transient Thermal Impedance



CST20N10 N-Ch 100V Fast Switching MOSFETs

CST20N10 TO-252 Package outline



Ref.	Dimensions					
	Millimeters			Inches		
	Min.	Typ.	Max.	Min.	Typ.	Max.
A	2.10		2.50	0.083		0.098
A2	0		0.10	0		0.004
B	0.66		0.86	0.026		0.034
B2	5.18		5.48	0.202		0.216
C	0.40		0.60	0.016		0.024
C2	0.44		0.58	0.017		0.023
D	5.90		6.30	0.232		0.248
D1	5.30REF			0.209REF		
E	6.40		6.80	0.252		0.268
E1	4.63			0.182		
G	4.47		4.67	0.176		0.184
H	9.50		10.70	0.374		0.421
L	1.09		1.21	0.043		0.048
L2	1.35		1.65	0.053		0.065
V1		7°			7°	
V2	0°		6°	0°		6°

CST20N10 Reel Specification-TO-252

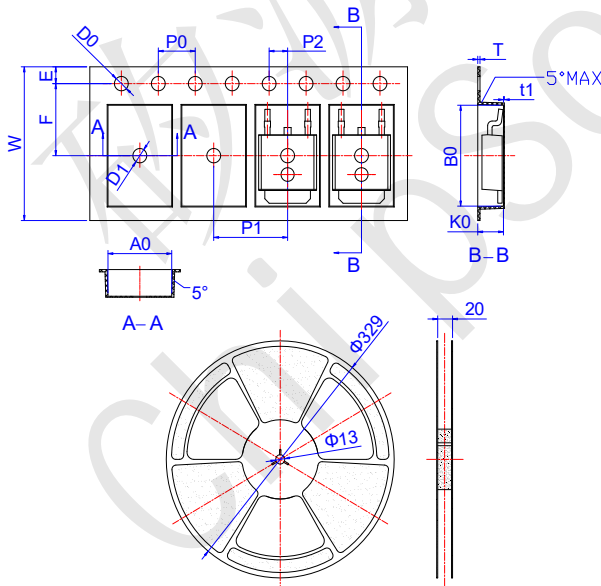

Ref.	Dimensions					
	Millimeters			Inches		
	Min.	Typ.	Max.	Min.	Typ.	Max.
W	15.90	16.00	16.10	0.626	0.630	0.634
E	1.65	1.75	1.85	0.065	0.069	0.073
F	7.40	7.50	7.60	0.291	0.295	0.299
D0	1.40	1.50	1.60	0.055	0.059	0.063
D1	1.40	1.50	1.60	0.055	0.059	0.063
P0	3.90	4.00	4.10	0.154	0.157	0.161
P1	7.90	8.00	8.10	0.311	0.315	0.319
P2	1.90	2.00	2.10	0.075	0.079	0.083
A0	6.85	6.90	7.00	0.270	0.271	0.276
B0	10.45	10.50	10.60	0.411	0.413	0.417
K0	2.68	2.78	2.88	0.105	0.109	0.113
T	0.24		0.27	0.009		0.011
t1	0.10			0.004		
10P0	39.80	40.00	40.20	1.567	1.575	1.583