



### CST30N03 N-Ch 30V Fast Switching MOSFETs



- ★ Super Low Gate Charge
- ★ 100% EAS Guaranteed
- ★ Green Device Available
- ★ Excellent CdV/dt effect decline
- ★ Advanced high cell density Trench technology

#### CST30P03 Product Summary

BVDSS	RDSON	ID
30V	9.5mΩ	30A

#### CST30N03 Description

The CST30N03 is the high cell density trenched N-ch MOSFETs, which provide excellent RDSON and gate charge for most of the synchronous buck converter applications.

The CST30N03 meet the RoHS and Green Product requirement, 100% EAS guaranteed with full function reliability approved.

#### CST30N03 TO252 Pin Configuration

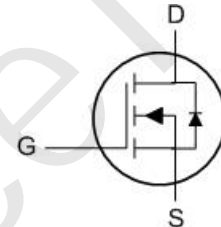
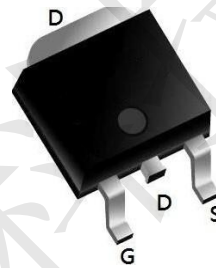

#### CST30N03 Absolute Maximum Ratings

Symbol	Parameter	Rating		Units
		10s	Steady State	
$V_{DS}$	Drain-Source Voltage	30		V
$V_{GS}$	Gate-Source Voltage	$\pm 20$		V
$I_D@T_C=25^\circ C$	Continuous Drain Current, $V_{GS} @ 10V^1$	30		A
$I_D@T_C=100^\circ C$	Continuous Drain Current, $V_{GS} @ 10V^1$	16		A
$I_{DM}$	Pulsed Drain Current <sup>2</sup>	88		A
EAS	Single Pulse Avalanche Energy <sup>3</sup>	18		mJ
$I_{AS}$	Avalanche Current	23.8		A
$P_D@T_C=25^\circ C$	Total Power Dissipation <sup>4</sup>	11.5		W
$T_{STG}$	Storage Temperature Range	-55 to 175		$^\circ C$
$T_J$	Operating Junction Temperature Range	-55 to 175		$^\circ C$

#### CST30N03 Thermal Data

Symbol	Parameter	Typ.	Max.	Unit
$R_{\theta JC}$	Thermal Resistance Junction-Case <sup>1</sup>	---	9.26	$^\circ C/W$



### CST30N03 N-Ch 30V Fast Switching MOSFETs

#### CST30N03 Electrical Characteristics (T<sub>J</sub>=25°C unless otherwise specified)

Symbol	Parameter	Test Condition	Min.	Typ.	Max.	Units
<b>Off Characteristic</b>						
V <sub>(BR)DSS</sub>	Drain-Source Breakdown Voltage	V <sub>GS</sub> =0V, I <sub>D</sub> =250μA	30	-	-	V
I <sub>DSS</sub>	Zero Gate Voltage Drain Current	V <sub>DS</sub> =30V, V <sub>GS</sub> =0V,	-	-	1.0	μA
I <sub>GSS</sub>	Gate to Body Leakage Current	V <sub>DS</sub> =0V, V <sub>GS</sub> =±20V	-	-	±100	nA
<b>On Characteristics</b>						
V <sub>GS(th)</sub>	Gate Threshold Voltage	V <sub>DS</sub> =V <sub>GS</sub> , I <sub>D</sub> =250μA	1.0	1.5	2.5	V
R <sub>DS(on)</sub>	Static Drain-Source on-Resistance <small>note3</small>	V <sub>GS</sub> =10V, I <sub>D</sub> =10A	-	9.5	13	mΩ
		V <sub>GS</sub> =4.5V, I <sub>D</sub> =5A	-	16	22.5	
<b>Dynamic Characteristics</b>						
C <sub>iss</sub>	Input Capacitance	V <sub>DS</sub> =15V, V <sub>GS</sub> =0V, f=1.0MHz	-	551	-	pF
C <sub>oss</sub>	Output Capacitance		-	108	-	pF
C <sub>rss</sub>	Reverse Transfer Capacitance		-	93	-	pF
Q <sub>g</sub>	Total Gate Charge	V <sub>DS</sub> =15V, I <sub>D</sub> =10A, V <sub>GS</sub> =10V	-	15	-	nC
Q <sub>gs</sub>	Gate-Source Charge		-	4.7	-	nC
Q <sub>gd</sub>	Gate-Drain("Miller") Charge		-	3.6	-	nC
<b>Switching Characteristics</b>						
t <sub>d(on)</sub>	Turn-on Delay Time	V <sub>DS</sub> =30V, I <sub>D</sub> =20A, R <sub>GEN</sub> =3Ω, V <sub>GS</sub> =10V	-	5	-	ns
t <sub>r</sub>	Turn-on Rise Time		-	8	-	ns
t <sub>d(off)</sub>	Turn-off Delay Time		-	21	-	ns
t <sub>f</sub>	Turn-off Fall Time		-	7	-	ns
<b>Drain-Source Diode Characteristics and Maximum Ratings</b>						
I <sub>S</sub>	Maximum Continuous Drain to Source Diode Forward Current		-	-	30	A
I <sub>SM</sub>	Maximum Pulsed Drain to Source Diode Forward Current		-	-	80	A
V <sub>SD</sub>	Drain to Source Diode Forward Voltage	V <sub>GS</sub> =0V, I <sub>S</sub> =20A	-	-	1.2	V
t <sub>rr</sub>	Body Diode Reverse Recovery Time	I <sub>F</sub> =20A, dI/dt=100A/μs	-	7	-	ns
Q <sub>rr</sub>	Body Diode Reverse Recovery Charge		-	5.9	-	nC

Notes:1. Repetitive Rating: Pulse Width Limited by Maximum Junction Temperature

2. EAS condition: T<sub>J</sub>=25°C, V<sub>DD</sub>=15V, V<sub>G</sub>=10V, R<sub>G</sub>=25Ω, L=0.5mH, I<sub>AS</sub>=8A

3. Pulse Test: Pulse Width≤300μs, Duty Cycle≤0.5%



CST30N03 N-Ch 30V Fast Switching MOSFETs

CST30N03 Typical Performance Characteristics

Figure 1: Output Characteristics

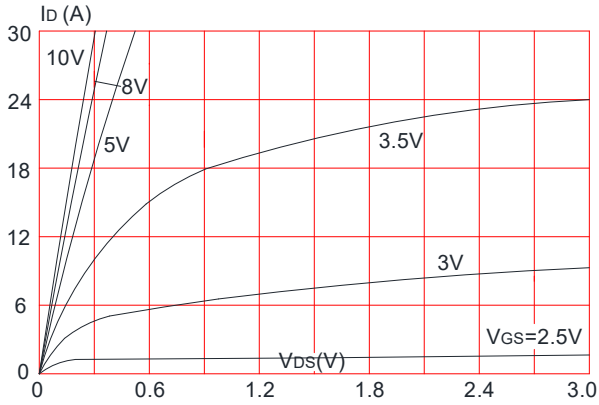

Figure 2: Typical Transfer Characteristics

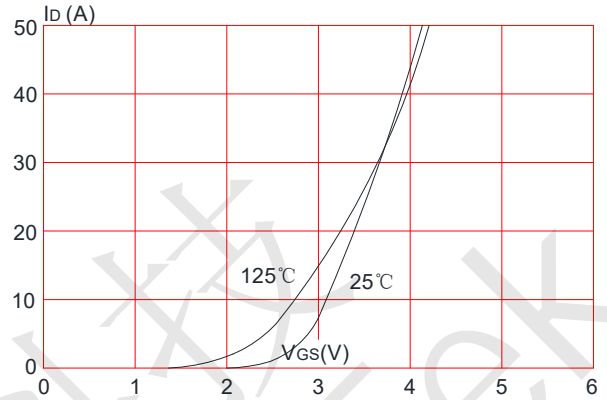

Figure 3: On-resistance vs. Drain Current

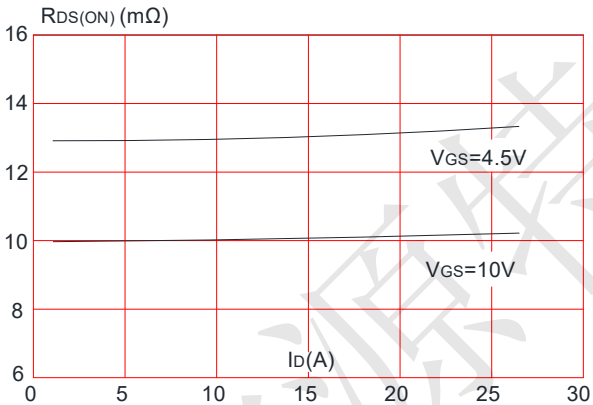

Figure 4: Body Diode Characteristics

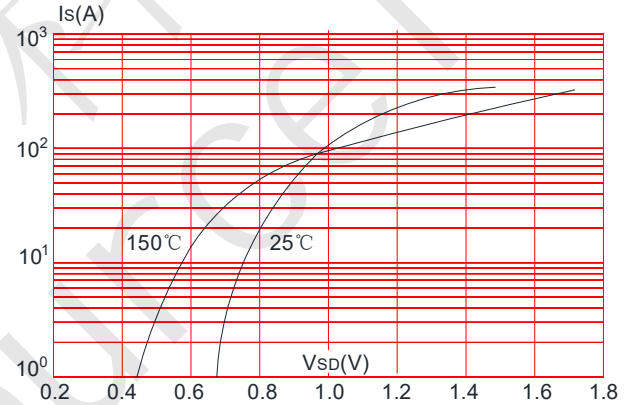

Figure 5: Gate Charge Characteristics

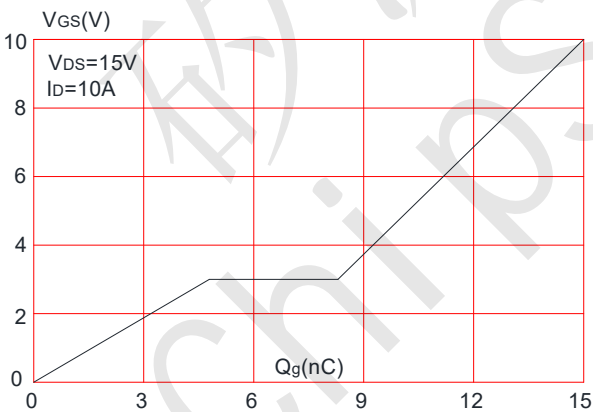
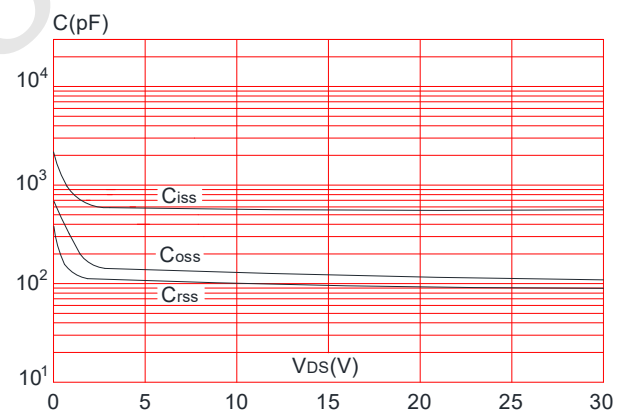

Figure 6: Capacitance Characteristics





### CST30N03 N-Ch 30V Fast Switching MOSFETs

**Figure 7:** Normalized Breakdown Voltage vs. Junction Temperature

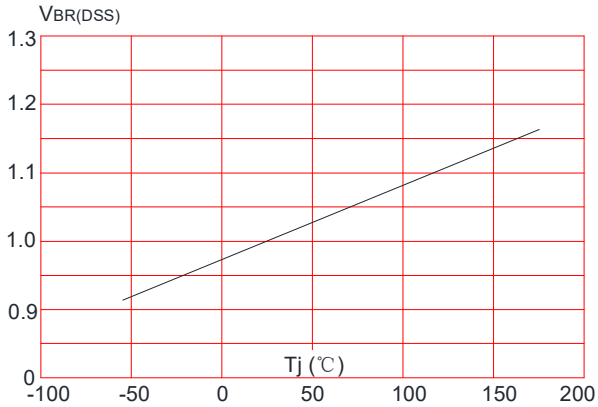

**Figure 8:** Normalized on Resistance vs. Junction Temperature

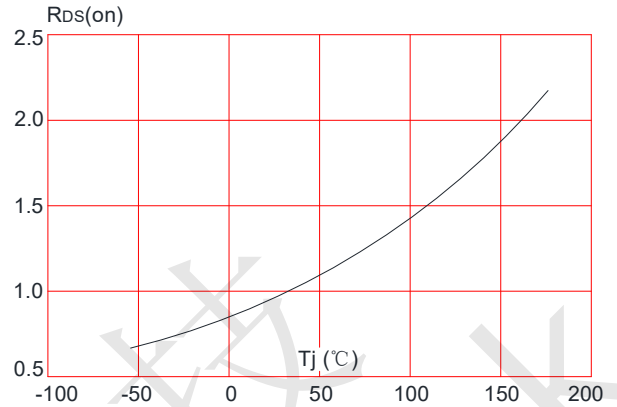

**Figure 9:** Maximum Safe Operating Area

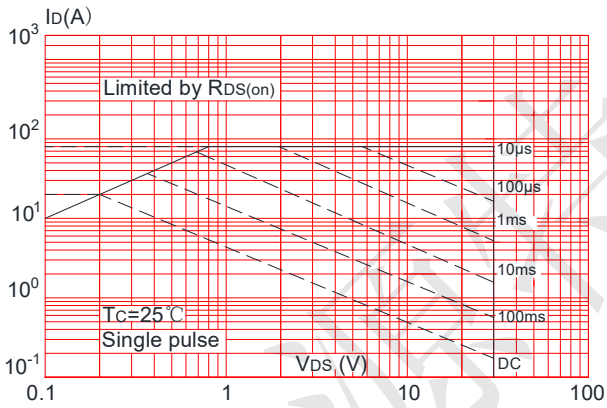

**Figure 10:** Maximum Continuous Drain Current vs. Case Temperature

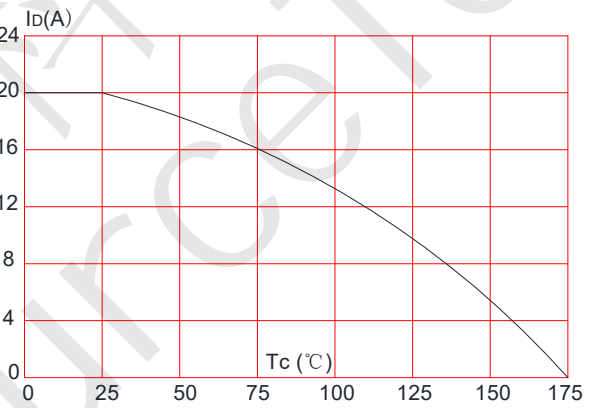

Maximum Effective Transient Thermal Impedance, Junction-to-Case

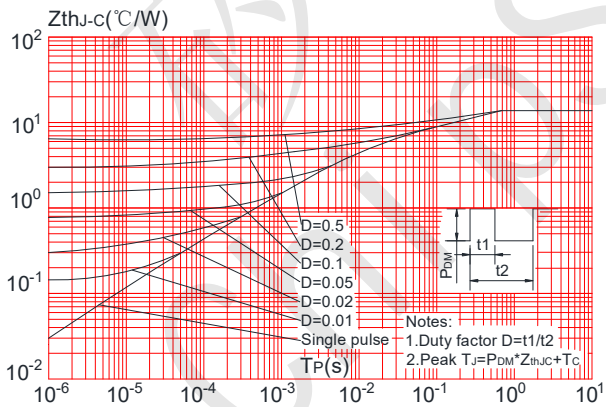



CST30N03 N-Ch 30V Fast Switching MOSFETs

CST30N03 Test Circuit

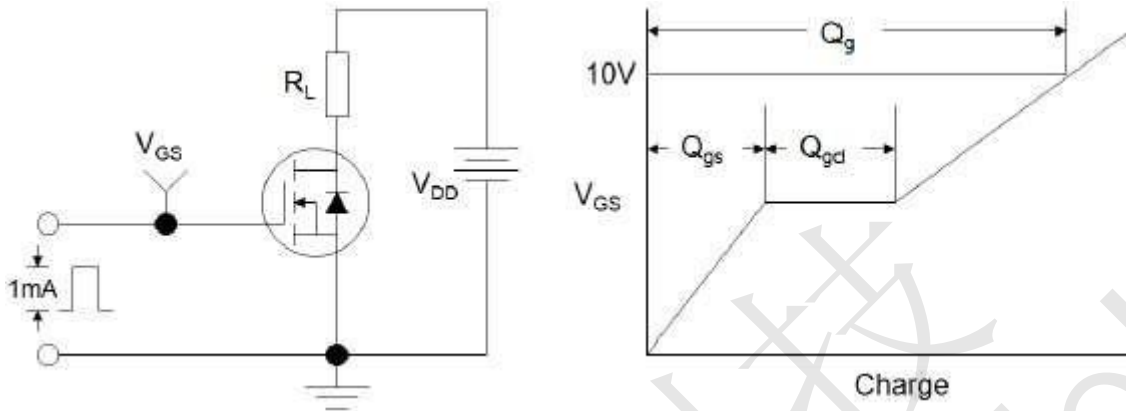

Figure1:Gate Charge Test Circuit & Waveform

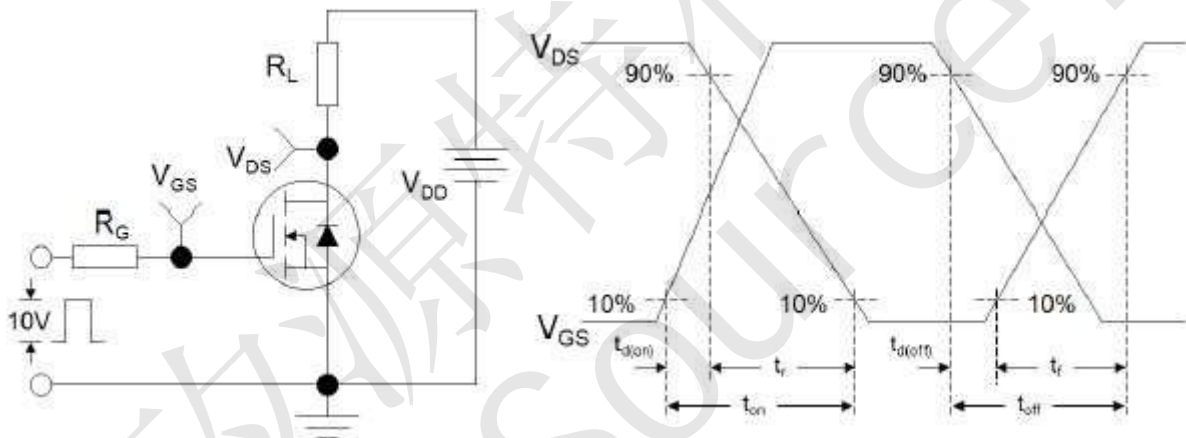

Figure 2: Resistive Switching Test Circuit & Waveforms

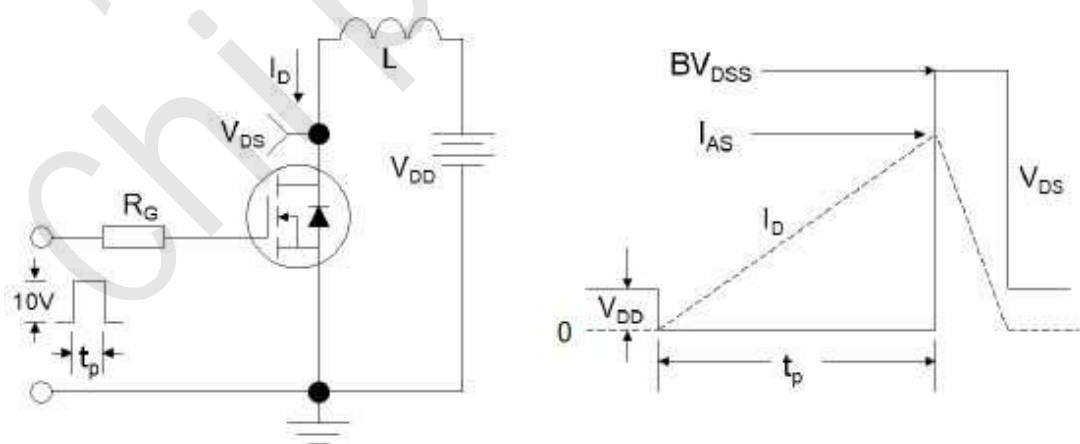
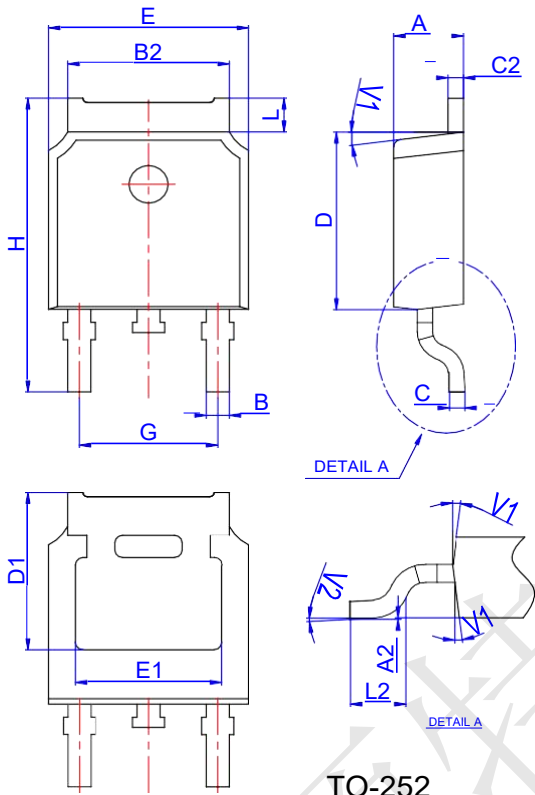

Figure 3:Unclamped Inductive Switching Test Circuit & Waveforms



CST30N03 N-Ch 30V Fast Switching MOSFETs

CST30N03 Package Mechanical Data TO252 4R



TO-252

Ref.	Dimensions					
	Millimeters			Inches		
	Min.	Typ.	Max.	Min.	Typ.	Max.
A	2.10		2.50	0.083		0.098
A2	0		0.10	0		0.004
B	0.66		0.86	0.026		0.034
B2	5.18		5.48	0.202		0.216
C	0.40		0.60	0.016		0.024
C2	0.44		0.58	0.017		0.023
D	5.90		6.30	0.232		0.248
D1	5.30REF			0.209REF		
E	6.40		6.80	0.252		0.268
E1	4.63			0.182		
G	4.47		4.67	0.176		0.184
H	9.50		10.70	0.374		0.421
L	1.09		1.21	0.043		0.048
L2	1.35		1.65	0.053		0.065
V1		7°		7°		
V2		0°	6°	0°		6°

CST30N03 Reel Specification-TO-252-4R

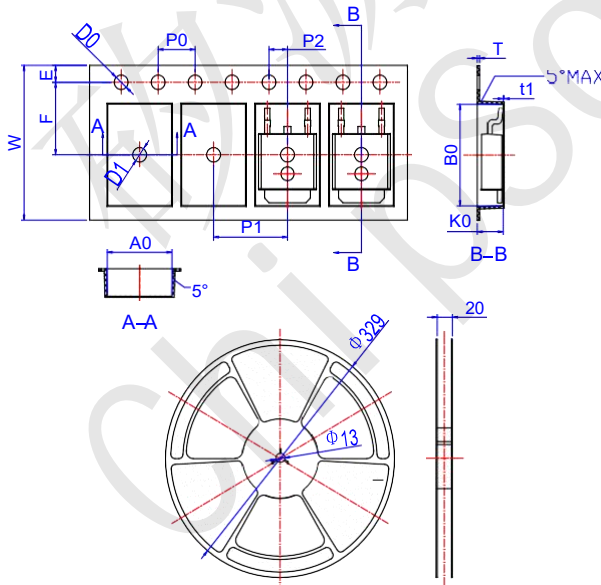

Ref.	Dimensions					
	Millimeters			Inches		
	Min.	Typ.	Max.	Min.	Typ.	Max.
W	15.90	16.00	16.10	0.626	0.630	0.634
E	1.65	1.75	1.85	0.065	0.069	0.073
F	7.40	7.50	7.60	0.291	0.295	0.299
D0	1.40	1.50	1.60	0.055	0.059	0.063
D1	1.40	1.50	1.60	0.055	0.059	0.063
P0	3.90	4.00	4.10	0.154	0.157	0.161
P1	7.90	8.00	8.10	0.311	0.315	0.319
P2	1.90	2.00	2.10	0.075	0.079	0.083
A0	6.85	6.90	7.00	0.270	0.271	0.276
B0	10.45	10.50	10.60	0.411	0.413	0.417
K0	2.68	2.78	2.88	0.105	0.109	0.113
T	0.24		0.27	0.009		0.011
t1	0.10			0.004		
10P0	39.80	40.00	40.20	1.567	1.575	1.583