



### CST30P10D P-Ch 30V Fast Switching MOSFETs



- ★ 100% EAS Guaranteed
- ★ Green Device Available
- ★ Super Low Gate Charge
- ★ Excellent CdV/dt effect decline
- ★ Advanced high cell density Trench technology

#### CST30P10D Product Summary

BVDSS	RDSON	ID
-30V	19mΩ	-10A

#### CST30P10D Description

The CST30P10D is the high cell density trenched P-ch MOSFETs, which provide excellent RDSON and gate charge for most of the synchronous buck converter applications.

The CST30P10D meet the RoHS and Green Product requirement, 100% EAS guaranteed with full function reliability approved.

#### CST30P10D DFN2020-6L Pin Configuration

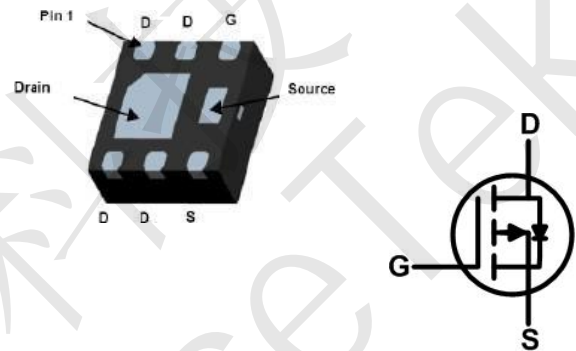

#### CST30P10D Absolute Maximum Ratings

Symbol	Parameter	Rating		Units
		10s	Steady State	
$V_{DS}$	Drain-Source Voltage	-30		V
$V_{GS}$	Gate-Source Voltage	$\pm 20$		V
$I_D@T_C=25^\circ C$	Continuous Drain Current, $V_{GS} @ -10V^1$	-10		A
$I_D@T_C=100^\circ C$	Continuous Drain Current, $V_{GS} @ -10V^1$	-8		A
$I_{DM}$	Pulsed Drain Current <sup>2</sup>	-36		A
EAS	Single Pulse Avalanche Energy <sup>3</sup>	25		mJ
$I_{AS}$	Avalanche Current	- 8		A
$P_D@T_C=25^\circ C$	Total Power Dissipation <sup>4</sup>	5.0		W
$P_D@T_A=25^\circ C$	Total Power Dissipation <sup>4</sup>	4.2	1.67	W
$T_{STG}$	Storage Temperature Range	-55 to 150		$^\circ C$
$T_J$	Operating Junction Temperature Range	-55 to 150		$^\circ C$

#### CST30P10D Thermal Data

Symbol	Parameter	Typ.	Max.	Unit
$R_{\theta JA}$	Thermal Resistance Junction-Ambient <sup>1</sup>	---	30	$^\circ C/W$



### CST30P10D P-Ch 30V Fast Switching MOSFETs

#### CST30P10D Electrical Characteristics ( $T_J=25^\circ\text{C}$ , unless otherwise noted)

Symbol	Parameter	Conditions	Min.	Typ.	Max.	Unit
$BV_{DSS}$	Drain-Source Breakdown Voltage	$V_{GS}=0V, I_D=-250\mu A$	-30	---	---	V
$\Delta BV_{DSS}/\Delta T_J$	$BV_{DSS}$ Temperature Coefficient	Reference to $25^\circ\text{C}$ , $I_D=-1\text{mA}$	---	-0.022	---	$V/^\circ\text{C}$
$R_{DS(ON)}$	Static Drain-Source On-Resistance <sup>2</sup>	$V_{GS}=-10V, I_D=-15A$	---	19	24	m $\Omega$
		$V_{GS}=-4.5V, I_D=-10A$	---	25	35	
$V_{GS(th)}$	Gate Threshold Voltage	$V_{GS}=V_{DS}, I_D=-250\mu A$	-1.0	---	-2.5	V
$\Delta V_{GS(th)}$	$V_{GS(th)}$ Temperature Coefficient		---	4.6	---	$\text{mV}/^\circ\text{C}$
$I_{DSS}$	Drain-Source Leakage Current	$V_{DS}=-24V, V_{GS}=0V, T_J=25^\circ\text{C}$	---	---	-1	$\mu\text{A}$
		$V_{DS}=-24V, V_{GS}=0V, T_J=55^\circ\text{C}$	---	---	-5	
$I_{GSS}$	Gate-Source Leakage Current	$V_{GS}=\pm 25V, V_{DS}=0V$	---	---	$\pm 100$	nA
$R_g$	Gate Resistance	$V_{DS}=0V, V_{GS}=0V, f=1\text{MHz}$	---	13	---	$\Omega$
$Q_g$	Total Gate Charge (-4.5V)	$V_{DS}=-15V, V_{GS}=-4.5V, I_D=-15A$	---	48	---	nC
$Q_{gs}$	Gate-Source Charge		---	9.5	---	
$Q_{gd}$	Gate-Drain Charge		---	8.0	---	
$T_{d(on)}$	Turn-On Delay Time	$V_{DD}=-15V, V_{GS}=-10V, R_G=3.3\Omega, I_D=-15A$	---	12	---	ns
$T_r$	Rise Time		---	14	---	
$T_{d(off)}$	Turn-Off Delay Time		---	190	---	
$T_f$	Fall Time		---	90	---	
$C_{iss}$	Input Capacitance	$V_{DS}=-15V, V_{GS}=0V, f=1\text{MHz}$	---	1150	---	pF
$C_{oss}$	Output Capacitance		---	155	---	
$C_{riss}$	Reverse Transfer Capacitance		---	139	---	

#### CST30P10D Diode Characteristics

Symbol	Parameter	Conditions	Min.	Typ.	Max.	Unit
$I_S$	Continuous Source Current <sup>1,5</sup>	$V_G=V_D=0V$ , Force Current	---	---	-10	A
$I_{SM}$	Pulsed Source Current <sup>2,5</sup>		---	---	-36	A
$V_{SD}$	Diode Forward Voltage <sup>2</sup>	$V_{GS}=0V, I_S=-1A, T_J=25^\circ\text{C}$	---	---	-1.2	V

Note :

- The data tested by surface mounted on a 1 inch<sup>2</sup> FR-4 board with 2OZ copper.
- The data tested by pulsed, pulse width  $\leq 300\mu\text{s}$ , duty cycle  $\leq 2\%$
- The EAS data shows Max. rating. The test condition is  $V_{DD}=-25V, V_{GS}=-10V, L=0.1\text{mH}, I_{AS}=-38A$
- The power dissipation is limited by  $150^\circ\text{C}$  junction temperature
- The data is theoretically the same as  $I_D$  and  $I_{DM}$ , in real applications, should be limited by total power dissipation.



CST30P10D Typical Performance Characteristics

Figure 1: Output Characteristics

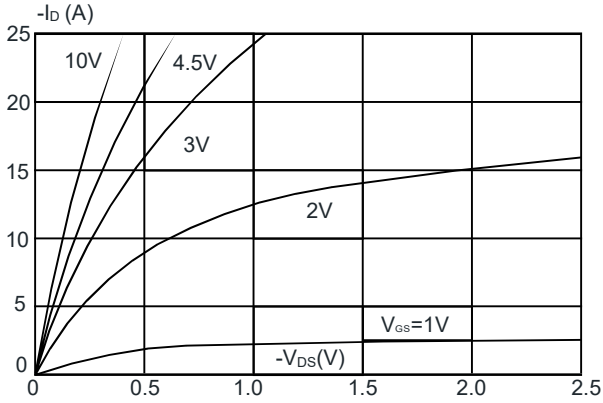

Figure 2: Typical Transfer Characteristics

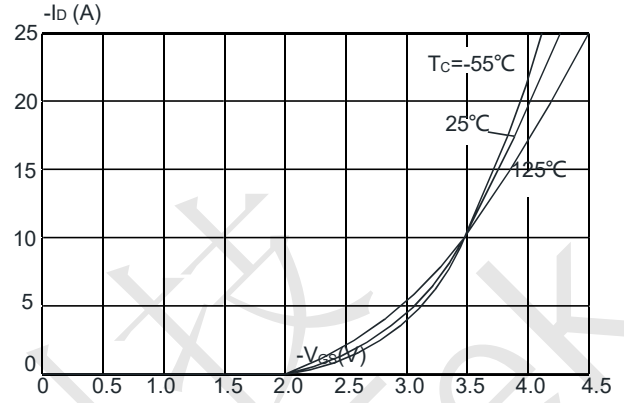

Figure 3: On-resistance vs. Drain Current

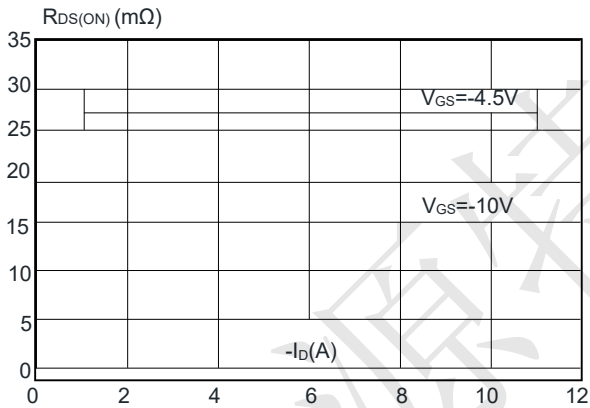

Figure 4: Body Diode Characteristics

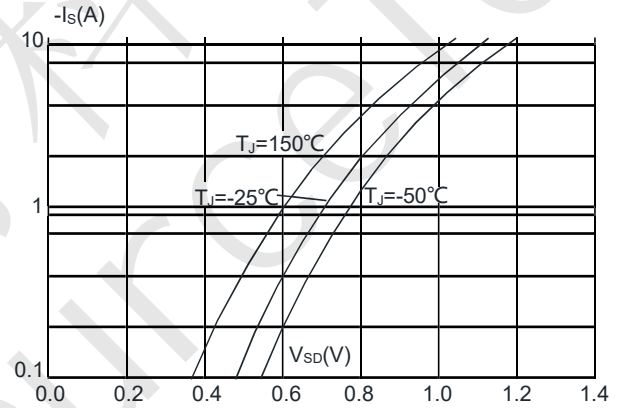

Figure 5: Gate Charge Characteristics

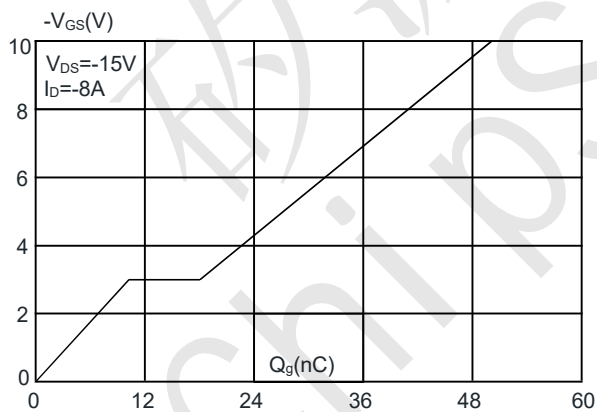
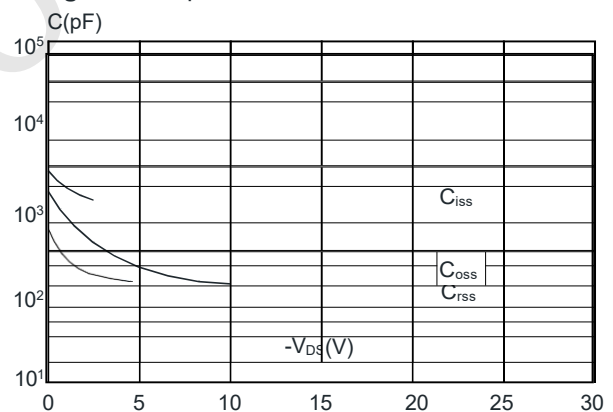

Figure 6: Capacitance Characteristics





### CST30P10D P-Ch 30V Fast Switching MOSFETs

**Figure 7:** Normalized Breakdown Voltage vs. Junction Temperature

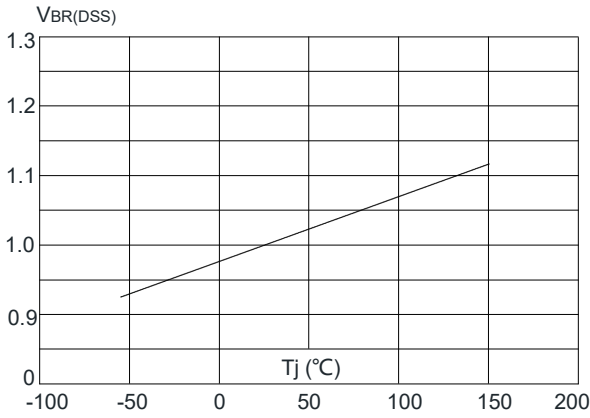

**Figure 8:** Normalized on Resistance vs. Junction Temperature

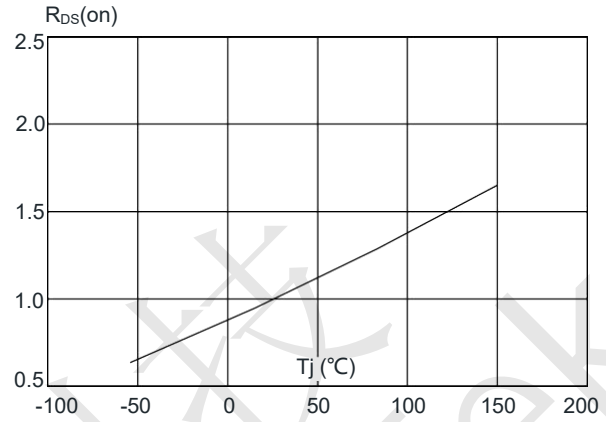

**Figure 9:** Maximum Safe Operating Area

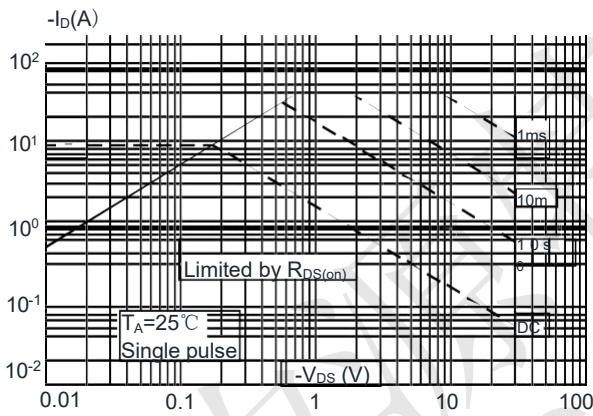

**Figure 10:** Maximum Continuous Drain Current vs. Ambient Temperature

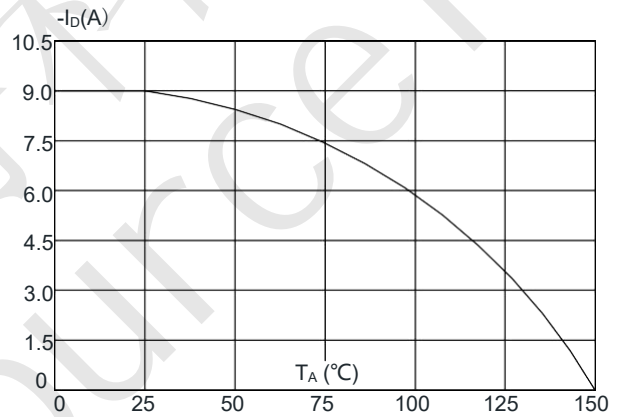

**Figure.11:** Maximum Effective Transient Thermal Impedance, Junction-to-Ambient

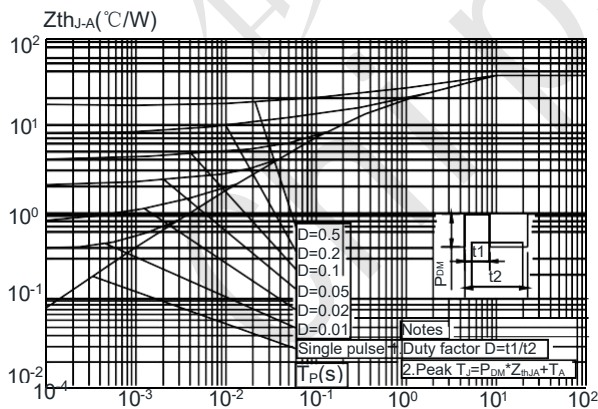



#### CST30P10D Test Circuit

##### Gate Charge Test Circuit & Waveform

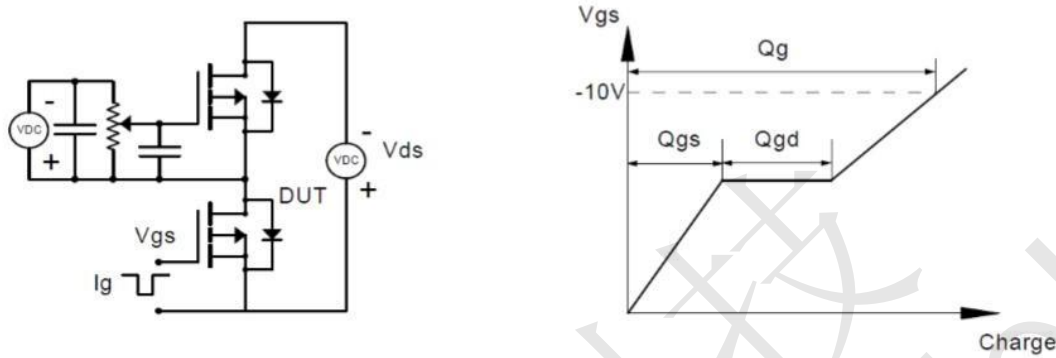

##### Resistive Switching Test Circuit & Waveforms

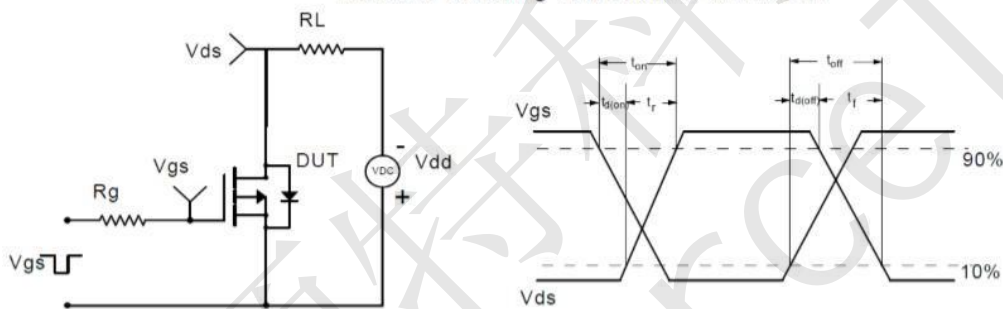

##### Unclamped Inductive Switching (UIS) Test Circuit & Waveforms

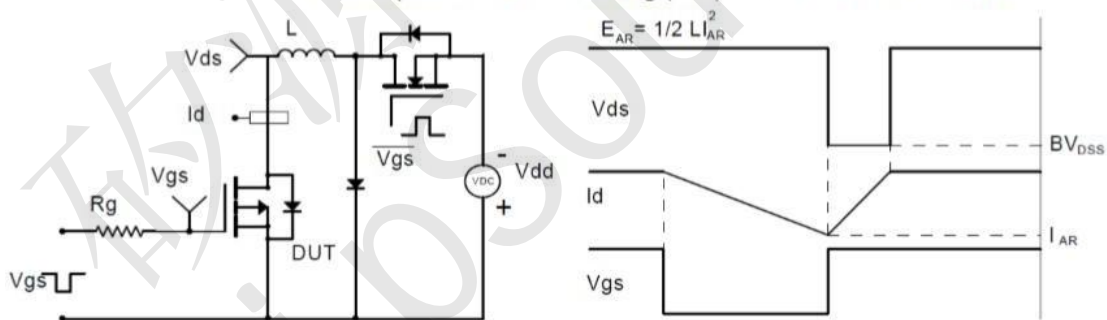

##### Diode Recovery Test Circuit & Waveforms

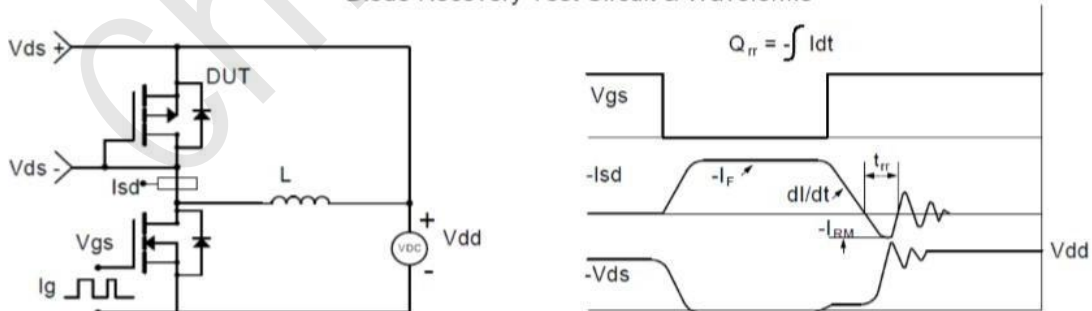



CST30P10D P-Ch 30V Fast Switching MOSFETs

CST30P10D DFN2020-6L Package Information

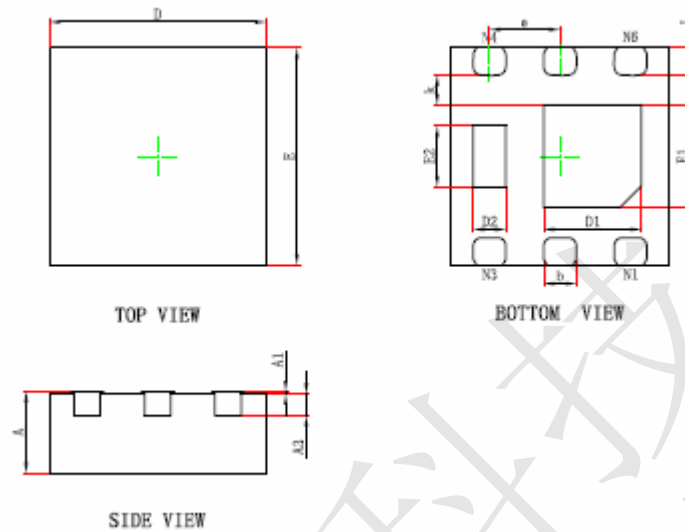

Symbol	Dimensions In Millimeters		Dimensions In Inches	
	Min.	Max.	Min.	Max.
A	0.700	0.800	0.028	0.031
A1	0.000	0.050	0.000	0.002
A3	0.203REF.		0.008REF.	
D	1.924	2.076	0.076	0.082
E	1.924	2.076	0.076	0.082
D1	0.800	1.000	0.031	0.039
E1	0.850	1.050	0.033	0.041
D2	0.200	0.400	0.008	0.016
E2	0.460	0.660	0.018	0.026
k	0.200MIN.		0.008MIN.	
b	0.250	0.350	0.010	0.014
e	0.650TYP.		0.026TYP.	
L	0.174	0.326	0.007	0.013