



CST4822A Dual N-Ch 30V Fast Switching MOSFETs

- ★ Super Low Gate Charge
- ★ 100% EAS Guaranteed
- ★ Green Device Available
- ★ Excellent CdV/dt effect decline
- ★ Advanced high cell density Trench technology



CST4822A Product Summary

BVDSS	RDSON	ID
30V	15mΩ	9.5A

CST4822A Description

The CST4822A is the high cell density trenched N-ch MOSFETs, which provide excellent RDSON and gate charge for most of the synchronous buck converter applications. The CST4822A meet the RoHS and Green Product requirement, 100% EAS guaranteed with full function reliability approved.

CST4822A Dual SOP8 Pin Configuration

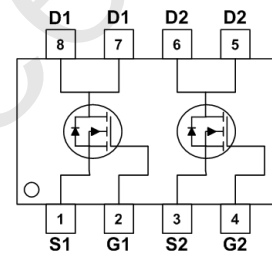
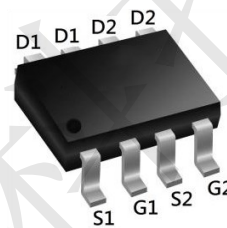

CST4822A Absolute Maximum Ratings

Symbol	Parameter	Rating	Units
V_{DS}	Drain-Source Voltage	30	V
V_{GS}	Gate-Source Voltage	± 20	V
$I_D@T_A=25^\circ C$	Continuous Drain Current, $V_{GS} @ 10V^1$	9.5	A
$I_D@T_A=70^\circ C$	Continuous Drain Current, $V_{GS} @ 10V^1$	5.8	A
I_{DM}	Pulsed Drain Current ²	37	A
EAS	Single Pulse Avalanche Energy ³	12.1	mJ
I_{AS}	Avalanche Current	--	A
$P_D@T_A=25^\circ C$	Total Power Dissipation ⁴	2.8	W
T_{STG}	Storage Temperature Range	-55 to 150	$^\circ C$
T_J	Operating Junction Temperature Range	-55 to 150	$^\circ C$

CST4822A Thermal Data

Symbol	Parameter	Typ.	Max.	Unit
$R_{\theta JA}$	Thermal Resistance Junction-ambient ¹	---	---	$^\circ C/W$
$R_{\theta JC}$	Thermal Resistance Junction-Case ¹	---	46	$^\circ C/W$



CST4822A Dual N-Ch 30V Fast Switching MOSFETs

CST4822A Electrical Characteristics (T_J=25°C unless otherwise specified)

Symbol	Parameter	Test Condition	Min.	Typ.	Max.	Units
Off Characteristic						
V _{(BR)DSS}	Drain-Source Breakdown Voltage	V _{GS} =0V, I _D =250μA	30	-	-	V
I _{DSS}	Zero Gate Voltage Drain Current	V _{DS} =30V, V _{GS} = 0V,	-	-	1.0	μA
I _{GSS}	Gate to Body Leakage Current	V _{DS} =0V, V _{GS} = ±20V	-	-	±100	nA
On Characteristics						
V _{GS(th)}	Gate Threshold Voltage	V _{DS} =V _{GS} , I _D =250μA	1.0	1.5	2.5	V
R _{DS(on)}	Static Drain-Source on-Resistance <small>note3</small>	V _{GS} =10V, I _D =5A	-	15	20	mΩ
		V _{GS} =4.5V, I _D =3A	-	21	29	
Dynamic Characteristics						
C _{iss}	Input Capacitance	V _{DS} =15V, V _{GS} =0V, f=1.0MHz	-	490	-	pF
C _{oss}	Output Capacitance		-	79	-	pF
C _{rss}	Reverse Transfer Capacitance		-	61	-	pF
Q _g	Total Gate Charge	V _{DS} =15V, I _D =5.8A, V _{GS} =10V	-	10	-	nC
Q _{gs}	Gate-Source Charge		-	1.7	-	nC
Q _{gd}	Gate-Drain("Miller") Charge		-	2.5	-	nC
Switching Characteristics						
t _{d(on)}	Turn-on Delay Time	V _{DS} =15V, I _D =3A, V _{GS} =10V, R _{REN} =3Ω	-	6	-	ns
t _r	Turn-on Rise Time		-	15	-	ns
t _{d(off)}	Turn-off Delay Time		-	17	-	ns
t _f	Turn-off Fall Time		-	17	-	ns
Drain-Source Diode Characteristics and Maximum Ratings						
I _S	Maximum Continuous Drain to Source Diode Forward Current		-	-	9	A
I _{SM}	Maximum Pulsed Drain to Source Diode Forward Current		-	-	36	A
V _{SD}	Drain to Source Diode Forward Voltage	V _{GS} =0V, I _S =9A	-	-	1.2	V
trr	Body Diode Reverse Recovery Time	I _F =5A, di/dt=100A/μs	-	7	-	ns
Qrr	Body Diode Reverse Recovery Charge		-	2	-	nC

Notes:1. Repetitive Rating: Pulse Width Limited by Maximum Junction Temperature

2. EAS condition : T_J=25°C, V_{DD}=15V, V_G=10V, L=0.5mH, R_g=25Ω, I_{AS}=6A

3. Pulse Test: Pulse Width≤300μs, Duty Cycle≤0.5%



CST4822A Dual N-Ch 30V Fast Switching MOSFETs

CST4822A Typical Performance Characteristics

Figure 1: Output Characteristics

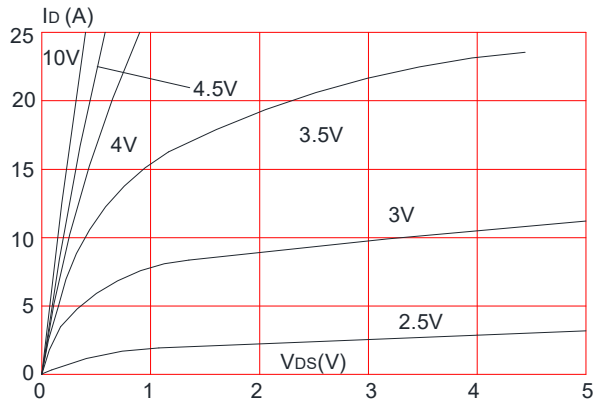

Figure 2: Typical Transfer Characteristics

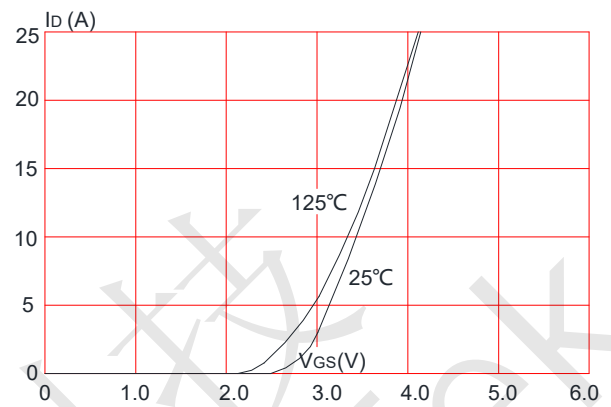

Figure 3: On-resistance vs. Drain Current

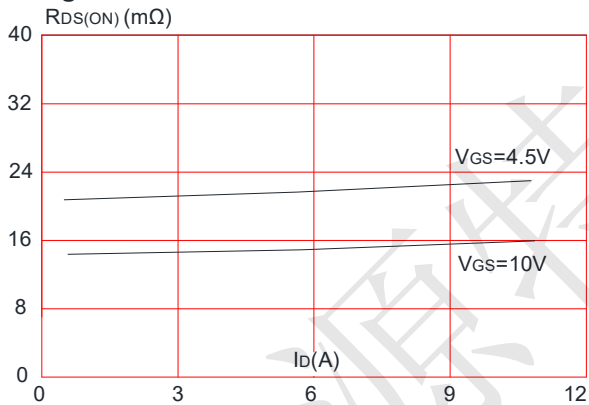

Figure 4: Body Diode Characteristics

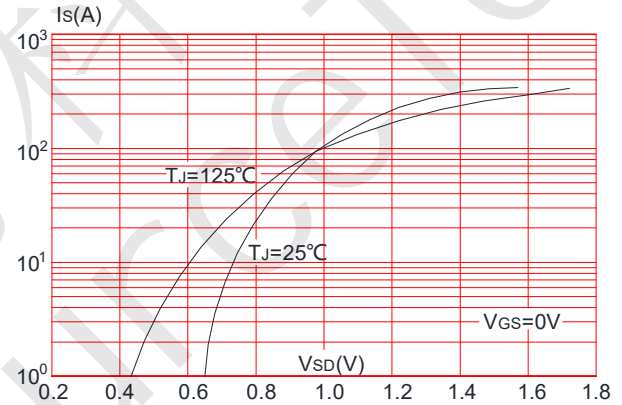

Figure 5: Gate Charge Characteristics

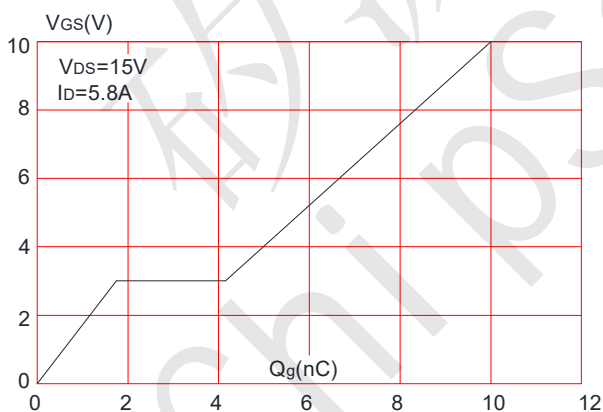
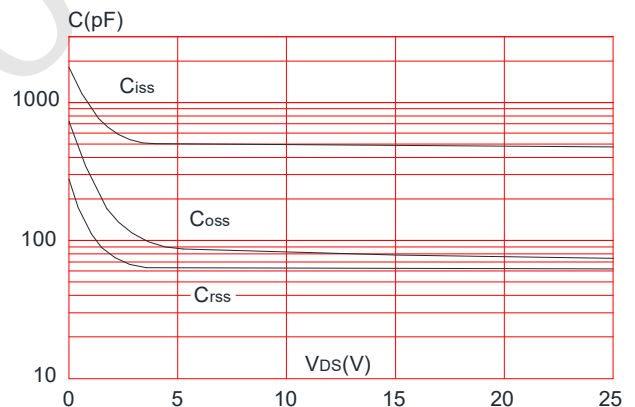

Figure 6: Capacitance Characteristics





CST4822A Dual N-Ch 30V Fast Switching MOSFETs

Figure 7: Normalized Breakdown Voltage vs. Junction Temperature

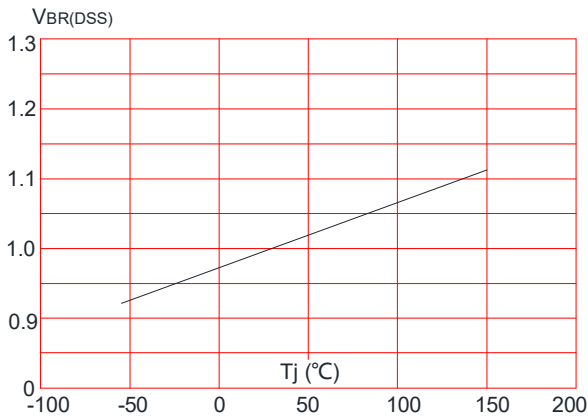

Figure 8: Normalized on Resistance vs. Junction Temperature

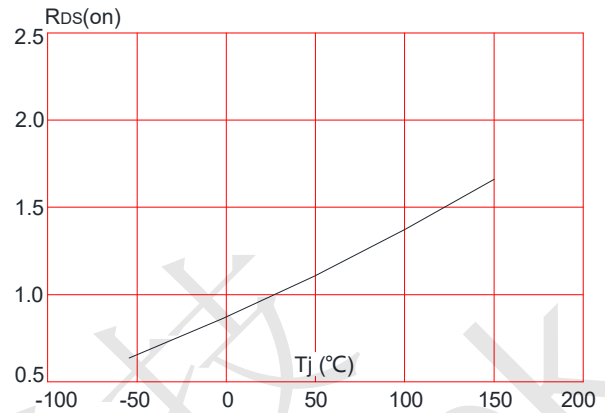

Figure 9: Maximum Safe Operating Area

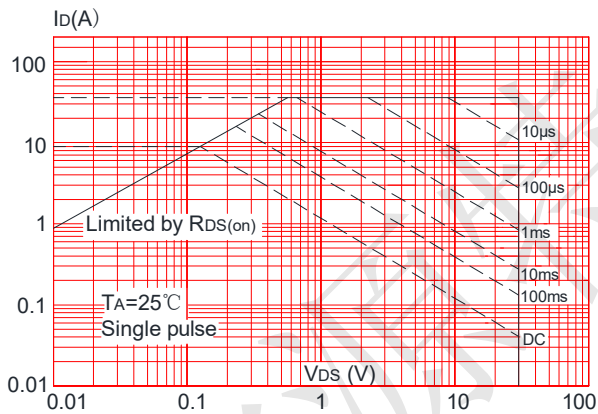

Figure 10: Maximum Continuous Drain Current vs. Ambient Temperature

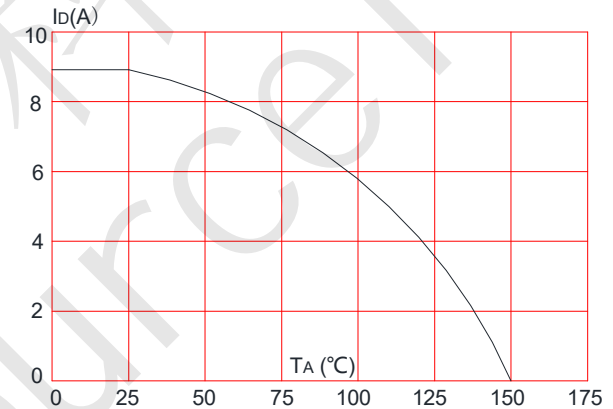
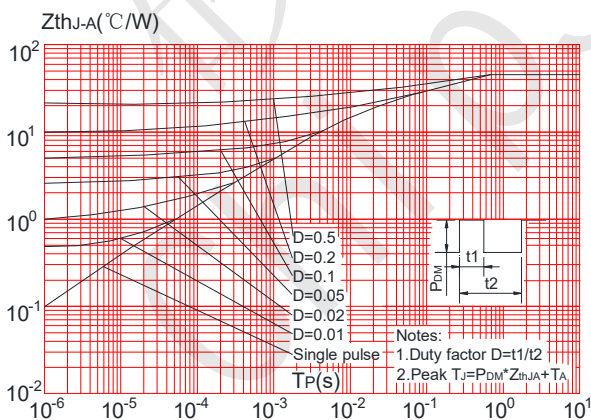

Figure 11: Maximum Effective Transient Thermal Impedance, Junction-to-Ambient





CST4822A Dual N-Ch 30V Fast Switching MOSFETs

CST4822A Package Mechanical Data-SOP-8

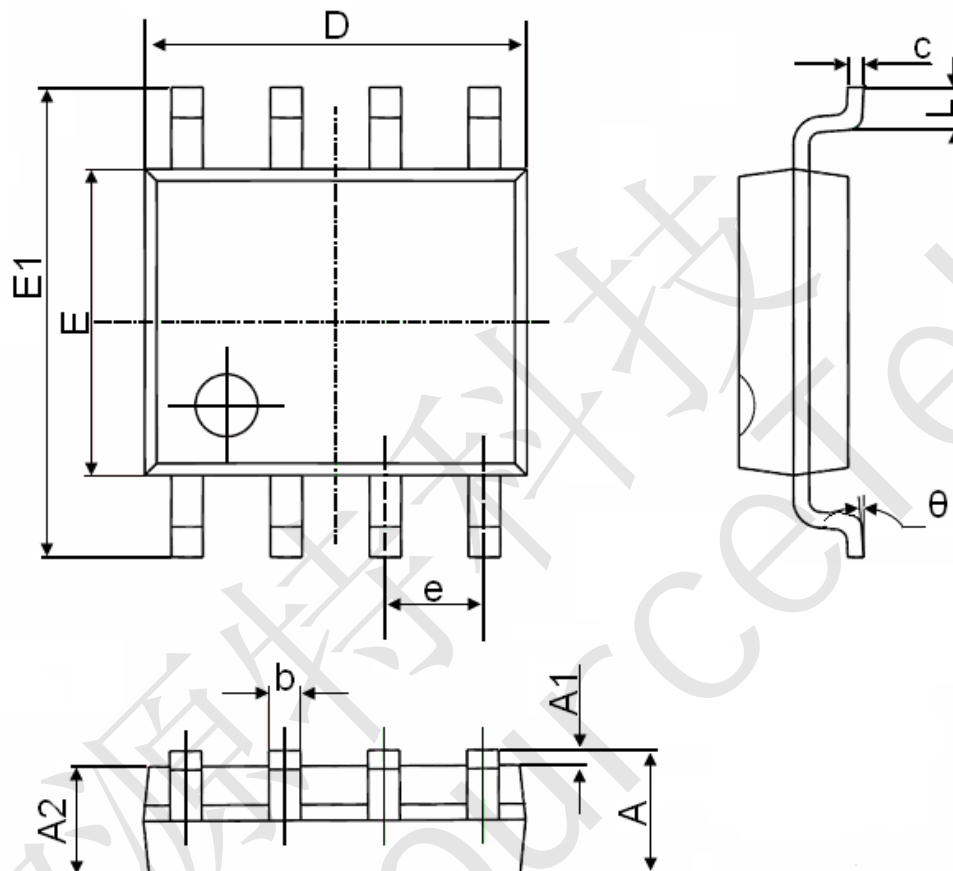

Symbol	Dimensions In Millimeters		Dimensions In Inches	
	Min.	Max.	Min.	Max.
A	1.350	1.750	0.053	0.069
A1	0.100	0.250	0.004	0.010
A2	1.350	1.550	0.053	0.061
b	0.330	0.510	0.013	0.020
c	0.170	0.250	0.006	0.010
D	4.700	5.100	0.185	0.200
E	3.800	4.000	0.150	0.157
E1	5.800	6.200	0.228	0.244
e	1.270(BSC)		0.050(BSC)	
L	0.400	1.270	0.016	0.050
θ	0°	8°	0°	8°