



### CST80N03B N-Ch 30V Fast Switching MOSFETs



- ★ Super Low Gate Charge
- ★ 100% EAS Guaranteed
- ★ Green Device Available
- ★ Excellent CdV/dt effect decline
- ★ Advanced high cell density Trench technology

#### CST80N03B Product Summary

BVDSS	RDSON	ID
30V	4.0mΩ	80 A

#### CST80N03B Description

The CST80N03B is the high cell density trenched N-ch MOSFETs, which provide excellent RDSON and gate charge for most of the synchronous buck converter applications.

The CST80N03B meet the RoHS and Green Product requirement, 100% EAS guaranteed with full function reliability approved.

#### CST80N03B TO252 Pin Configuration

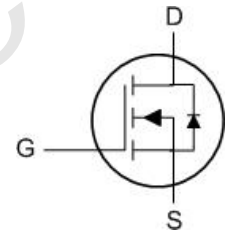
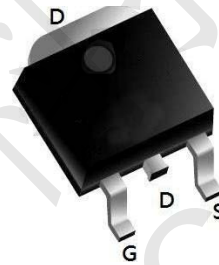

#### CST80N03B Absolute Maximum Ratings (T<sub>C</sub>=25°C unless otherwise specified)

Symbol	Parameter	Max.	Units
V <sub>DSS</sub>	Drain-Source Voltage	30	V
V <sub>GSS</sub>	Gate-Source Voltage	±20	V
I <sub>D</sub>	Continuous Drain Current	T <sub>C</sub> = 25°C	80
		T <sub>C</sub> = 100°C	46
I <sub>DM</sub>	Pulsed Drain Current <sup>note1</sup>	280	A
E <sub>AS</sub>	Single Pulsed Avalanche Energy <sup>note2</sup>	56	mJ
P <sub>D</sub>	Power Dissipation	T <sub>C</sub> = 25°C	42
R <sub>θJC</sub>	Thermal Resistance, Junction to Case	2.98	°C/W
T <sub>J</sub> , T <sub>STG</sub>	Operating and Storage Temperature Range	-55 to +150	°C



### CST80N03B N-Ch 30V Fast Switching MOSFETs

#### CST80N03B Electrical Characteristics (T<sub>J</sub>=25°C unless otherwise specified)

Symbol	Parameter	Test Condition	Min.	Typ.	Max.	Units
<b>Off Characteristic</b>						
V <sub>(BR)DSS</sub>	Drain-Source Breakdown Voltage	V <sub>GS</sub> =0V, I <sub>D</sub> =250μA	30	-	-	V
I <sub>DSS</sub>	Zero Gate Voltage Drain Current	V <sub>DS</sub> =30V, V <sub>GS</sub> =0V,	-	-	1.0	μA
I <sub>GSS</sub>	Gate to Body Leakage Current	V <sub>DS</sub> =0V, V <sub>GS</sub> =±20V	-	-	±100	nA
<b>On Characteristics</b>						
V <sub>GS(th)</sub>	Gate Threshold Voltage	V <sub>DS</sub> =V <sub>GS</sub> , I <sub>D</sub> =250μA	1.0	1.5	2.5	V
R <sub>DS(on)</sub>	Static Drain-Source on-Resistance note3	V <sub>GS</sub> =10V, I <sub>D</sub> =30A	-	4.0	5.3	mΩ
		V <sub>GS</sub> =4.5V, I <sub>D</sub> =20A	-	6.7	9.4	
<b>Dynamic Characteristics</b>						
C <sub>iss</sub>	Input Capacitance	V <sub>DS</sub> =15V, V <sub>GS</sub> =0V, f=1.0MHz	-	1614	-	pF
C <sub>oss</sub>	Output Capacitance		-	245	-	pF
C <sub>rss</sub>	Reverse Transfer Capacitance		-	215	-	pF
Q <sub>g</sub>	Total Gate Charge	V <sub>DS</sub> =15V, I <sub>D</sub> =30A, V <sub>GS</sub> =10V	-	33.7	-	nC
Q <sub>gs</sub>	Gate-Source Charge		-	8.5	-	nC
Q <sub>gd</sub>	Gate-Drain("Miller") Charge		-	7.5	-	nC
<b>Switching Characteristics</b>						
t <sub>d(on)</sub>	Turn-on Delay Time	V <sub>DS</sub> =15V, I <sub>D</sub> =30A, R <sub>GEN</sub> =3Ω, V <sub>GS</sub> =10V	-	7.5	-	ns
t <sub>r</sub>	Turn-on Rise Time		-	14.5	-	ns
t <sub>d(off)</sub>	Turn-off Delay Time		-	35.2	-	ns
t <sub>f</sub>	Turn-off Fall Time		-	9.6	-	ns
<b>Drain-Source Diode Characteristics and Maximum Ratings</b>						
I <sub>S</sub>	Maximum Continuous Drain to Source Diode Forward Current		-	-	80	A
I <sub>SM</sub>	Maximum Pulsed Drain to Source Diode Forward Current		-	-	280	A
V <sub>SD</sub>	Drain to Source Diode Forward Voltage	V <sub>GS</sub> =0V, I <sub>S</sub> =30A	-	-	1.2	V

Notes: 1. Repetitive Rating: Pulse Width Limited by Maximum Junction Temperature

2. EAS condition: T<sub>J</sub>=25°C, V<sub>DD</sub>=15V, V<sub>G</sub>=10V, R<sub>G</sub>=25Ω, L=0.5mH, I<sub>AS</sub>=15A

3. Pulse Test: Pulse Width≤300μs, Duty Cycle≤0.5%

#### Notes:

1. Repetitive Rating: Pulse width limited by maximum junction temperature.

2. Surface Mounted on FR4 Board, t ≤ 10 sec.

3. Pulse Test: Pulse Width ≤ 300μs, Duty Cycle ≤ 2%.

4. Guaranteed by design, not subject to production

5. EAS condition: T<sub>J</sub>=25°C, V<sub>DD</sub>=15V, V<sub>G</sub>=10V, L=0.5mH, R<sub>G</sub>=25Ω, I<sub>AS</sub>=35A



### CST80N03B N-Ch 30V Fast Switching MOSFETs

#### CST80N03B Typical Performance Characteristics

**Figure 1: Output Characteristics**

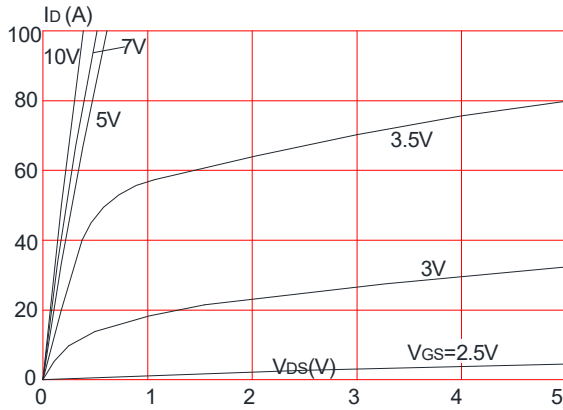

**Figure 2: Typical Transfer Characteristics**

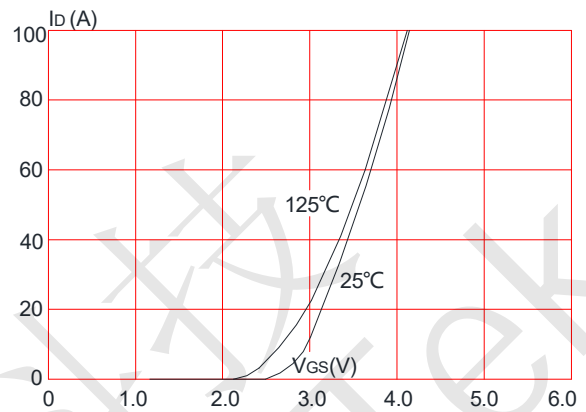

**Figure 3: On-resistance vs. Drain Current**

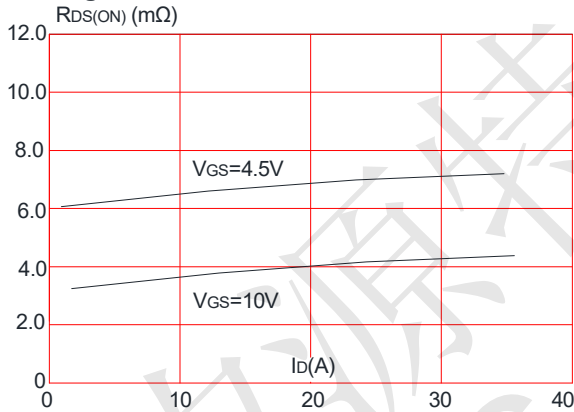

**Figure 4: Body Diode Characteristics**

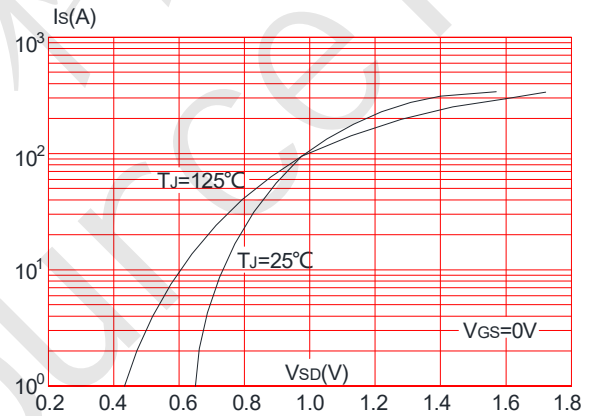

**Figure 5: Gate Charge Characteristics**

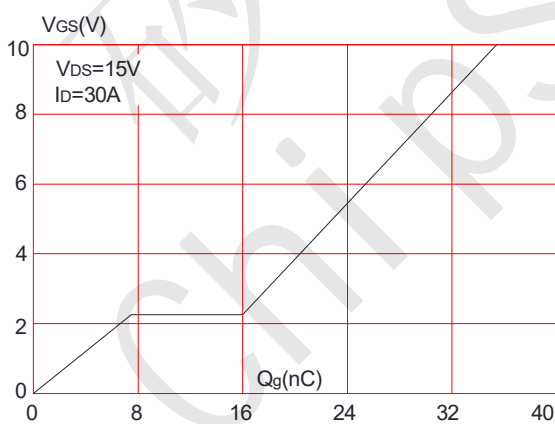

**Figure 6: Capacitance Characteristics**

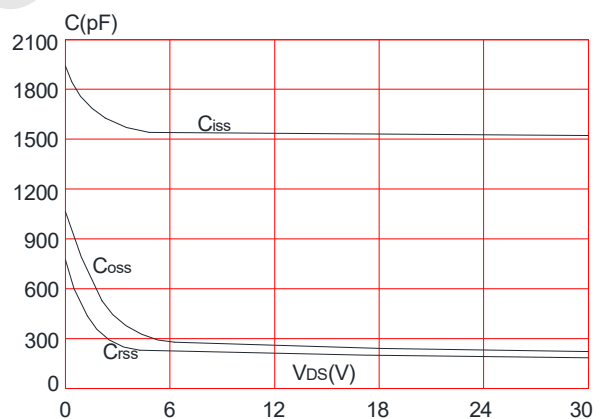



### CST80N03B N-Ch 30V Fast Switching MOSFETs

**Figure 7:** Normalized Breakdown Voltage vs. Junction Temperature

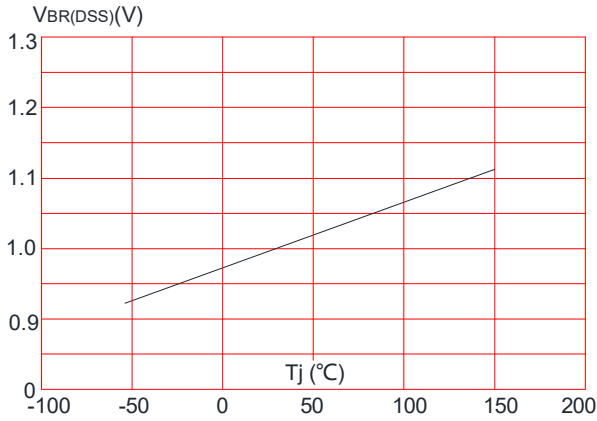

**Figure 8:** Normalized on Resistance vs. Junction Temperature

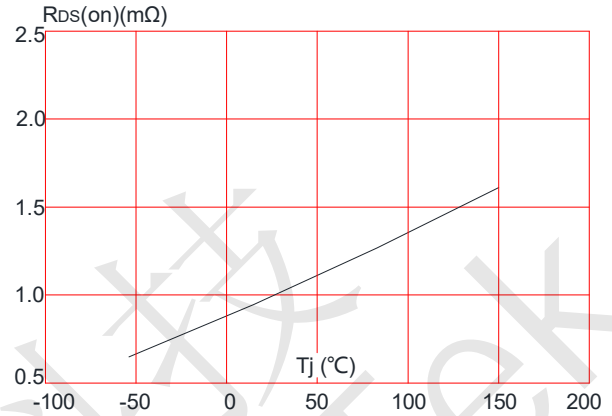

**Figure 9:** Maximum Safe Operating Area

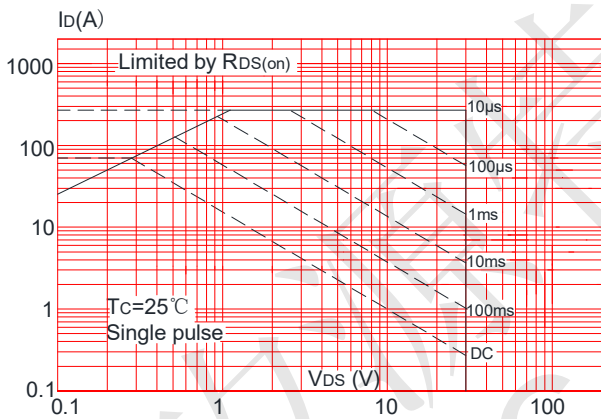

**Figure 10:** Maximum Continuous Drain Current vs. Case Temperature

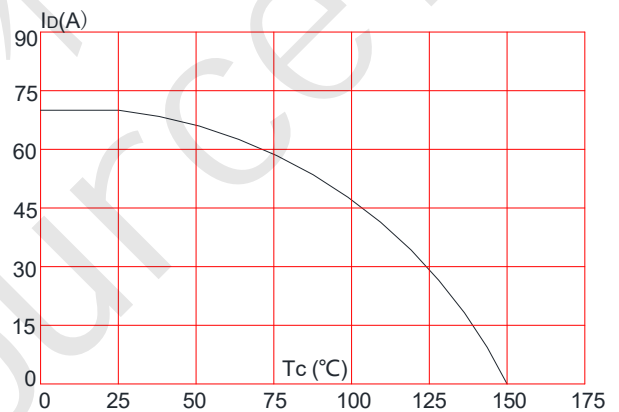

**Figure.11:** Maximum Effective Transient Thermal Impedance, Junction-to-Case

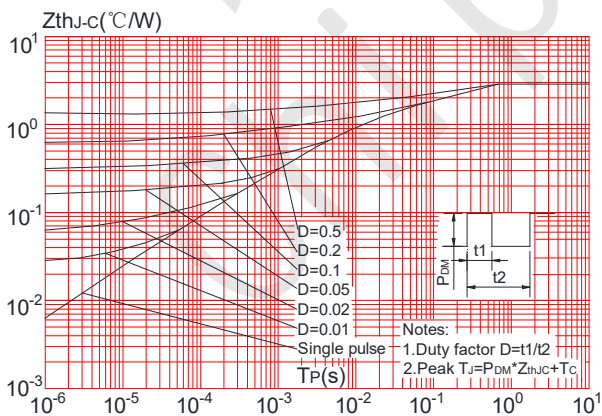



## CST80N03B N-Ch 30V Fast Switching MOSFETs

### CST80N03B Test Circuit

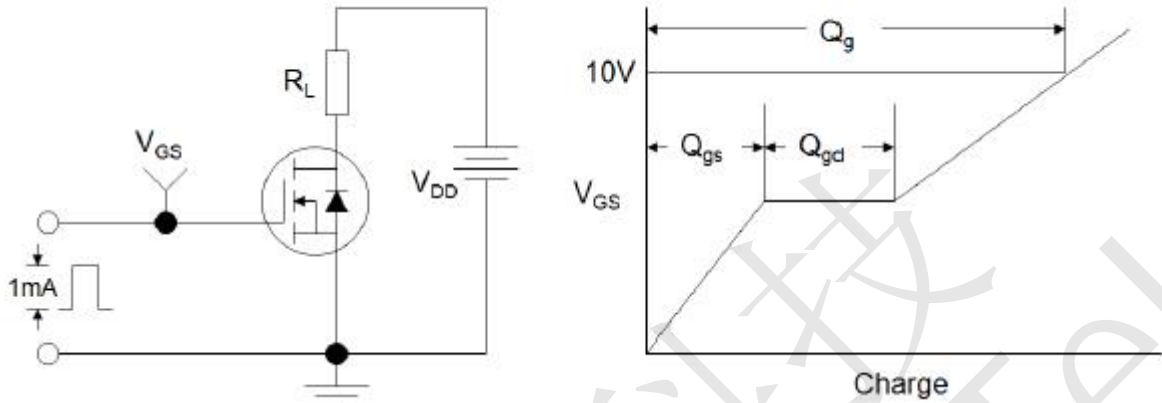

Figure1:Gate Charge Test Circuit & Waveform

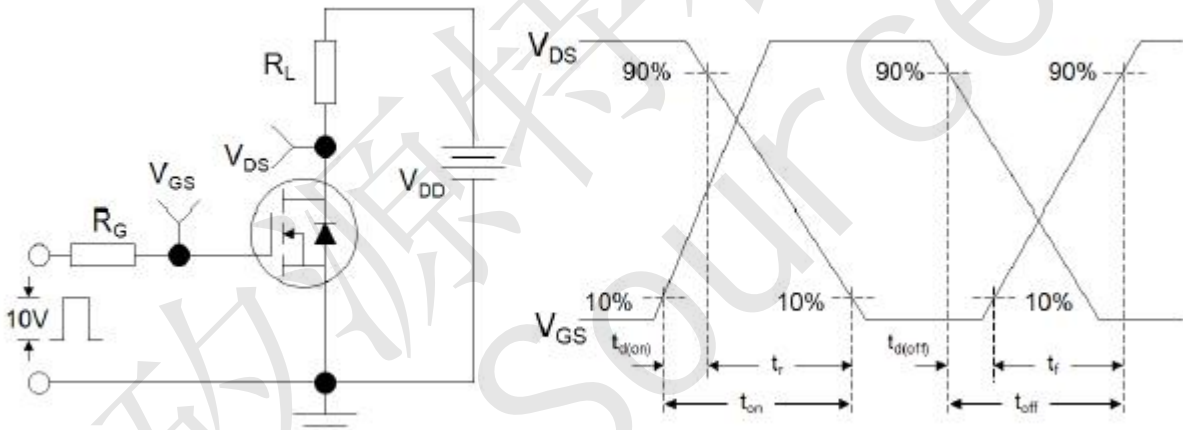

Figure 2: Resistive Switching Test Circuit & Waveforms

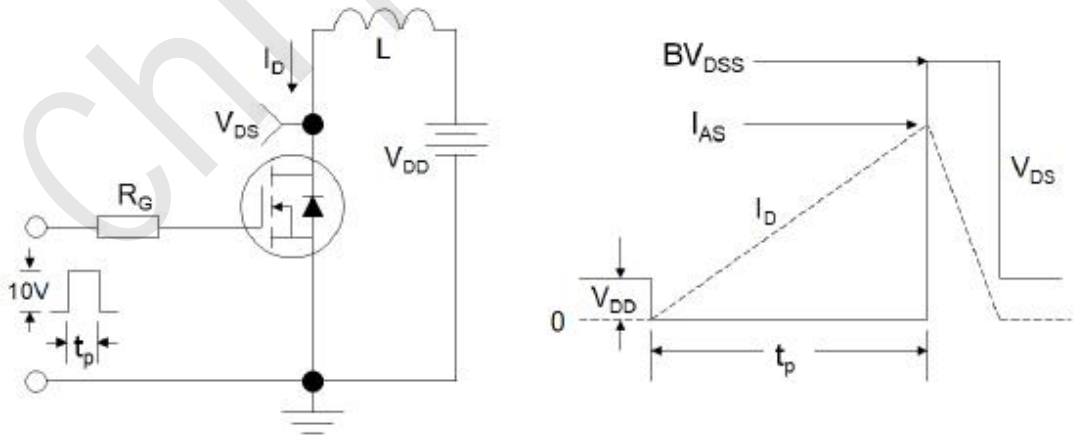

Figure 3:Unclamped Inductive Switching Test Circuit & Waveforms





### CST80N03B N-Ch 30V Fast Switching MOSFETs

#### CST80N03B Package Mechanical Data TO 252

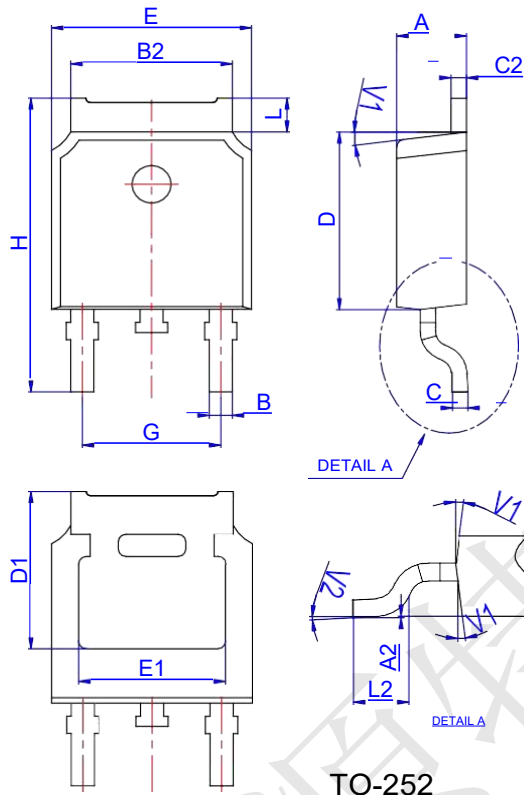

Ref.	Dimensions					
	Millimeters			Inches		
	Min.	Typ.	Max.	Min.	Typ.	Max.
A	2.10		2.50	0.083		0.098
A2	0		0.10	0		0.004
B	0.66		0.86	0.026		0.034
B2	5.18		5.48	0.202		0.216
C	0.40		0.60	0.016		0.024
C2	0.44		0.58	0.017		0.023
D	5.90		6.30	0.232		0.248
D1	5.30REF			0.209REF		
E	6.40		6.80	0.252		0.268
E1	4.63			0.182		
G	4.47		4.67	0.176		0.184
H	9.50		10.70	0.374		0.421
L	1.09		1.21	0.043		0.048
L2	1.35		1.65	0.053		0.065
V1		7°			7°	
V2	0°		6°	0°		6°

#### CST80N03B Reel Specification-TO-252

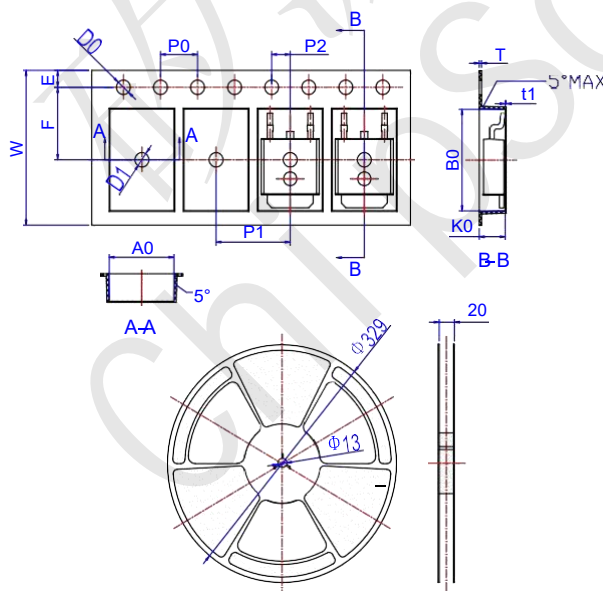

Ref.	Dimensions					
	Millimeters			Inches		
	Min.	Typ.	Max.	Min.	Typ.	Max.
W	15.90	16.00	16.10	0.626	0.630	0.634
E	1.65	1.75	1.85	0.065	0.069	0.073
F	7.40	7.50	7.60	0.291	0.295	0.299
D0	1.40	1.50	1.60	0.055	0.059	0.063
D1	1.40	1.50	1.60	0.055	0.059	0.063
P0	3.90	4.00	4.10	0.154	0.157	0.161
P1	7.90	8.00	8.10	0.311	0.315	0.319
P2	1.90	2.00	2.10	0.075	0.079	0.083
A0	6.85	6.90	7.00	0.270	0.271	0.276
B0	10.45	10.50	10.60	0.411	0.413	0.417
K0	2.68	2.78	2.88	0.105	0.109	0.113
T	0.24		0.27	0.009		0.011
t1	0.10			0.004		
10P0	39.80	40.00	40.20	1.567	1.575	1.583