



CST80N06F N-Ch 60V Fast Switching MOSFETs

- ★ Super Low Gate Charge
- ★ 100% EAS Guaranteed
- ★ Green Device Available
- ★ Excellent CdV/dt effect decline
- ★ Advanced high cell density Trench technology

CST80N06F Product Summary



BVDSS	RDSON	ID
60V	6 mΩ	80A

CST80N06F Description

The CST80N06F is the high cell density trenched N-ch MOSFETs, which provide excellent RDSON and gate charge for most of the synchronous buck converter applications.

The CST80N06F meet the RoHS and Green Product requirement 100% EAS guaranteed with full function reliability approved.

CST80N06F PDFN5060-8L Pin Configuration

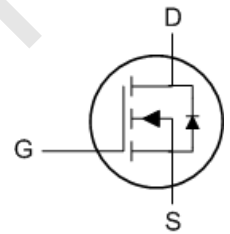
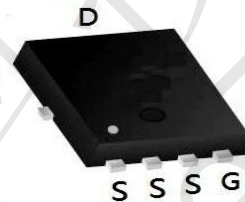

CST80N06F Absolute Maximum Ratings (T_c=25°C unless otherwise specified)

Symbol	Parameter	Max.	Units
V _{DSS}	Drain-Source Voltage	60	V
V _{GSS}	Gate-Source Voltage	±25	V
I _D	Continuous Drain Current	T _c = 25°C	80
		T _c = 100°C	52
I _{DM}	Pulsed Drain Current ^{note1}	320	A
EAS	Single Pulsed Avalanche Energy ^{note2}	169	mJ
P _D	Power Dissipation	T _c = 25°C	108
R _{θJC}	Thermal Resistance, Junction to Case	1.4	°C/W
T _J , T _{STG}	Operating and Storage Temperature Range	-55 to +175	°C



CST80N06F N-Ch 60V Fast Switching MOSFETs

CST80N06F Electrical Characteristics (T_J=25°C unless otherwise specified)

Symbol	Parameter	Test Condition	Min.	Typ.	Max.	Units
Off Characteristic						
V _{(BR)DSS}	Drain-Source Breakdown Voltage	V _{GS} =0V, I _D =250μA	60	-	-	V
I _{DSS}	Zero Gate Voltage Drain Current	V _{DS} =60V, V _{GS} =0V,	-	-	1.0	μA
I _{GSS}	Gate to Body Leakage Current	V _{DS} =0V, V _{GS} =±20V	-	-	±100	nA
On Characteristics						
V _{GS(th)}	Gate Threshold Voltage	V _{DS} =V _{GS} , I _D =250μA	2	3	4	V
R _{DS(on)}	Static Drain-Source on-Resistance note3	V _{GS} =10V, I _D = 30A	-	6	7	mΩ
Dynamic Characteristics						
C _{iss}	Input Capacitance	V _{DS} =30V, V _{GS} =0V, f=1.0MHz	-	4136	-	pF
C _{oss}	Output Capacitance		-	286	-	pF
C _{rss}	Reverse Transfer Capacitance		-	257	-	pF
Q _g	Total Gate Charge	V _{DS} =30V, I _D =30A, V _{GS} =10V	-	90	-	nC
Q _{gs}	Gate-Source Charge		-	9	-	nC
Q _{gd}	Gate-Drain("Miller") Charge		-	18	-	nC
Switching Characteristics						
t _{d(on)}	Turn-on Delay Time	V _{DS} =30V, I _D =30A, R _G =1.8Ω, V _{GS} =10V	-	9	-	ns
t _r	Turn-on Rise Time		-	7	-	ns
t _{d(off)}	Turn-off Delay Time		-	40	-	ns
t _f	Turn-off Fall Time		-	15	-	ns
Drain-Source Diode Characteristics and Maximum Ratings						
I _S	Maximum Continuous Drain to Source Diode Forward Current		-	-	80	A
I _{SM}	Maximum Pulsed Drain to Source Diode Forward Current		-	-	320	A
V _{SD}	Drain to Source Diode Forward Voltage	V _{GS} =0V, I _S =30A	-	-	1.2	V
t _{rr}	Body Diode Reverse Recovery Time	I _F =30A, di/dt=100A/μs	-	33	-	ns
Q _{rr}	Body Diode Reverse Recovery Charge		-	46	-	nC

Notes:1. Repetitive Rating: Pulse Width Limited by Maximum Junction Temperature

2. EAS condition : T_J=25°C, V_{DD}=30V, V_G=10V, L=0.5mH, R_g=25Ω, I_{AS}=26A

3. Pulse Test: Pulse Width≤300μs, Duty Cycle≤0.5%



CST80N06F Typical Performance Characteristics

Figure 1: Output Characteristics

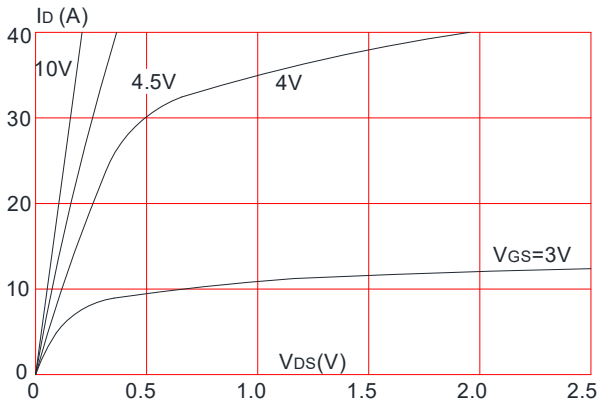

Figure 2: Typical Transfer Characteristics

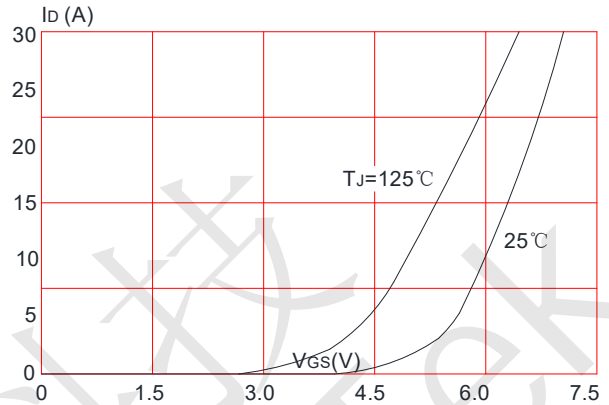

Figure 3: On-resistance vs. Drain Current

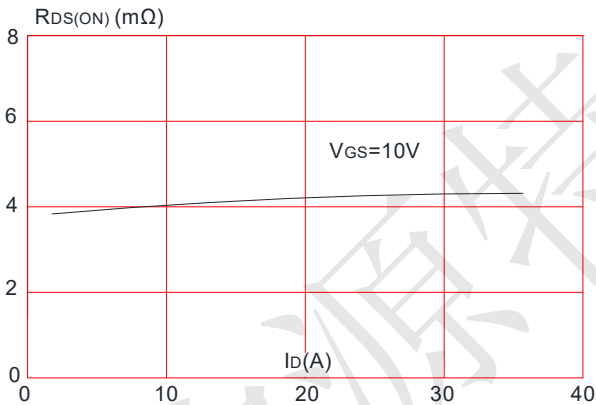

Figure 4: Body Diode Characteristics

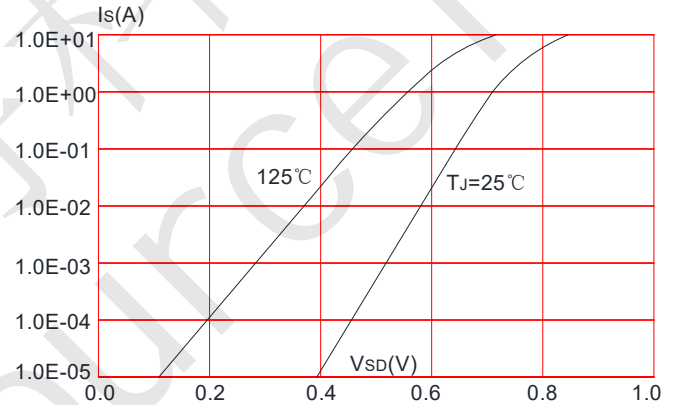

Figure 5: Gate Charge Characteristics

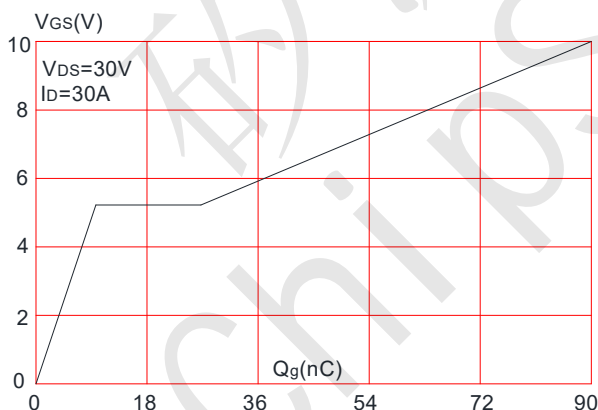
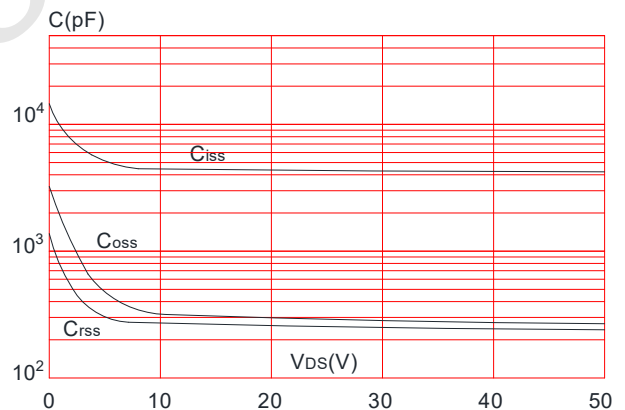

Figure 6: Capacitance Characteristics





CST80N06F N-Ch 60V Fast Switching MOSFETs

Figure 7: Normalized Breakdown Voltage vs. Junction Temperature

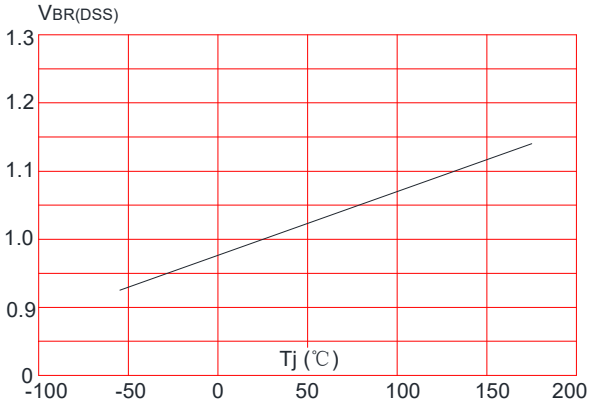

Figure 8: Normalized on Resistance vs. Junction Temperature

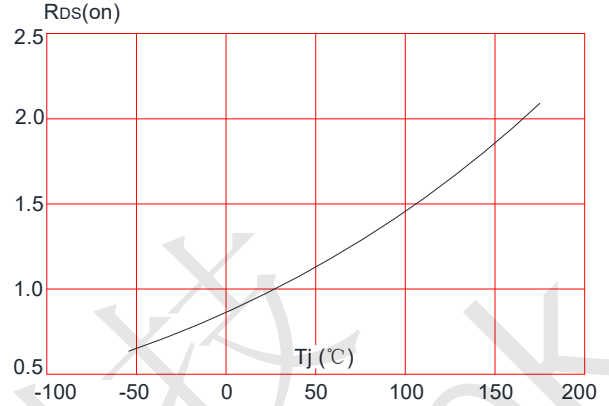

Figure 9: Maximum Safe Operating Area

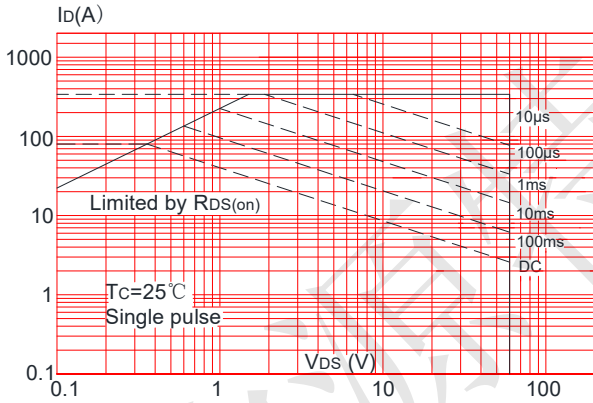

Figure 10: Maximum Continuous Drain Current vs. Case Temperature

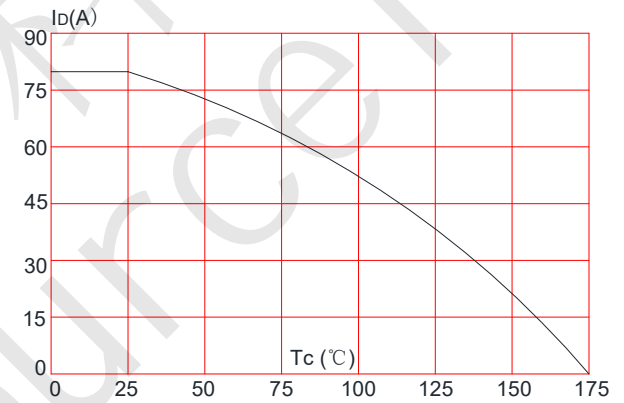
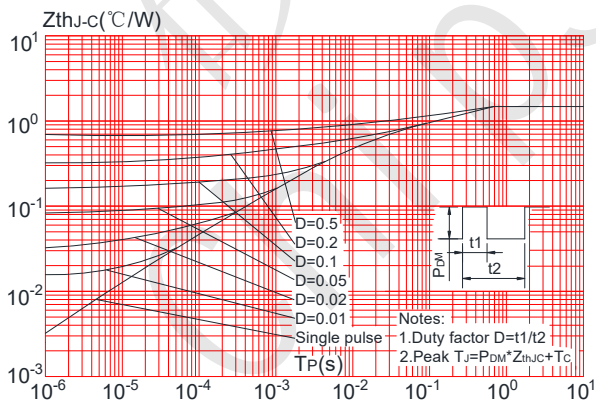
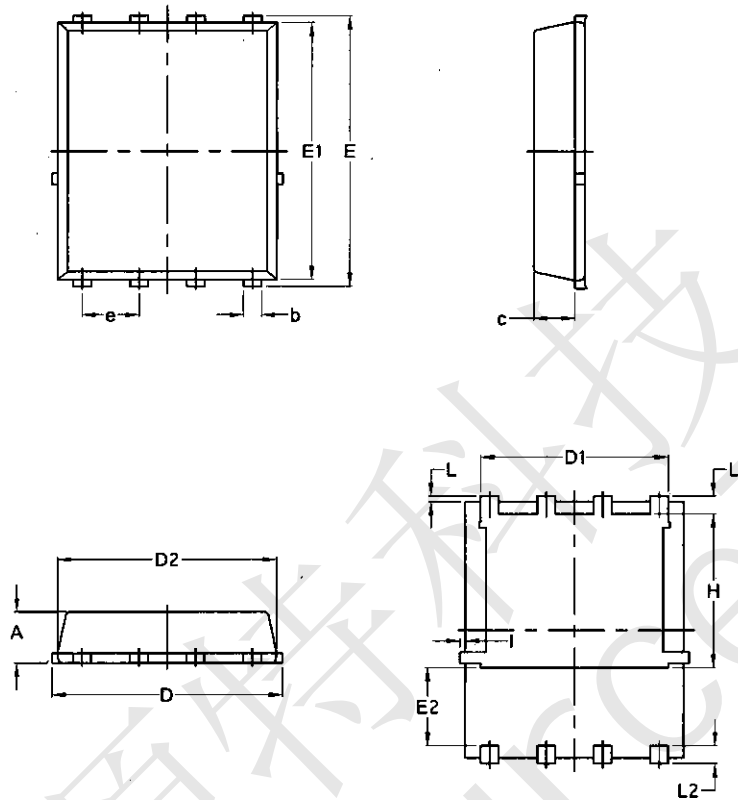

Figure.11: Maximum Effective Transient Thermal Impedance, Junction-to-Case





CST80N06F Package Mechanical Data PDFN5060-8L- Single



Symbol	Common			
	mm		Inch	
	Min	Max	Min	Max
A	1.03	1.17	0.0406	0.0461
b	0.34	0.48	0.0134	0.0189
c	0.824	0.0970	0.0324	0.082
D	4.80	5.40	0.1890	0.2126
D1	4.11	4.31	0.1618	0.1697
D2	4.80	5.00	0.1890	0.1969
E	5.95	6.15	0.2343	0.2421
E1	5.65	5.85	0.2224	0.2303
E2	1.60	/	0.0630	/
e	1.27 BSC		0.05 BSC	
L	0.05	0.25	0.0020	0.0098
L1	0.38	0.50	0.0150	0.0197
L2	0.38	0.50	0.0150	0.0197
H	3.30	3.50	0.1299	0.1378
I	/	0.18	/	0.0070