



CSTS260N10G N-Ch 100V Fast Switching MOSFETs

CSTS260N10G Features

- Split Gate Trench MOSFET technology
- Excellent package for heat dissipation
- High density cell design for low $R_{DS(ON)}$

CSTS260N10G Product Summary



BVDSS	R _{DS(on)}	I _D
100V	2.4 mΩ	260A

CSTS260N10G Applications

- DC-DC Converters
- Power management functions
- Synchronous-rectification applications

CSTS260N10G TO-263 Pin Configuration

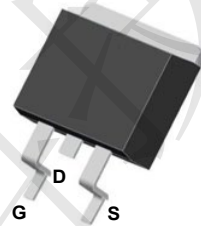

TO-263

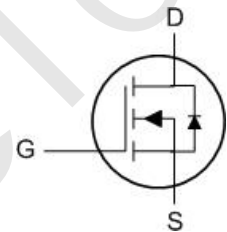

CSTS260N10G Absolute Maximum Ratings (TA = 25°C, unless otherwise noted)

Parameter	Symbol	Value	Unit
Drain-Source Voltage	V _{DS}	100	V
Gate-Source Voltage	V _{GS}	±20	V
Continuous Drain Current	I _D	T _C =25°C	260
		T _C =100°C	163
Pulsed Drain Current ¹	I _{DM}	1028	A
Single Pulse Avalanche Energy ²	E _{AS}	583	mJ
Total Power Dissipation	P _D	379	W
Operating Junction and Storage Temperature Range	T _J , T _{STG}	-55 to 150	°C

CSTS260N10G Thermal Characteristics

Parameter	Symbol	Value	Unit
Thermal Resistance from Junction-to-Ambient ³	R _{θJA}	59	°C/W



CSTS260N10G N-Ch 100V Fast Switching MOSFETs

CSTS260N10G Electrical Characteristics (T_J = 25°C, unless otherwise noted)

Parameter	Symbol	Test Conditions	Min.	Typ.	Max.	Unit	
Static Characteristics							
Drain-Source Breakdown Voltage	V _{(BR)DSS}	V _{GS} = 0V, I _D = 250μA	100	-	-	V	
Gate-body Leakage current	I _{GSS}	V _{DS} = 0V, V _{GS} = ±20V	-	-	±100	nA	
Zero Gate Voltage Drain Current	I _{DSS}	V _{DS} = 100V, V _{GS} = 0V	T _J = 25°C	-	-	1	μA
			T _J = 100°C	-	-	100	
Gate-Threshold Voltage	V _{GS(th)}	V _{DS} = V _{GS} , I _D = 250μA	2	3	4	V	
Drain-Source on-Resistance ⁴	R _{DS(on)}	V _{GS} = 10V, I _D = 20A	-	2.4	2.8	mΩ	
Forward Transconductance ⁴	g _{fs}	V _{DS} = 10V, I _D = 20A	-	76	-	S	
Dynamic Characteristics⁵							
Input Capacitance	C _{iss}	V _{DS} = 50V, V _{GS} = 0V, f = 1MHz	-	9030	-	pF	
Output Capacitance	C _{oss}		-	1505	-		
Reverse Transfer Capacitance	C _{rss}		-	40	-		
Gate Resistance	R _g	f = 1MHz	-	2.3	-	Ω	
Switching Characteristics⁵							
Total Gate Charge	Q _g	V _{GS} = 10V, V _{DS} = 50V, I _D = 20A	-	150	-	nC	
Gate-Source Charge	Q _{gs}		-	32.5	-		
Gate-Drain Charge	Q _{gd}		-	49	-		
Turn-on Delay Time	t _{d(on)}	V _{GS} = 10V, V _{DD} = 50V, R _G = 3Ω, I _D = 20A	-	27	-	ns	
Rise Time	t _r		-	78.5	-		
Turn-off Delay Time	t _{d(off)}		-	110	-		
Fall Time	t _f		-	86	-		
Body Diode Reverse Recovery Time	t _{rr}	I _F = 20A, di/dt = 100A/μs	-	88	-	ns	
Body Diode Reverse Recovery Charge	Q _{rr}		-	220	-	nC	
Drain-Source Body Diode Characteristics							
Diode Forward Voltage ⁴	V _{SD}	I _D = 20A, V _{GS} = 0V	-	-	1.2	V	
Continuous Source Current	I _S	T _C = 25°C	-	-	260	A	

Notes:

1. Repetitive rating, pulse width limited by junction temperature T_{J(MAX)} = 150°C.
2. The EAS data shows Max. rating. The test condition is V_{DD} = 50V, V_{GS} = 10V, L = 0.4mH, I_{AS} = 54A.
3. The data tested by surface mounted on a 1 inch² FR-4 board with 2OZ copper, The value in any given application depends on the user's specific board design.
4. The data tested by pulsed, pulse width ≤ 300us, duty cycle ≤ 2%.
5. This value is guaranteed by design hence it is not included in the production test.



CSTS260N10G Typical Characteristics

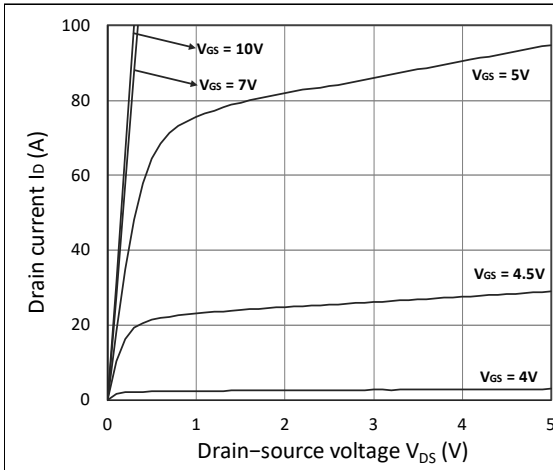

Figure 1. Output Characteristics

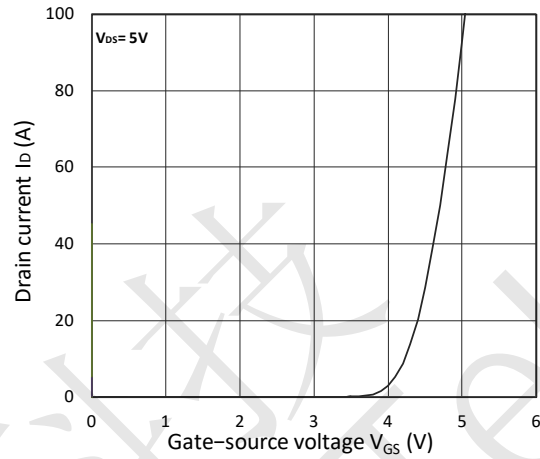

Figure 2. Transfer Characteristics

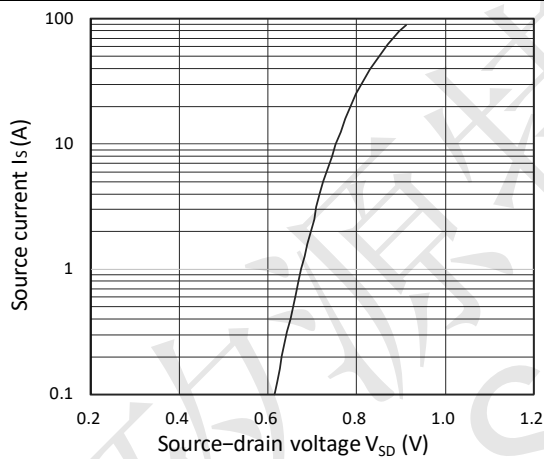

Figure 3. Forward Characteristics of Reverse

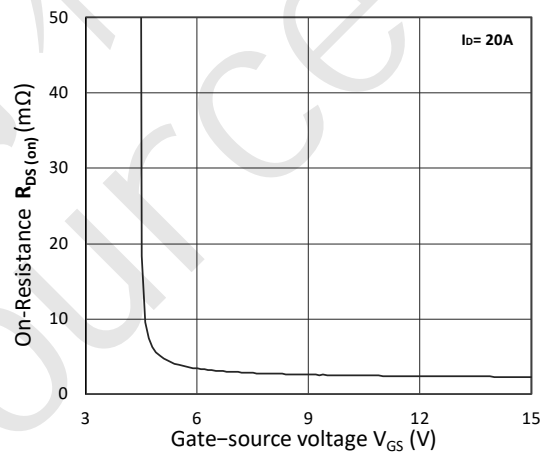

Figure 4. $R_{DS(on)}$ vs. V_{GS}

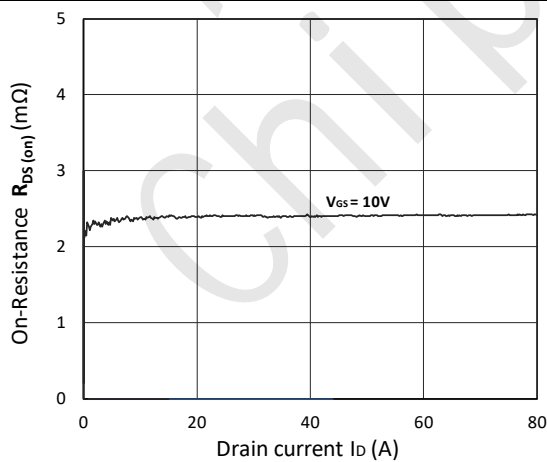

Figure 5. $R_{DS(on)}$ vs. I_D

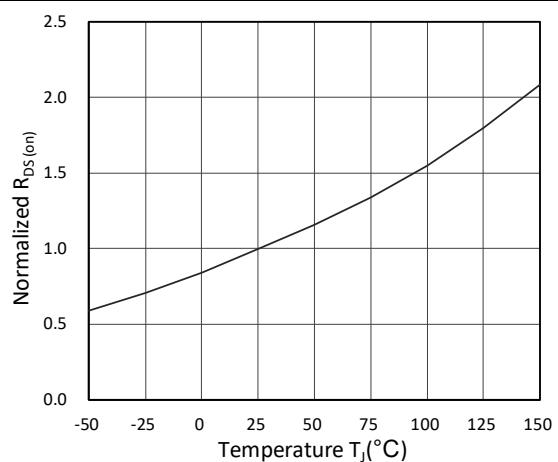

Figure 6. Normalized $R_{DS(on)}$ vs. Temperature



CSTS260N10G N-Ch 100V Fast Switching MOSFETs

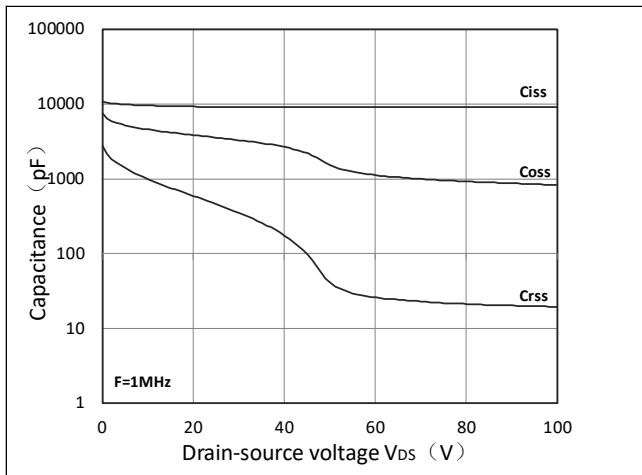

Figure 7. Capacitance Characteristics

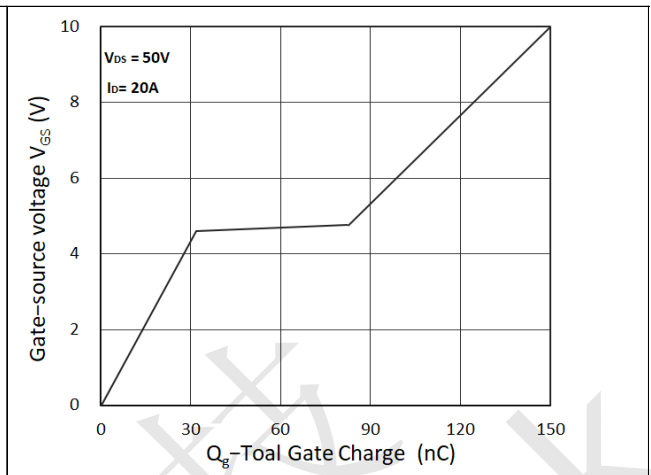

Figure 8. Gate Charge Characteristics

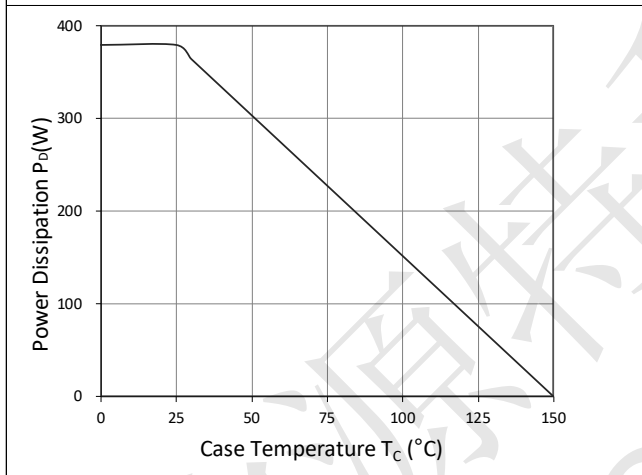

Figure 9. Power Dissipation

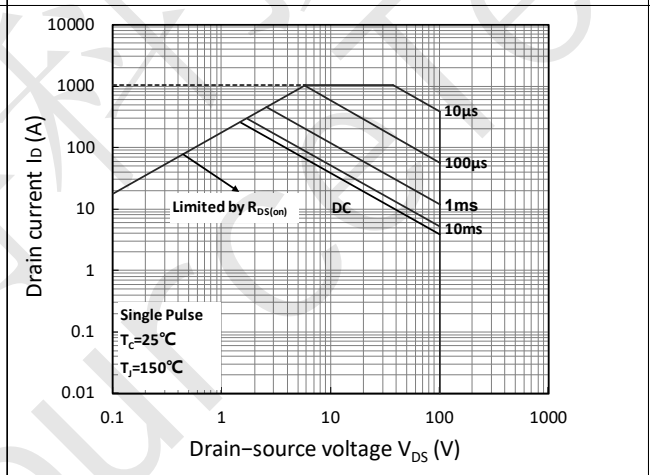

Figure 10. Safe Operating Area

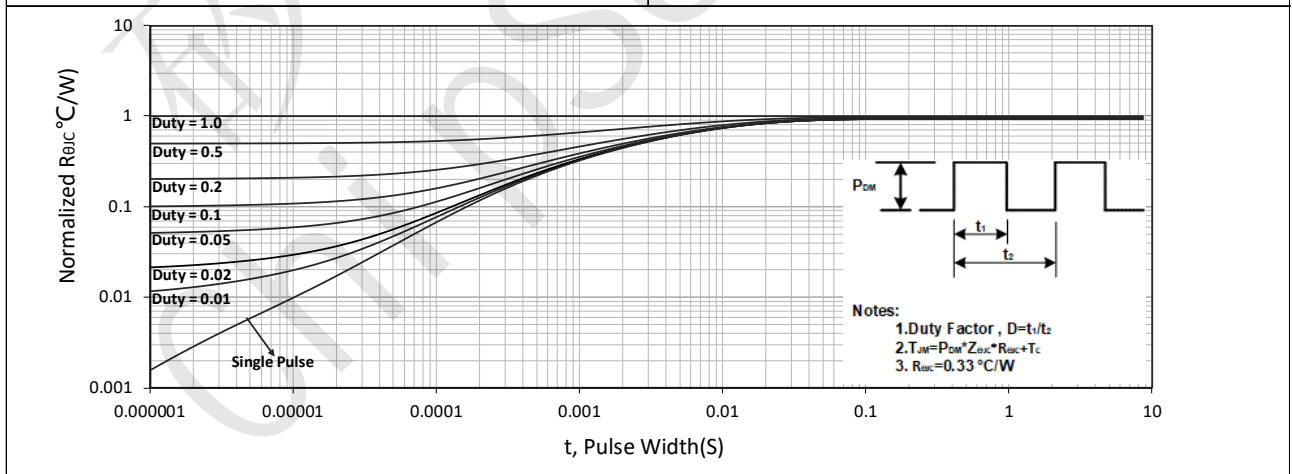

Figure 11. Normalized Maximum Transient Thermal Impedance



CSTS260N10G Test Circuit

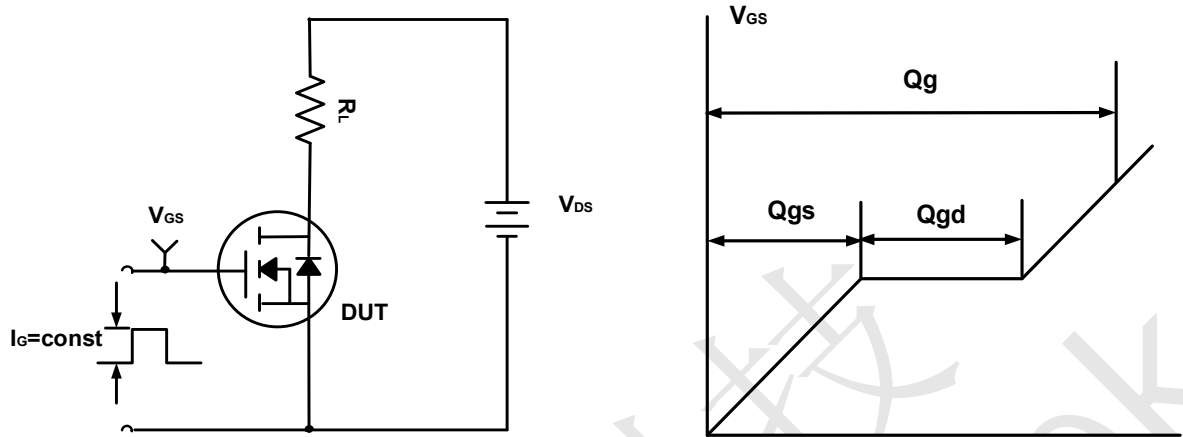

Figure A. Gate Charge Test Circuit & Waveforms

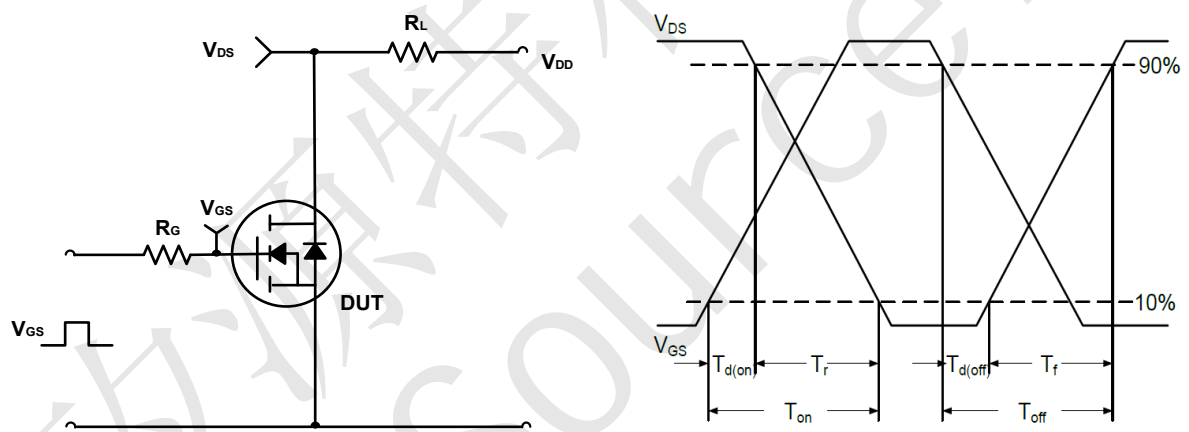
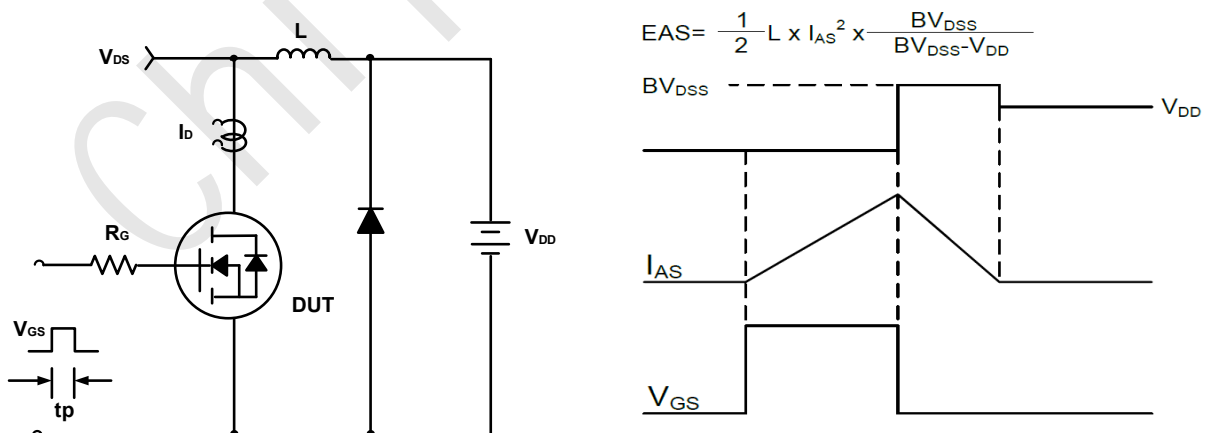

Figure B. Switching Test Circuit & Waveforms





CSTS260N10G Mechanical Dimensions for TO-263

COMMON DIMENSIONS

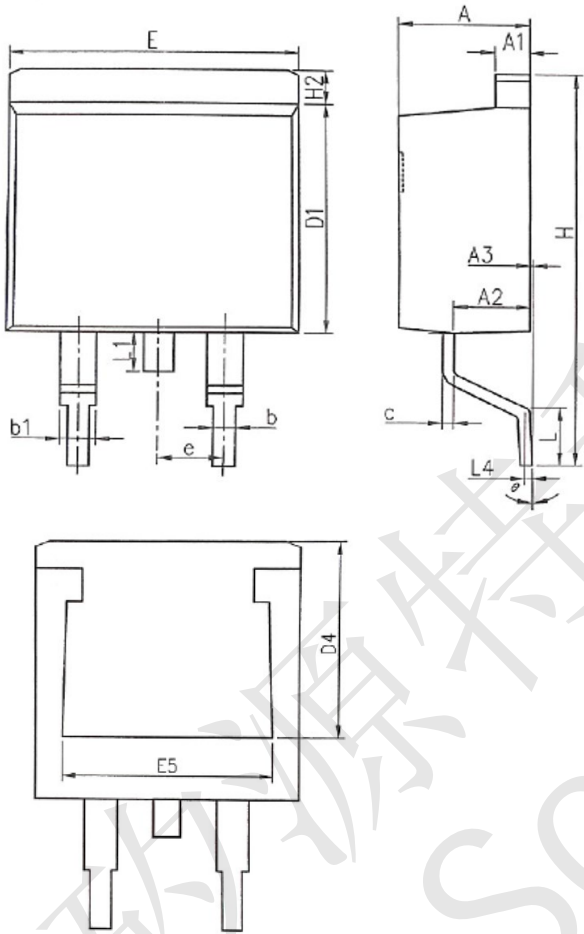

SYMBOL	MM	
	MIN	MAX
A	4.37	4.89
A1	1.17	1.42
A2	2.20	2.90
A3	0.00	0.25
b	0.70	0.96
b1	1.17	1.47
c	0.28	0.60
D1	8.45	9.30
D4	6.60	-
E	9.80	10.40
E5	7.06	-
e	2.54BSC	
H	14.70	15.70
H2	1.07	1.47
L	2.00	2.80
L1	-	1.75
L4	0.254BSC	
θ	0°	9°