



## MOT120N03D/C N-CHANNEL MOSFET

### ■ MOT120N03D/C PRODUCT CHARACTERISTICS

VDSS	30V
$R_{DS(on)Typ}(@V_{GS} = 10\text{ V})$	3m $\Omega$
ID	120A

### Symbol

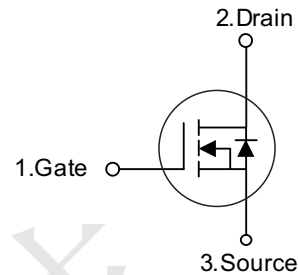

### ■ MOT120N03D/C APPLICATIONS

- \* Power switching application
- \* Hard switched and high frequency circuits
- \* Uninterruptible power supply

### ■ MOT120N03D/C FEATURES

- \* High density cell design for ultra low  $R_{DS(on)}$
- \* Excellent package for good heat DISSIPATION



### ■ MOT120N03D/C ORDER INFORMATION

Order codes		Package	Packing
Halogen-Free	Halogen		
N/A	MOT120N03D	TO-252	2500 pieces /Reel
N/A	MOT120N03C	TO-251	70 pieces/Tube

### ■ MOT120N03D/C ABSOLUTE MAXIMUM RATINGS ( $T_C = 25^\circ\text{C}$ , unless otherwise specified)

Parameter	Symbol	Value	Unit
Drain-Source Voltage	$V_{DS}$	30	V
Gate-Source Voltage	$V_{GS}$	$\pm 20$	V
Drain Current-Continuous	$I_D$	120	A
Drain Current-Continuous( $T_C=100^\circ\text{C}$ )	$I_D(100^\circ\text{C})$	84	A
Pulsed Drain Current	$I_{DM}$	420	A
Maximum Power Dissipation	$P_D$	120	W
Single pulse avalanche energy <sup>(Note 5)</sup>	$E_{AS}$	350	mJ
Operating Junction and Storage Temperature Range	$T_J, T_{STG}$	-55 To 175	$^\circ\text{C}$

### ■ MOT120N03D/C THERMAL DATA

Parameter	Symbol	Value	Unit
Thermal Resistance, Junction-to-Case <sup>(Note 2)</sup>	$R_{\theta JC}$	1.25	$^\circ\text{C/W}$



### MOT120N03D/C N-CHANNEL MOSFET

■ MOT120N03D/C ELECTRICAL CHARACTERISTICS (T<sub>C</sub>=25°C, unless otherwise noted)

Parameter	Symbol	Condition	Min	Typ	Max	Unit
<b>Off Characteristics</b>						
Drain-Source Breakdown Voltage	BV <sub>DSS</sub>	V <sub>GS</sub> =0V, I <sub>D</sub> =250μA	30	-	-	V
Zero Gate Voltage Drain Current	I <sub>DSS</sub>	V <sub>DS</sub> =30V, V <sub>GS</sub> =0V	-	-	1	μA
Gate-Body Leakage Current	I <sub>GSS</sub>	V <sub>GS</sub> =±20V, V <sub>DS</sub> =0V	-	-	±100	nA
<b>On Characteristics</b> (Note 3)						
Gate Threshold Voltage	V <sub>GS(th)</sub>	V <sub>DS</sub> =V <sub>GS</sub> , I <sub>D</sub> =250μA	1	1.6	3	V
Drain-Source On-State Resistance	R <sub>DS(ON)</sub>	V <sub>GS</sub> =10V, I <sub>D</sub> =20A	-	3	3.5	mΩ
Gate resistance	R <sub>G</sub>	F=1.0MHz	-	1.2	-	Ω
Forward Transconductance	g <sub>FS</sub>	V <sub>DS</sub> =10V, I <sub>D</sub> =20A	50	-	-	S
<b>Dynamic Characteristics</b> (Note 4)						
Input Capacitance	C <sub>iss</sub>	V <sub>DS</sub> =25V, V <sub>GS</sub> =0V, F=1.0MHz	-	4120	-	PF
Output Capacitance	C <sub>oss</sub>		-	498	-	PF
Reverse Transfer Capacitance	C <sub>rss</sub>		-	456	-	PF
<b>Switching Characteristics</b> (Note 4)						
Turn-on Delay Time	t <sub>d(on)</sub>	V <sub>GS</sub> =10V, V <sub>DS</sub> =20V R <sub>L</sub> =0.75Ω, R <sub>GEN</sub> =3Ω	-	11	-	nS
Turn-on Rise Time	t <sub>r</sub>		-	10	-	nS
Turn-Off Delay Time	t <sub>d(off)</sub>		-	38	-	nS
Turn-Off Fall Time	t <sub>f</sub>		-	11	-	nS
Total Gate Charge	Q <sub>g</sub>	V <sub>GS</sub> =10V, V <sub>DS</sub> =15V, I <sub>D</sub> =20A	-	79	-	nC
Gate-Source Charge	Q <sub>gs</sub>		-	9	-	nC
Gate-Drain Charge	Q <sub>gd</sub>		-	18	-	nC
<b>Drain-Source Diode Characteristics</b>						
Diode Forward Voltage	V <sub>SD</sub>	V <sub>GS</sub> =0V, I <sub>S</sub> =20A	-	-	1.2	V
Diode Forward Current	I <sub>S</sub>	-	-	-	120	A
Reverse Recovery Time	t <sub>rr</sub>	T <sub>J</sub> = 25°C, I <sub>F</sub> =20A	-	58	-	nS
Reverse Recovery Charge	Q <sub>rr</sub>	di/dt = 100A/μs (Note 3)	-	115	-	nC
Forward Turn-On Time	t <sub>on</sub>	Intrinsic turn-on time is negligible (turn-on is dominated by LS+LD)				

#### Notes:

1. Repetitive Rating: Pulse width limited by maximum junction temperature.
2. Surface Mounted on FR4 Board, t ≤ 10 sec.
3. Pulse Test: Pulse Width ≤ 300μs, Duty Cycle ≤ 2%.
4. Guaranteed by design, not subject to production
5. EAS condition: T<sub>j</sub>=25°C, V<sub>DD</sub>=15V, V<sub>G</sub>=10V, L=0.5mH, R<sub>g</sub>=25Ω



### MOT120N03D/C N-CHANNEL MOSFET

#### ■ MOT120N03D/C TYPICAL CHARACTERISTICS

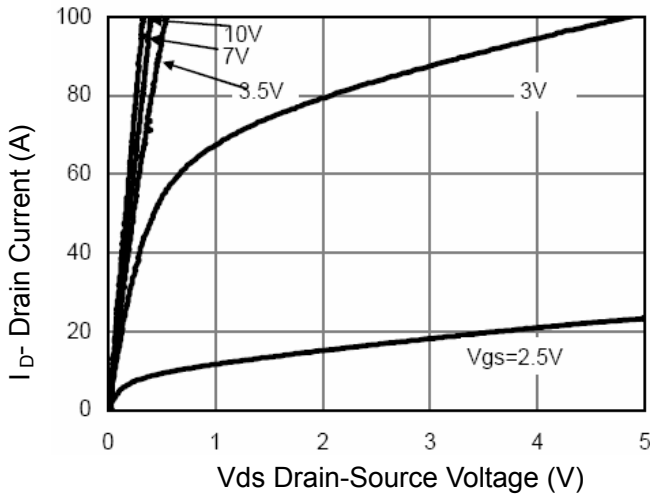

Figure 1 Output Characteristics

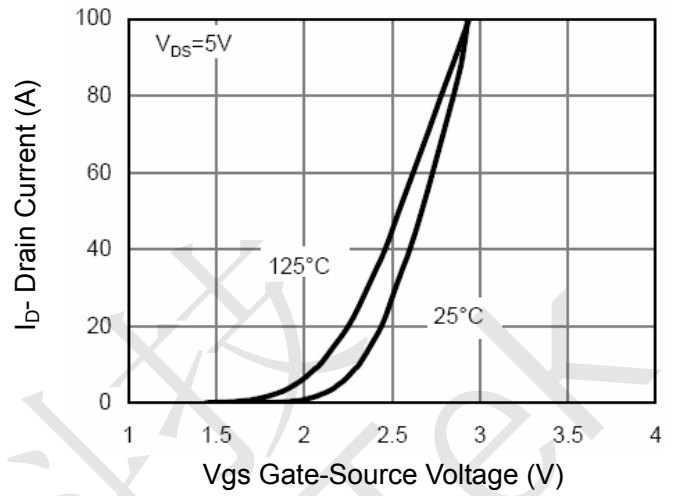

Figure 2 Transfer Characteristics

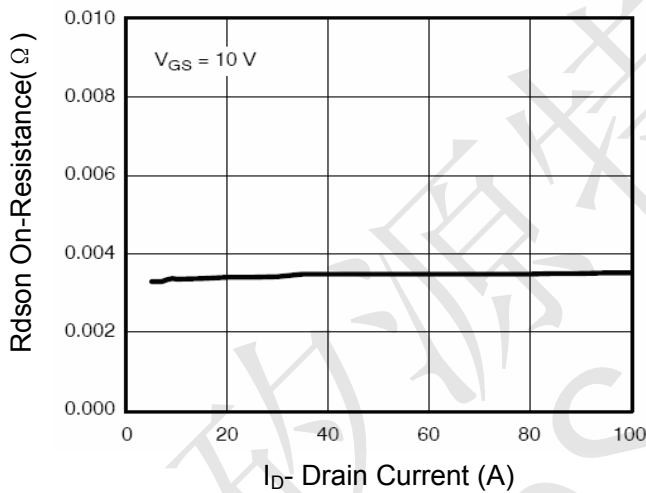

Figure 3  $R_{DS(on)}$ - Drain Current

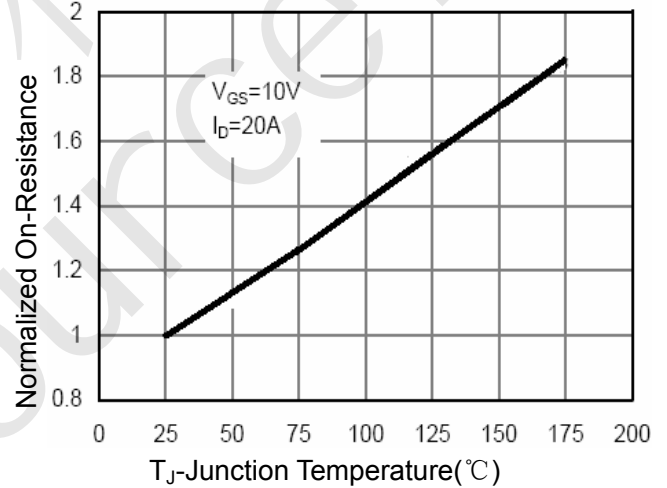

Figure 4  $R_{DS(on)}$ -Junction Temperature

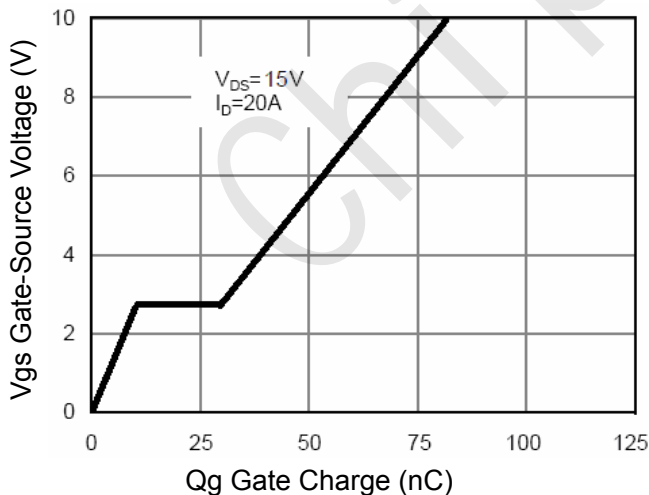

Figure 5 Gate Charge

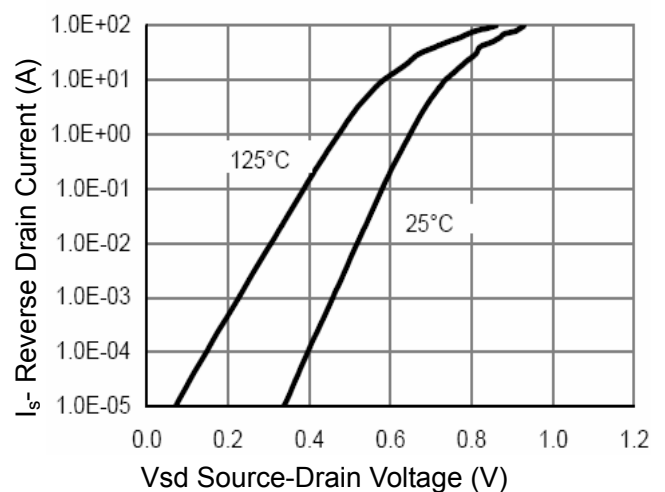
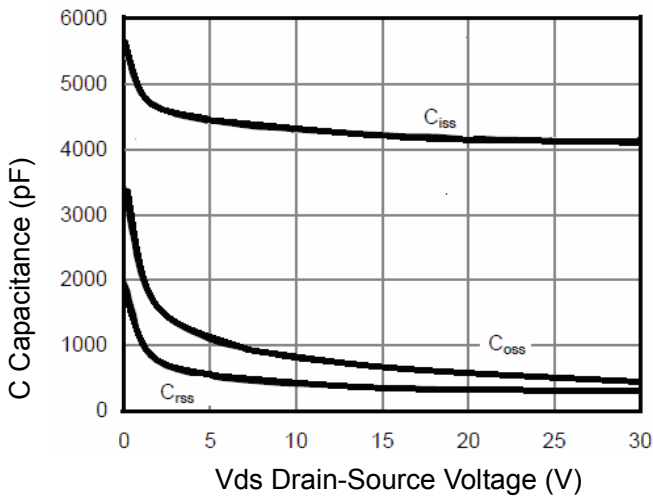

Figure 6 Source- Drain Diode Forward



### MOT120N03D/C N-CHANNEL MOSFET

#### ■ MOT120N03D/C TYPICAL CHARACTERISTICS(Cont.)



**Figure 7 Capacitance vs Vds**

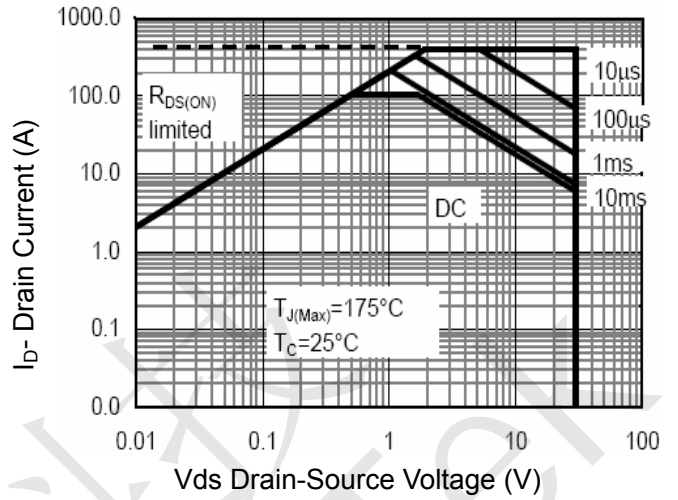

**Figure 8 Safe Operation Area**

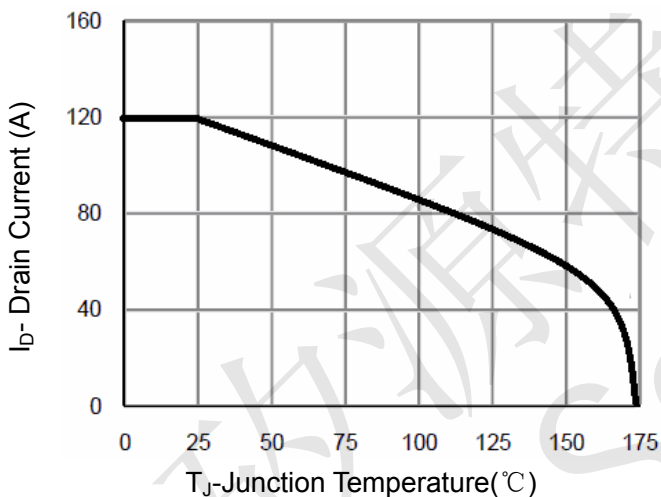

**Figure 9 Current De-rating**

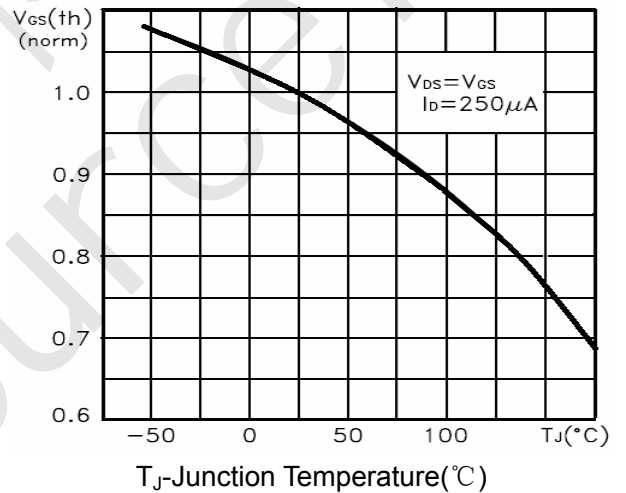

**Figure 10 V<sub>GS(th)</sub> vs Junction Temperature**

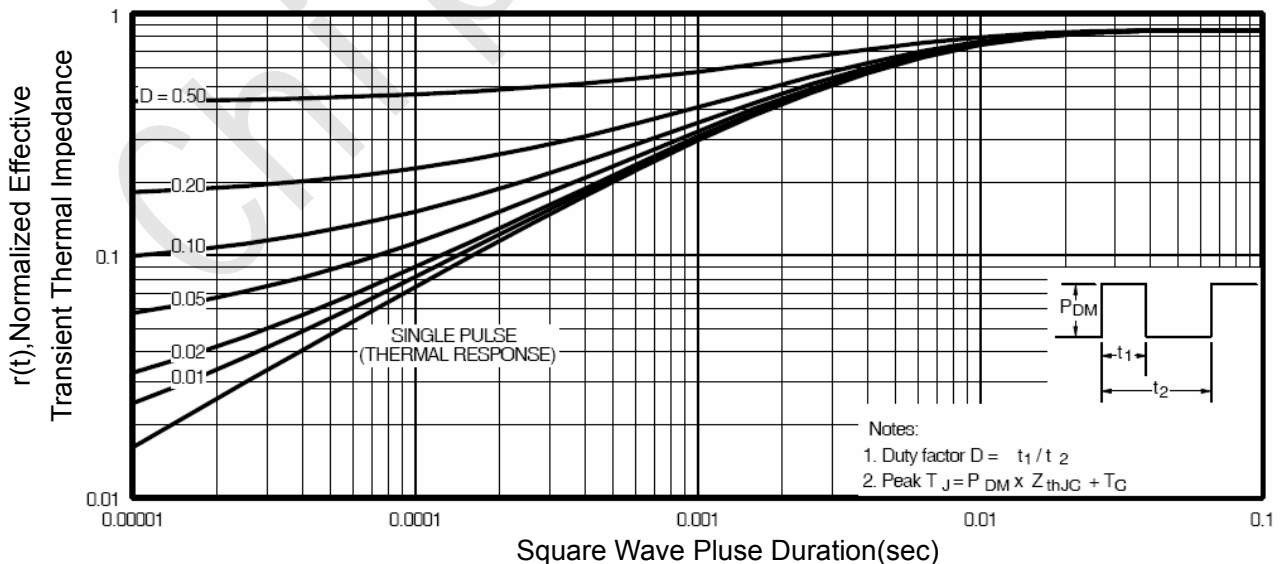
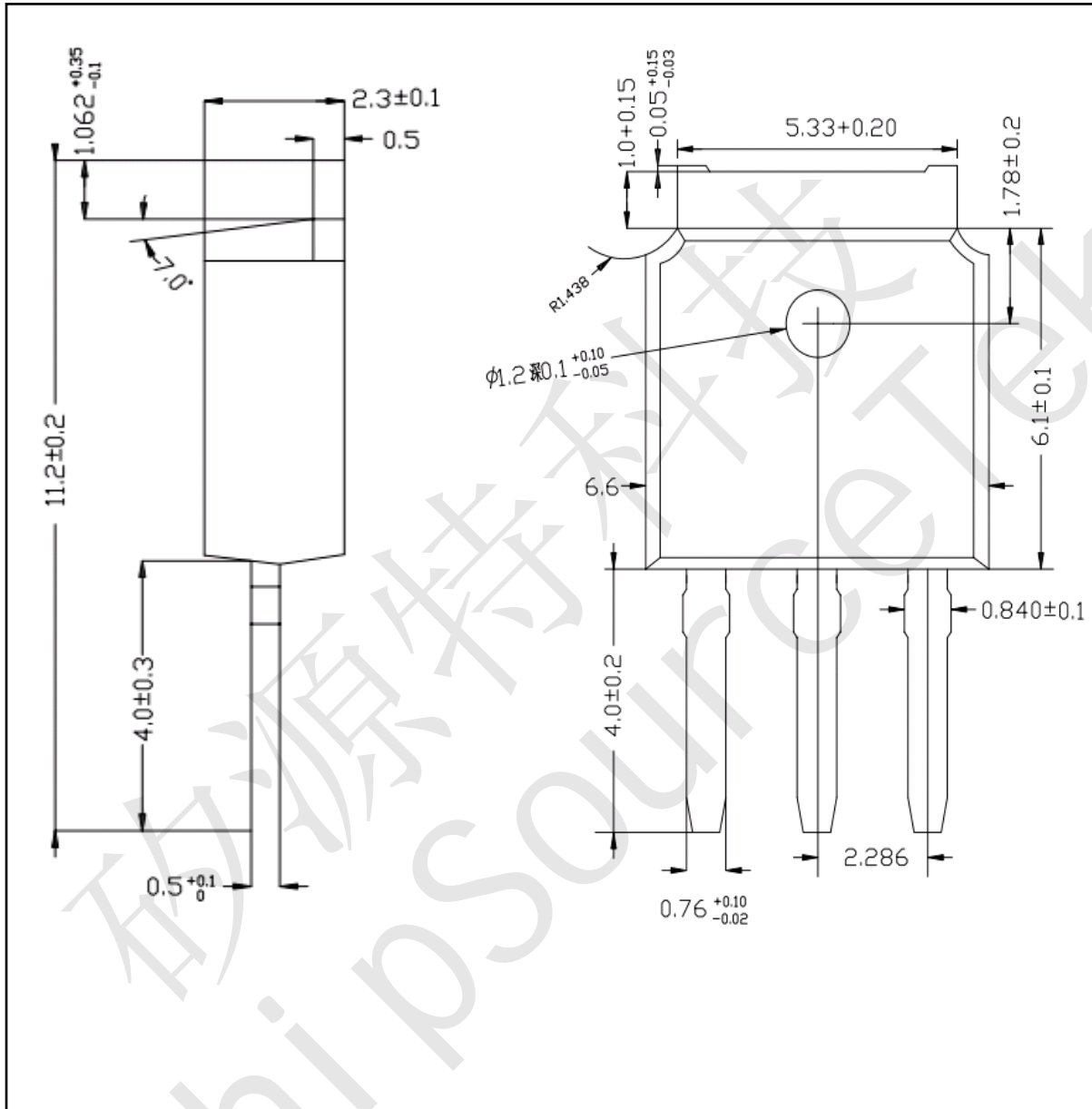

**Figure 11 Normalized Maximum Transient Thermal Impedance**



## MOT120N03D/C N-CHANNEL MOSFET

### ■ MOT120N03D/C TO-251-3L PACKAGE OUTLINE DIMENSIONS





## MOT120N03D/C N-CHANNEL MOSFET

### ■ MOT120N03D/C TO-252 PACKAGE OUTLINE DIMENSIONS

