



N-Channel Enhancement Mode Power MOSFET **MXD20N03**

DESCRIPTION

The MXD20N03 uses advanced trench technology to provide excellent $R_{DS(ON)}$, low gate charge and operation with gate voltages as low as 4.5V. This device is suitable for use as a wide variety of applications.

GENERAL FEATURES

- $V_{DS}=30V$, $I_D=20A$
 $R_{DS(ON)}(Typ.)=16m\Omega$ @ $V_{GS}=10V$
 $R_{DS(ON)}(Typ.)=28m\Omega$ @ $V_{GS}=4.5V$
- High Power and current handling capability
- Lead free product is acquired
- Surface Mount Package

APPLICATION

- PWM applications
- Load switch
- Power management

PINOUT

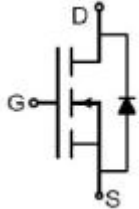

Schematic diagram

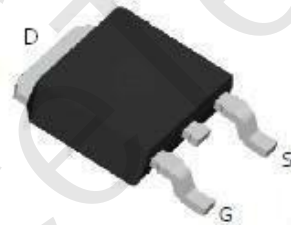

TO-252 top view

ORDERING INFORMATION

Device	Storage Temperature	Package	Devices Per Reel
MXD20N03	-55°C to 150°C	TO-252	2500

KEY PERFORMANCE PARAMETERS ($T_A=25^\circ C$ unless otherwise noted)

Parameter	Symbol	Value	Unit
Drain-Source Voltage ($V_{GS}=0V$)	V_{DS}	30	V
Gate-Source Voltage ($V_{DS}=0V$)	V_{GS}	± 20	V
Drain Current-Continuous ($T_C=25^\circ C$)	I_D	20	A
Drain Current-Continuous@Current-Pulsed ^(Note1)	$I_{DM(pluse)}$	10	A
Maximum Power Dissipation	P_D	7	W
Operating Junction and Storage Temperature Range	T_J, T_{STG}	-55 to 150	$^\circ C$

Notes 1.Repetitive Rating: Pulse width limited by maximum junction temperature

THERMAL CHARACTERISTIC

Parameter	Symbol	Value	Unit
Thermal Resistance, Junction-to-Ambient	$R_{\theta JA}$	85	$^\circ C/W$



ELECTRICAL CHARACTERISTICS ($T_A=25^\circ\text{C}$ unless otherwise noted)

Parameter	Symbol	Condition	Min	Typ	Max	Unit
-----------	--------	-----------	-----	-----	-----	------

On/Off Characteristics

Drain-Source Breakdown Voltage	BV_{DSS}	$V_{GS}=0V, I_D=250\mu A$	30	-	-	V
Zero Gate Voltage Drain Current	I_{DSS}	$V_{DS}=30V, V_{GS}=0V$	-	-	1	μA
Gate-Body Leakage Current	I_{GSS}	$V_{GS}=\pm 20V, V_{DS}=0V$	-	-	± 100	nA
Gate Threshold Voltage	$V_{GS(th)}$	$V_{DS}=V_{GS}, I_D=250\mu A$	1	1.5	2.5	V
Drain-Source On-State Resistance	$R_{DS(ON)}$	$V_{GS}=10V, I_D=5A$	-	16	22	m Ω
		$V_{GS}=4.5V, I_D=4A$	-	28	40	m Ω
Forward Transconductance	g_{FS}	$V_{DS}=5V, I_D=5A$	3	5.8	-	S

Dynamic Characteristics

Input Capacitance	C_{iss}	$V_{DS}=15V, V_{GS}=0V,$ $F=1.0\text{MHz}$	-	760	-	pF
Output Capacitance	C_{oss}		-	215	-	pF
Reverse Transfer Capacitance	C_{rss}		-	120	-	pF
Total Gate Charge	Q_g	$V_{DS}=10V, I_D=3.6A,$ $V_{GS}=5V$	-	7	-	nC
Gate-Source Charge	Q_{gs}		-	1.5	-	nC
Gate-Drain Charge	Q_{gd}		-	3	-	nC

Switching Characteristics

Turn-on Delay Time	$t_{d(on)}$	$V_{DD}=15V, I_D=5.5A,$ $R_L=15\Omega,$ $V_{GS}=10V, R_G=2.5\Omega$	-	10	-	nS
Turn-on Rise Time	t_r		-	4	-	nS
Turn-Off Delay Time	$t_{d(off)}$		-	27	-	nS
Turn-Off Fall Time	t_f		-	5	-	nS

Source-Drain Diode Characteristics

Source-Drain Current(Body Diode)	I_{SD}		-	-	30	A
Forward On Voltage	V_{SD}	$V_{GS}=0V, I_S=1A$	-	0.78	1.2	V



SWITCH TIME TEST CIRCUIT AND SWITCHING WAVEFORMS

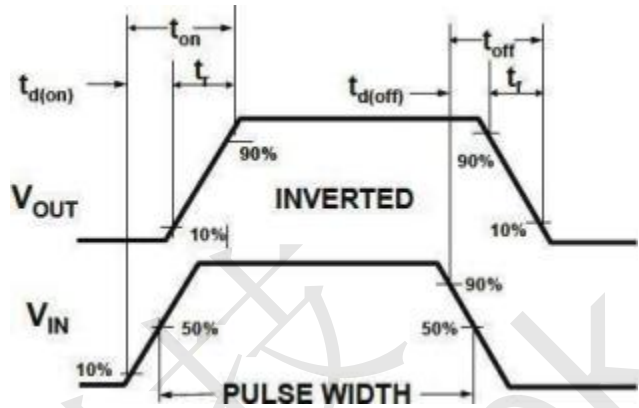
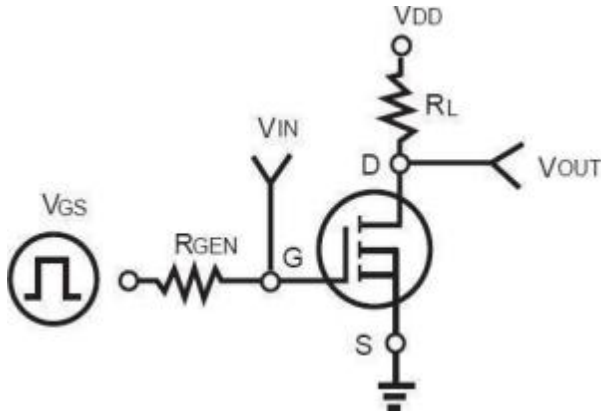

TYPICAL PERFORMANCE CHARACTERISTICS

Figure1. Power Dissipation

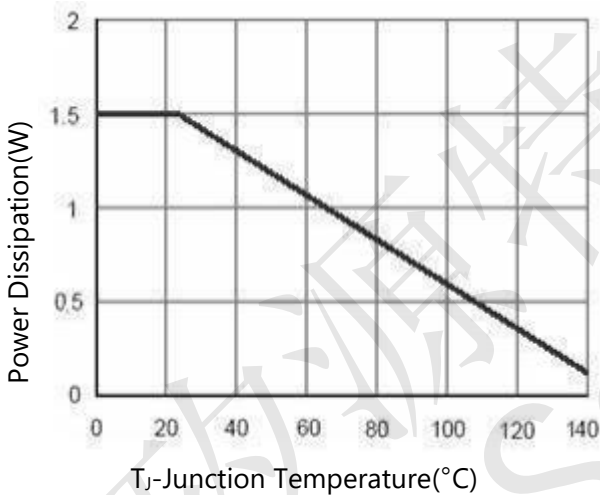

Figure2. Drain Current

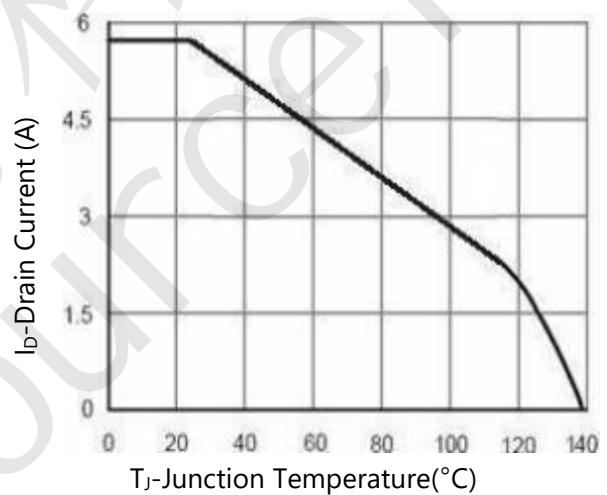

Figure3. Output Characteristics

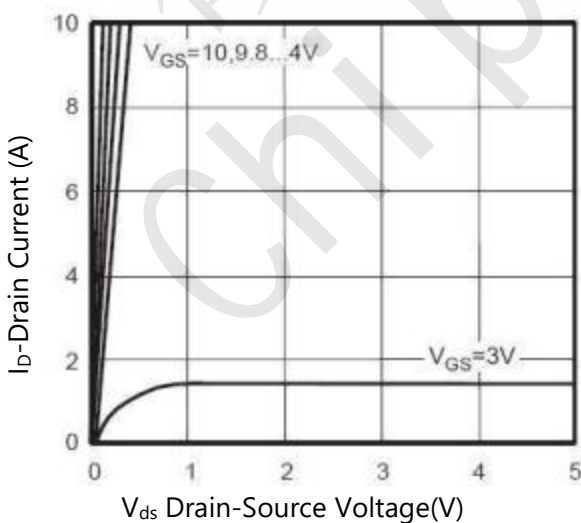
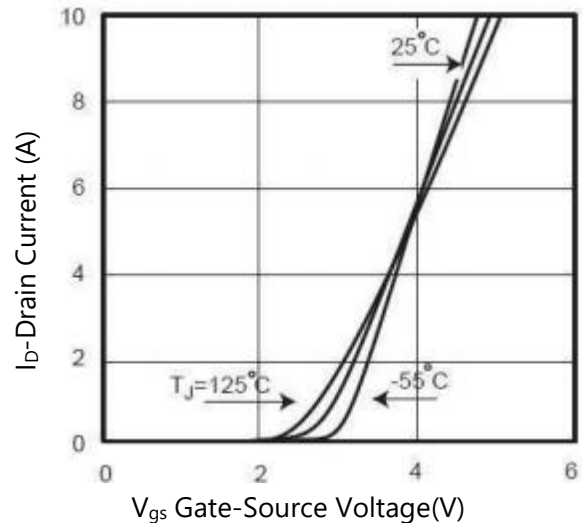

Figure4. Transfer Characteristics





TYPICAL PERFORMANCE CHARACTERISTICS

Figure5. Capacitance

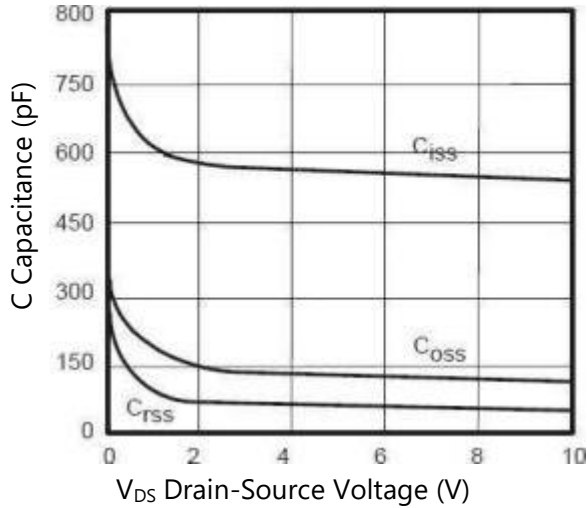

Figure6. $R_{DS(ON)}$ vs Junction Temperature

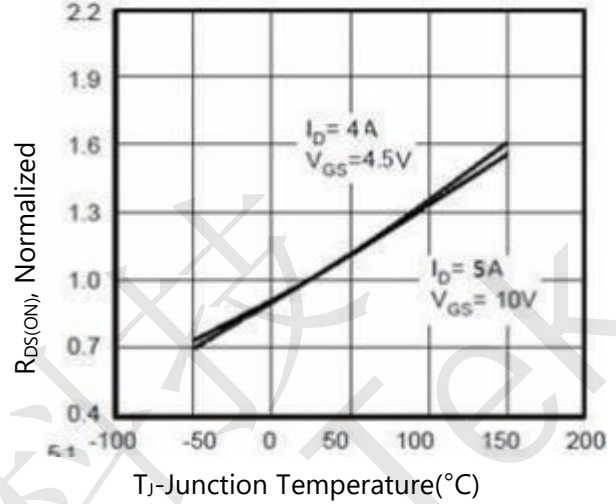

Figure7. Max BV_{DSS} vs Junction Temperature

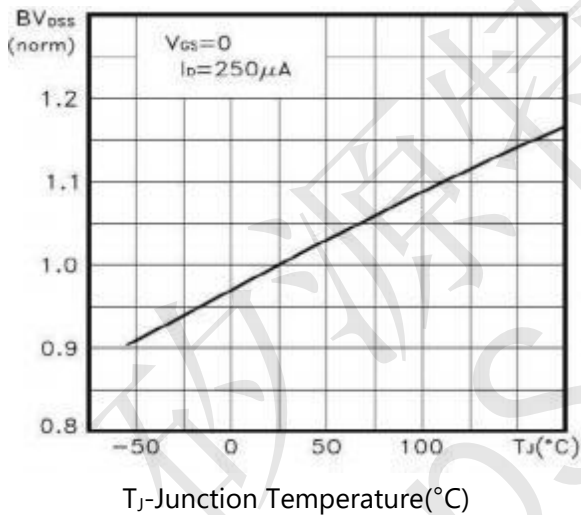

Figure8. $V_{GS(th)}$ vs Junction Temperature

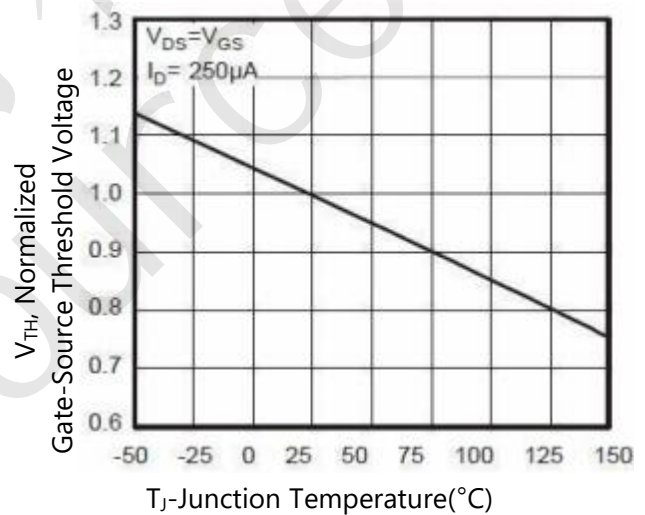

Figure9 Gate Charge Waveforms

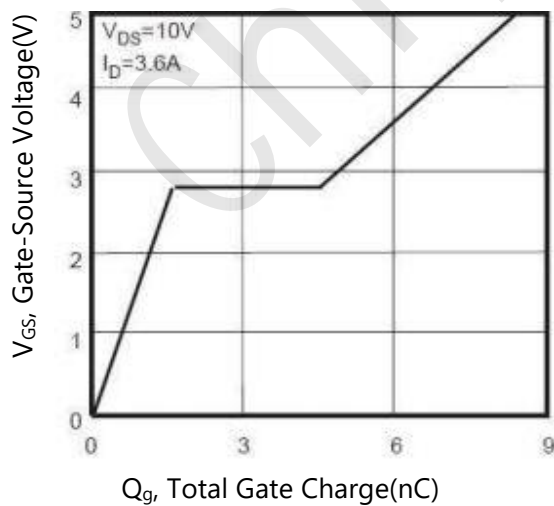
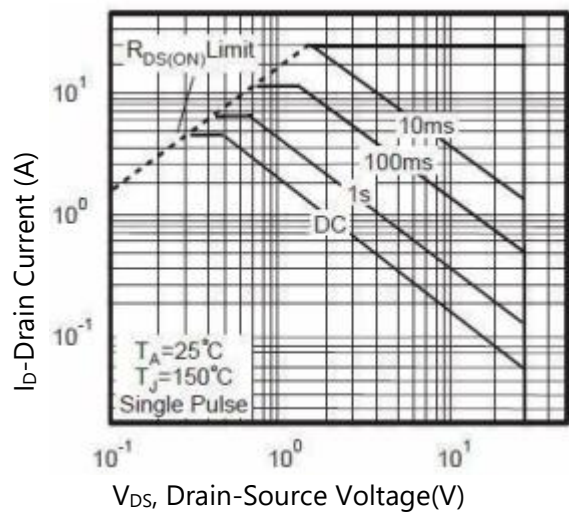

Figure10. Maximum Safe Operating Area





PACKAGE INFORMATION

TO-252

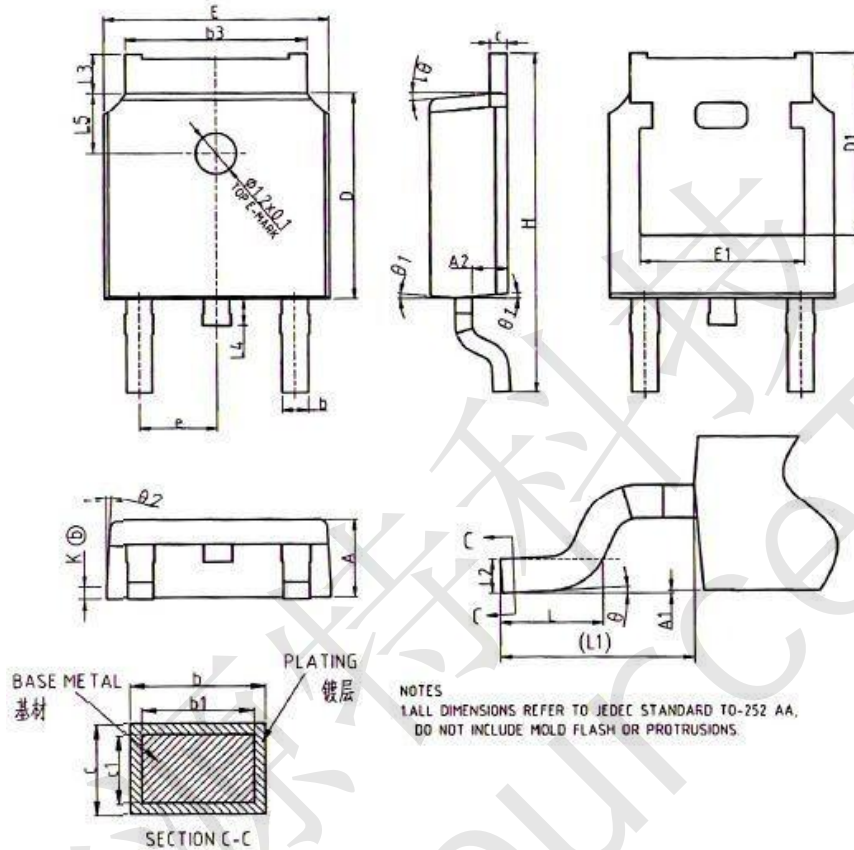

SYMBOL	COMMON DIMENSIONS IN MILLIMETERS			SYMBOL	COMMON DIMENSIONS IN MILLIMETERS		
	MIN	NOM	MAX		MIN	NOM	MAX
A	2.20	2.30	2.38	H	9.90	10.10	10.30
A1	0.00	-	0.10	L	1.40	1.50	1.70
A2	0.97	1.07	1.17	L1	2.90REF		
b	0.72	0.78	0.85	L2	0.51BSC		
b1	0.71	0.76	0.81	L3	0.90	-	1.25
b3	5.23	5.33	5.46	L4	0.60	0.80	1.00
c	0.47	0.53	0.58	L5	1.70	1.80	1.90
c1	0.46	0.51	0.56	θ	0°	-	8°
D	6.00	6.10	6.20	θ1	5°	7°	9°
D1	5.30REF			θ2	5°	7°	9°
E	6.50	6.60	6.70	K	0.40REF		
E1	4.70	4.83	4.92				
e	2.286BSC						