



-30V/-100A P-Channel Advanced Power MOSFET

VS3506AT

Features

- P-Channel, -5V Logic Level Control
- Enhancement mode
- Low on-resistance RDS(on) @ VGS=-4.5 V
- Fast Switching and High efficiency
- 100% Avalanche Tested
- Pb-free lead plating; RoHS compliant

V_{DS}	-30	V
$R_{DS(on),TYP} @ V_{GS}=-10V$	6.2	mΩ
$R_{DS(on),TYP} @ V_{GS}=-4.5V$	10	mΩ
I_D	-100	A



TO-220AB

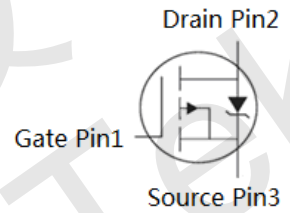
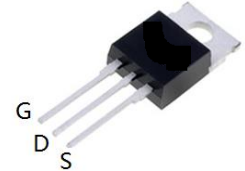

Part ID	Package Type	Marking	Tape and reel information
VS3506AT	TO-220AB	3506AT	50pcs/Tube

Maximum ratings, at T_A =25 °C, unless otherwise specified

Symbol	Parameter	Rating	Unit
$V_{(BR)DSS}$	Drain-Source breakdown voltage	-30	V
V _{GS}	Gate-Source voltage	±20	V
I _S	Diode continuous forward current	T _C =25°C	-100 A
I _D	Continuous drain current @V _{GS} =-10V	T _C =25°C	-100 A
		T _C =100°C	-71 A
I _{DM}	Pulse drain current tested ①	T _C =25°C	-400 A
I _{DSM}	Continuous drain current @V _{GS} =-10V	T _A =25°C	-15 A
		T _A =70°C	-12 A
EAS	Avalanche energy, single pulsed ②	163	mJ
P _D	Maximum power dissipation	T _C =25°C	94 W
P _{DSM}	Maximum power dissipation ③	T _A =25°C	2 W
T _{STG} , T _J	Storage and Junction Temperature Range	-55 to 175	°C

Thermal Characteristics

R _{θJC}	Thermal Resistance, Junction-to-Case	1.6	°C/W
R _{θJA}	Thermal Resistance, Junction-to-Ambient	62.5	°C/W



Typical Characteristics

Symbol	Parameter	Condition	Min.	Typ.	Max.	Unit
Static Electrical Characteristics @ T_J = 25°C (unless otherwise stated)						
V _{(BR)DSS}	Drain-Source Breakdown Voltage	V _{GS} =0V, I _D =-250μA	-30	--	--	V
I _{DSS}	Zero Gate Voltage Drain Current	V _{DS} =-30V, V _{GS} =0V	--	--	-1	μA
	Zero Gate Voltage Drain Current(T _J =125°C)	V _{DS} =-30V, V _{GS} =0V	--	--	-100	μA
I _{GSS}	Gate-Body Leakage Current	V _{GS} =±20V, V _{DS} =0V	--	--	±100	nA
V _{GS(TH)}	Gate Threshold Voltage	V _{DS} =V _{GS} , I _D =-250μA	-1.2	--	-2.3	V
R _{DS(ON)}	Drain-Source On-State Resistance ④	V _{GS} =-10V, I _D =-30A	--	6.2	8.7	mΩ
R _{DS(ON)}	Drain-Source On-State Resistance ④	V _{GS} =-4.5V, I _D =-20A	--	10	14	mΩ
Dynamic Electrical Characteristics @ T_J = 25°C (unless otherwise stated)						
C _{iss}	Input Capacitance	V _{DS} =-15V, V _{GS} =0V, f=1MHz	3765	4430	5090	pF
C _{oss}	Output Capacitance		445	525	600	pF
C _{rss}	Reverse Transfer Capacitance		365	430	490	pF
R _g	Gate Resistance	f=1MHz	--	4.6	--	Ω
Q _g (10V)	Total Gate Charge	V _{DS} =-15V, I _D =-30A, V _{GS} =-10V	--	73	--	nC
Q _g (4.5V)	Total Gate Charge		--	41	--	nC
Q _{gs}	Gate-Source Charge		--	12	--	nC
Q _{gd}	Gate-Drain Charge		--	18	--	nC
Switching Characteristics						
t _{d(on)}	Turn-on Delay Time	V _{DD} =-15V, I _D =-30A, R _G =3.0Ω, V _{GS} =-10V	--	12	--	ns
t _r	Turn-on Rise Time		--	8.5	--	ns
t _{d(off)}	Turn-Off Delay Time		--	77.5	--	ns
t _f	Turn-Off Fall Time		--	19.5	--	ns
Source- Drain Diode Characteristics @ T_J = 25°C (unless otherwise stated)						
V _{SD}	Forward on voltage	I _{SD} =-30A, V _{GS} =0V	--	-0.9	-1.2	V
t _{rr}	Reverse Recovery Time	T _J =25°C, I _{sd} =-30A, V _{GS} =0V	--	31	--	ns
Q _{rr}	Reverse Recovery Charge	di/dt=-500A/μs	--	15.5	--	nC

NOTE:

- ① Repetitive rating; pulse width limited by max junction temperature.
- ② Limited by T_{Jmax}, starting T_J = 25°C, L = 0.5mH, R_G = 25Ω, I_{AS} = -20A, V_{GS} = -10V. Part not recommended for use above this value
- ③ The power dissipation P_{DSM} is based on R_{θJA} and the maximum allowed junction temperature of 150°C.
- ④ Pulse width ≤ 300μs; duty cycles ≤ 2%.



Typical Characteristics

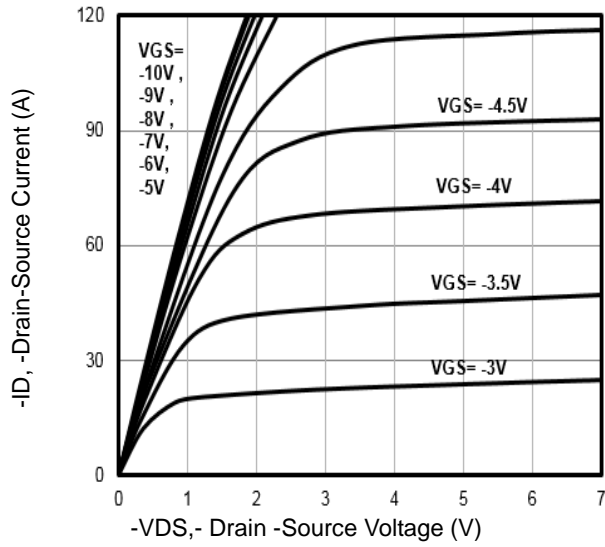

Fig1. Typical Output Characteristics

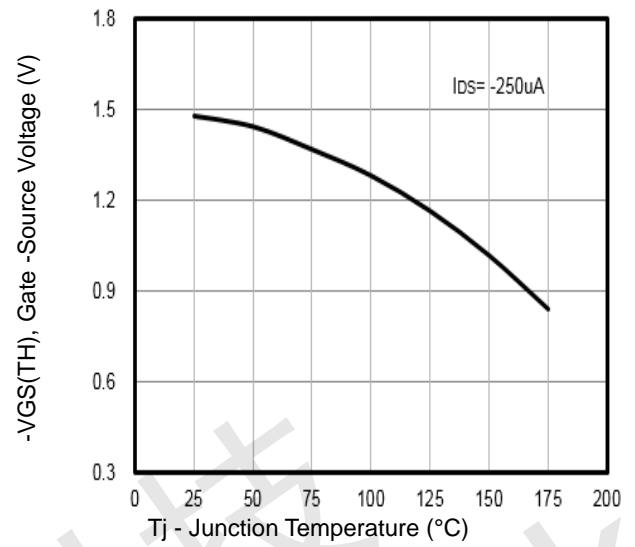

Fig2. -VGS(TH) Gate -Source Voltage Vs. Tj

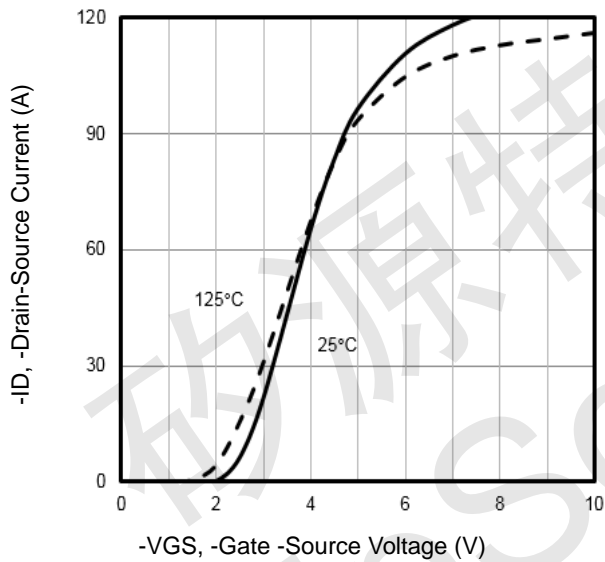

Fig3. Typical Transfer Characteristics

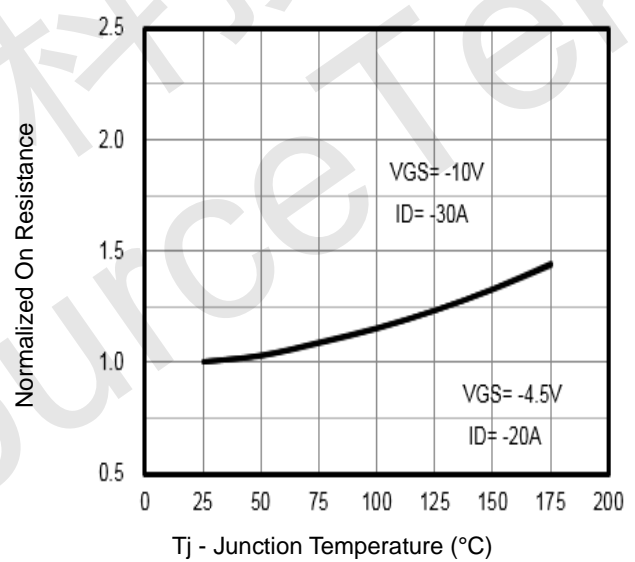

Fig4. Normalized On-Resistance Vs. Tj

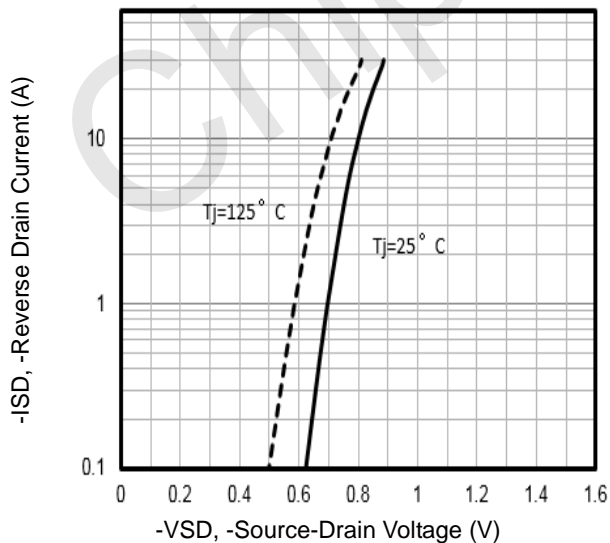

Fig5. Typical Source-Drain Diode Forward Voltage

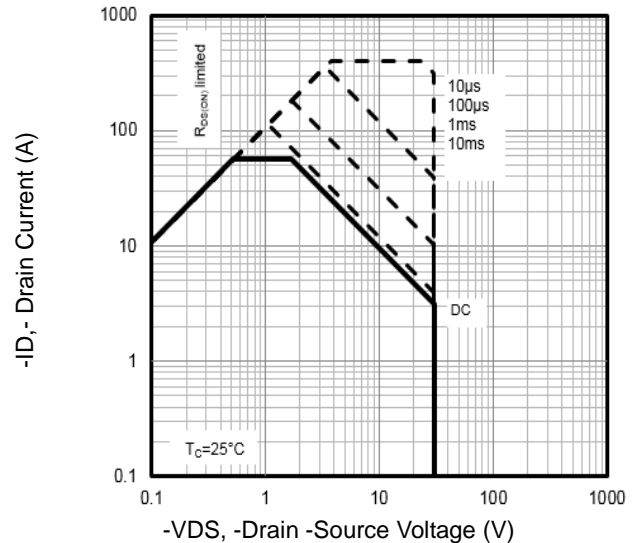

Fig6. Maximum Safe Operating Area



Typical Characteristics

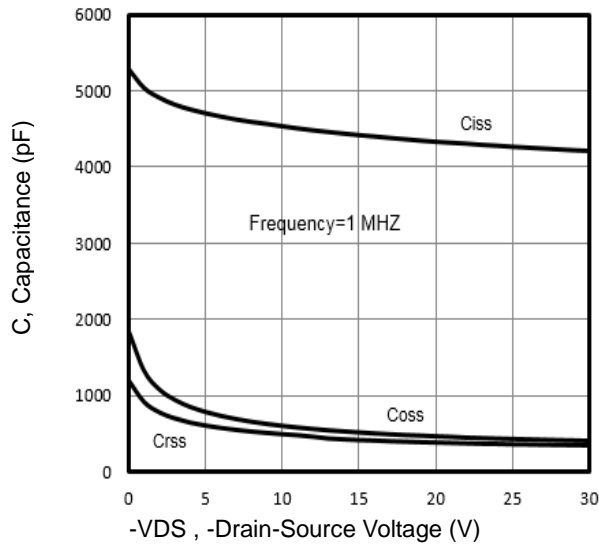

Fig7. Typical Capacitance Vs. Drain-Source Voltage

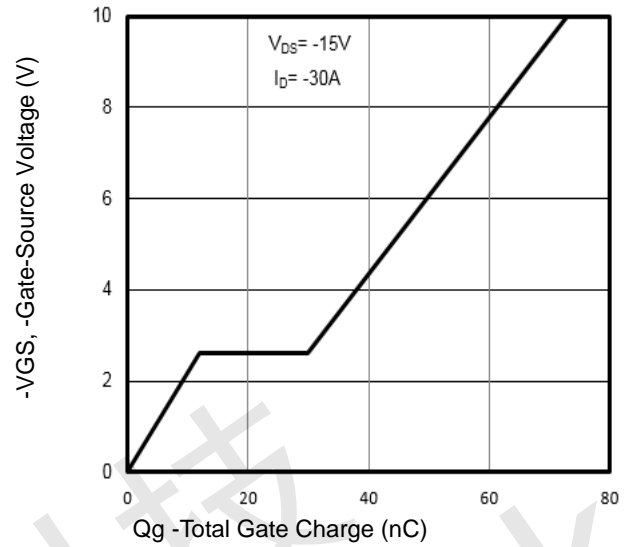

Fig8. Typical Gate Charge Vs. Gate-Source Voltage

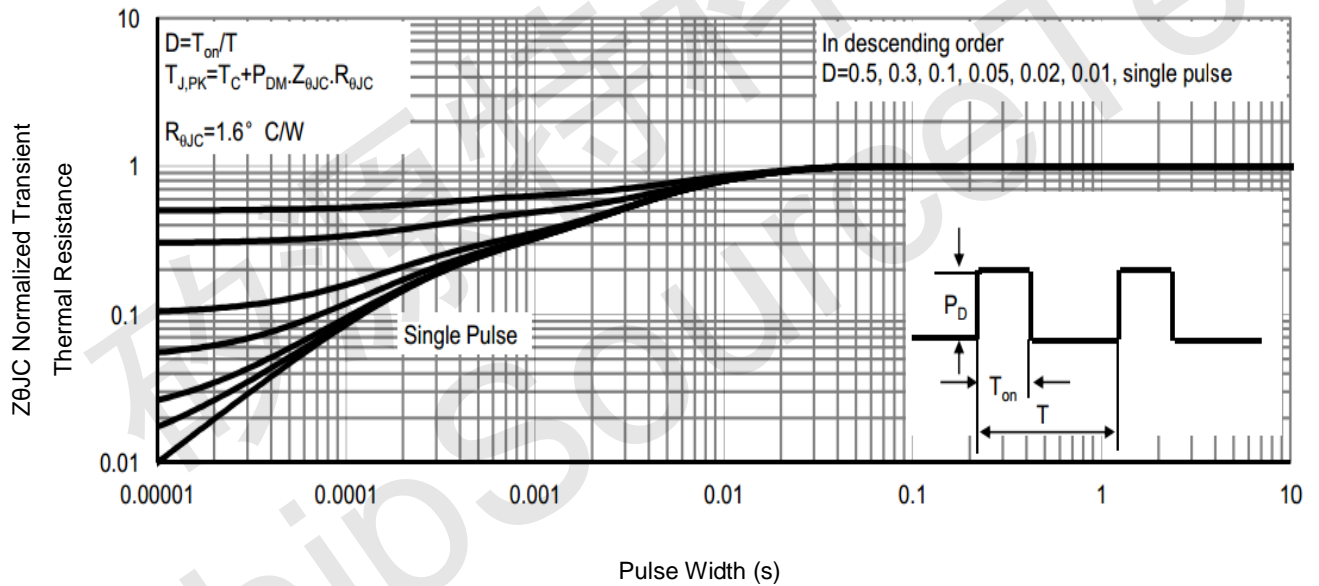

Fig9. Normalized Maximum Transient Thermal Impedance

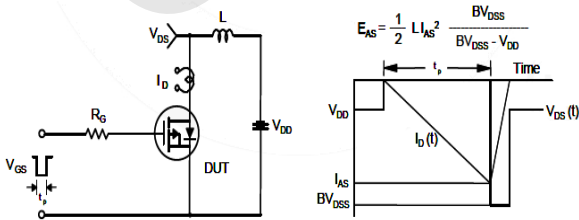

Fig10. Unclamped Inductive Test Circuit and Waveforms

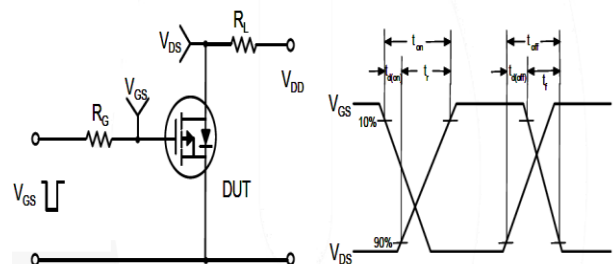
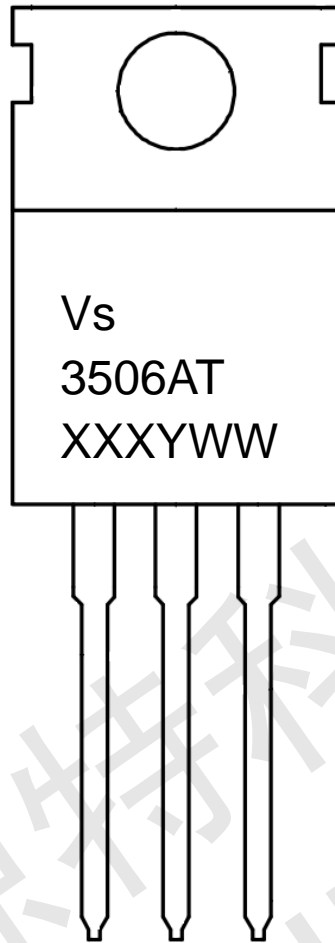

Fig11. Switching Time Test Circuit and waveforms



-30V/-100A P-Channel Advanced Power MOSFET
Marking Information

VS3506AT



- 1st line: Vanguard Code (Vs)
2nd line: Part Number (3506AT)
3rd line: Date code (XXXYWW)
XXX: Wafer Lot Number
Y: Year Code, e.g. E means 2017
WW: Week Code



TO-220AB Package Outline Data

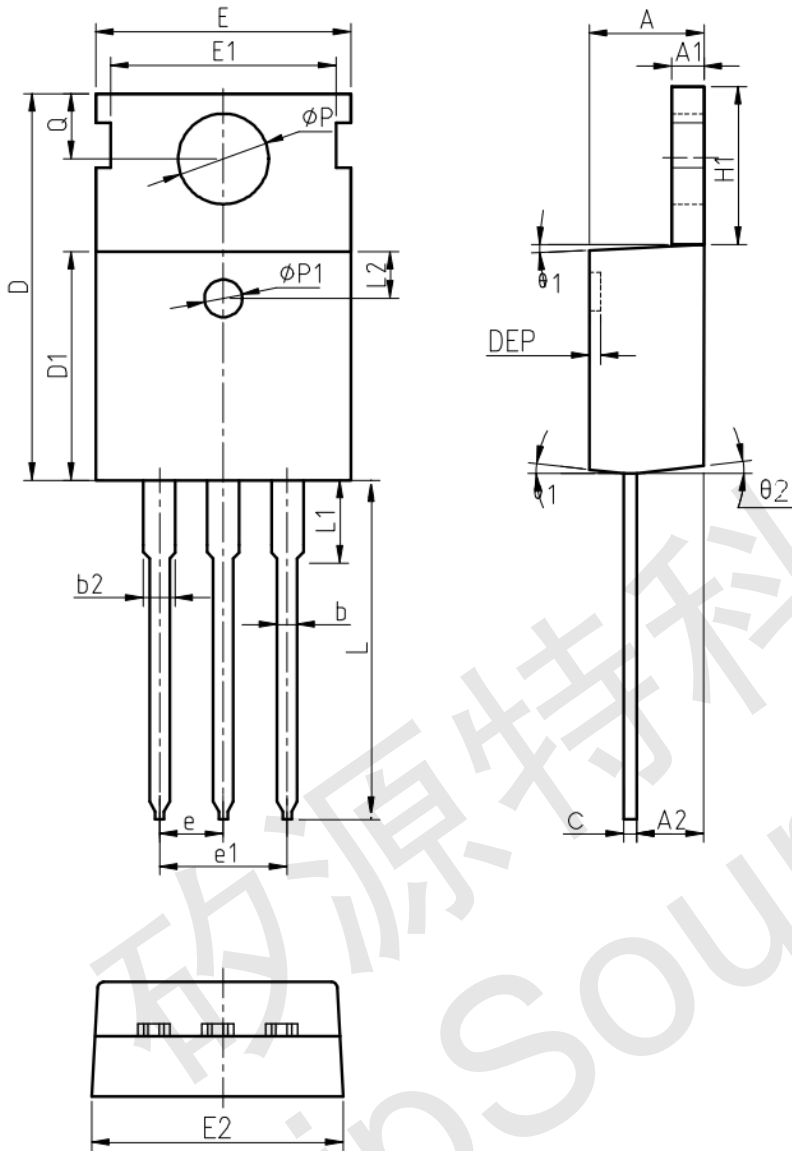

Symbol	Dimensions (unit: mm)		
	Min	Typ	Max
A	4.30	4.52	4.70
A1	1.15	1.30	1.40
A2	2.20	2.40	2.60
b	0.70	0.80	1.00
b2	1.17	1.32	1.50
c	0.45	0.50	0.61
D	15.30	15.65	15.90
D1	9.00	9.20	9.40
DEP	0.05	0.10	0.25
E	9.66	9.90	10.28
E1	-	8.70	-
E2	9.80	10.00	10.20
phi P1	1.40	1.50	1.60
e	2.54 BSC		
e1	5.08 BSC		
H1	6.40	6.50	6.80
L	12.70	-	14.27
L1	-	-	3.95
L2	2.40	2.50	2.60
phi P	3.53	3.60	3.70
Q	2.70	2.80	2.90
theta 1	5 °	7 °	9 °
theta 2	1 °	3 °	5 °

Notes:

1. Refer to JEDEC TO-220 variation AB
2. Dimension "D" and "E" do NOT include mold flash. Mold flash shall not exceed 0.127mm per side.