



CST2300D

N-Ch 20V Fast Switching Mosfet

- ★ Green Device Available
- ★ Super Low Gate Charge
- ★ Excellent Cdv/dt effect decline
- ★ Advanced high cell density Trench technology



Product Summary

BVDSS	RDSON	ID
20V	21mΩ	5.2A

Description

The CST2300D is the high cell density trenched N-ch MOSFETs, which provides excellent RDSON and efficiency for most of the small power switching and load switch applications.

The CST2300D meets the RoHS and Green Product requirement with full function reliability approved.

Absolute Maximum Ratings

Symbol	Parameter	Rating	Units
V_{DS}	Drain-Source Voltage	20	V
V_{GS}	Gate-Source Voltage	± 12	V
$I_D@T_A=25^\circ C$	Continuous Drain Current, $V_{GS} @ 4.5V^1$	5.2	A
$I_D@T_A=70^\circ C$	Continuous Drain Current, $V_{GS} @ 4.5V^1$	3.0	A
I_{DM}	Pulsed Drain Current ²	16.4	A
$P_D@T_A=25^\circ C$	Total Power Dissipation ³	1.0	W
T_{STG}	Storage Temperature Range	-55 to 150	$^\circ C$
T_J	Operating Junction Temperature Range	-55 to 150	$^\circ C$

SOT23 Pin Configuration

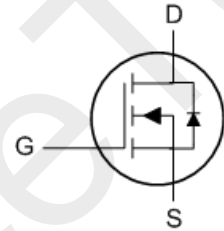
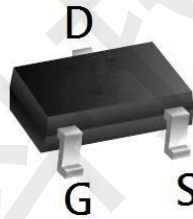

Thermal Data

Symbol	Parameter	Typ.	Max.	Unit
$R_{\theta JA}$	Thermal Resistance Junction-ambient ¹	---	170	$^\circ C/W$
$R_{\theta JC}$	Thermal Resistance Junction-Case ¹	---	---	$^\circ C/W$



Electrical Characteristics ($T_J=25^{\circ}\text{C}$ unless otherwise specified)

Symbol	Parameter	Test Condition	Min.	Typ.	Max.	Units
Off Characteristic						
$V_{(BR)DSS}$	Drain-Source Breakdown Voltage	$V_{GS}=0V, I_D=250\mu A$	20	-	-	V
I_{DSS}	Zero Gate Voltage Drain Current	$V_{DS}=20V, V_{GS}=0V,$	-	-	1.0	μA
I_{GSS}	Gate to Body Leakage Current	$V_{DS}=0V, V_{GS}=\pm 12V$	-	-	± 100	nA
On Characteristics						
$V_{GS(th)}$	Gate Threshold Voltage	$V_{DS}=V_{GS}, I_D=250\mu A$	0.4	0.7	1	V
$R_{DS(on)}$	Static Drain-Source on-Resistance <small>note2</small>	$V_{GS}=4.5V, I_D=4A$	-	21	27	m Ω
		$V_{GS}=2.5V, I_D=3A$	-	29	44	
Dynamic Characteristics						
C_{iss}	Input Capacitance	$V_{DS}=10V, V_{GS}=0V,$ $f=1.0MHz$	-	358	-	pF
C_{oss}	Output Capacitance		-	69.3	-	pF
C_{riss}	Reverse Transfer Capacitance		-	58.5	-	pF
Q_g	Total Gate Charge	$V_{DS}=10V, I_D=2A,$ $V_{GS}=4.5V$	-	5.6	-	nC
Q_{gs}	Gate-Source Charge		-	0.8	-	nC
Q_{gd}	Gate-Drain("Miller") Charge		-	1	-	nC
Switching Characteristics						
$t_{d(on)}$	Turn-on Delay Time	$V_{DS}=10V,$ $I_D=4A, R_{GEN}=3\Omega,$ $V_{GS}=4.5V$	-	5	-	ns
t_r	Turn-on Rise Time		-	30	-	ns
$t_{d(off)}$	Turn-off Delay Time		-	48	-	ns
t_f	Turn-off Fall Time		-	36	-	ns
Drain-Source Diode Characteristics and Maximum Ratings						
I_S	Maximum Continuous Drain to Source Diode Forward Current		-	-	4	A
I_{SM}	Maximum Pulsed Drain to Source Diode Forward Current		-	-	16	A
V_{SD}	Drain to Source Diode Forward Voltage	$V_{GS}=0V, I_S=4A$	-	-	1.2	V

Notes: 1. Repetitive Rating: Pulse Width Limited by Maximum Junction Temperature

2. Pulse Test: Pulse Width $\leq 300\mu s$, Duty Cycle $\leq 0.5\%$



Typical Performance Characteristics

Figure 1: Output Characteristics

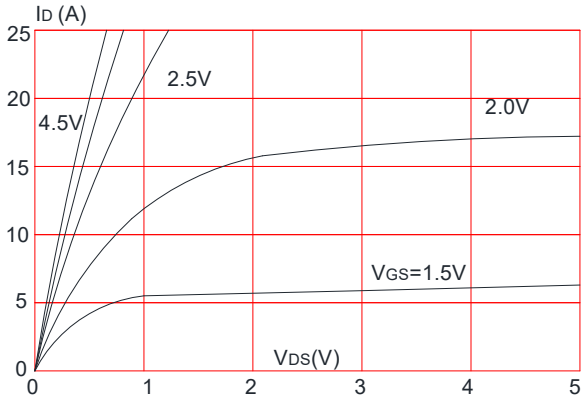

Figure 2: Typical Transfer Characteristics

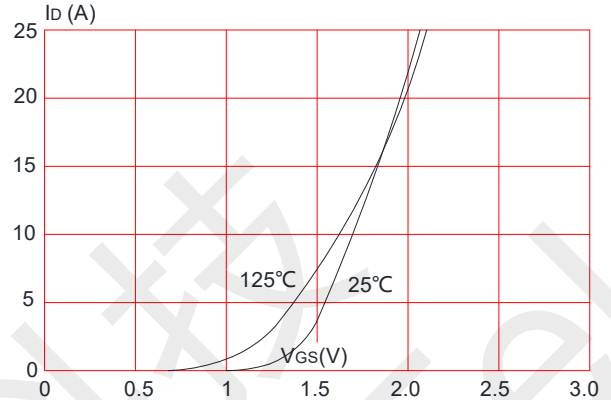

Figure 3: On-resistance vs. Drain Current

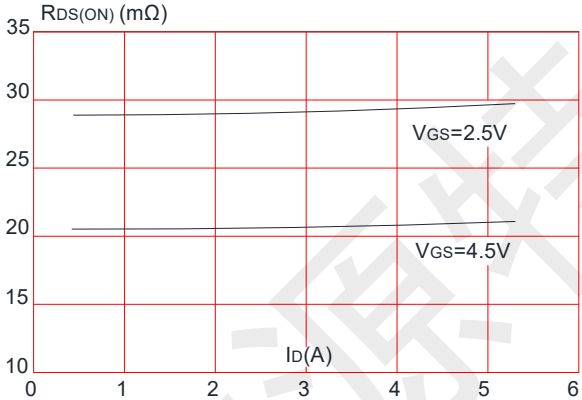

Figure 4: Body Diode Characteristics

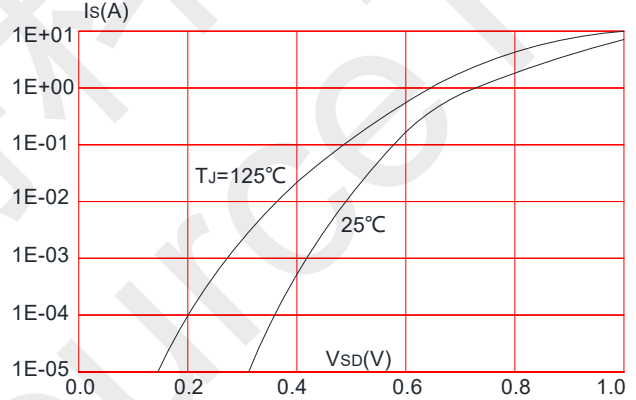

Figure 5: Gate Charge Characteristics

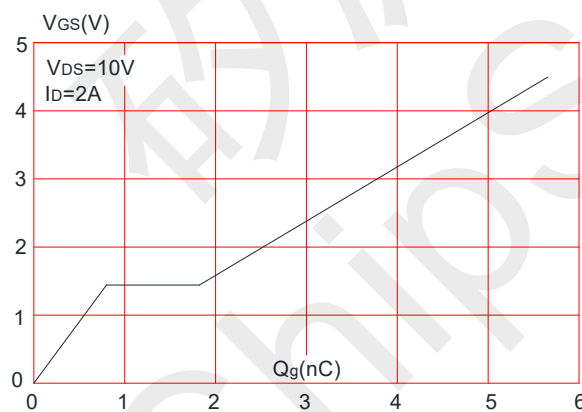
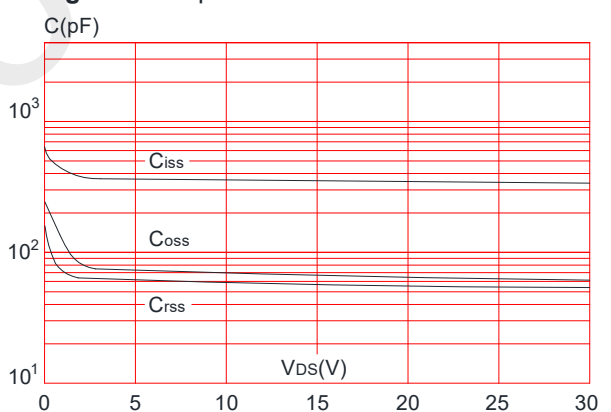

Figure 6: Capacitance Characteristics





CST2300D

N-Ch 20V Fast Switching Mosfet

Figure 7: Normalized Breakdown Voltage vs. Junction Temperature

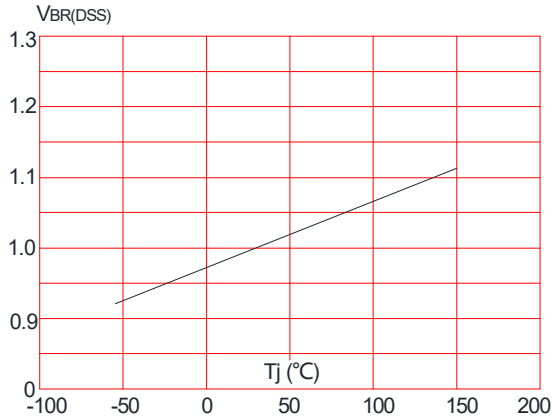

Figure 8: Normalized on Resistance vs. Junction Temperature

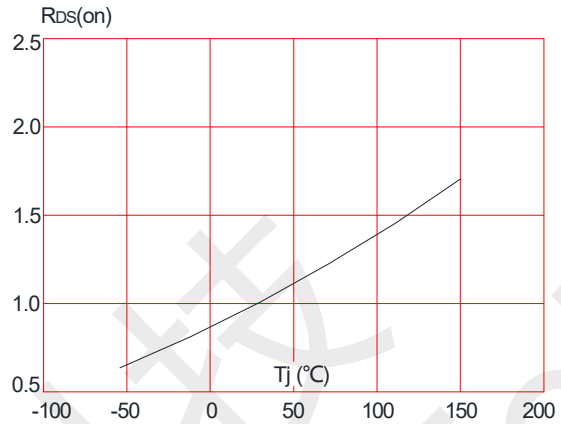

Figure 9: Maximum Safe Operating Area

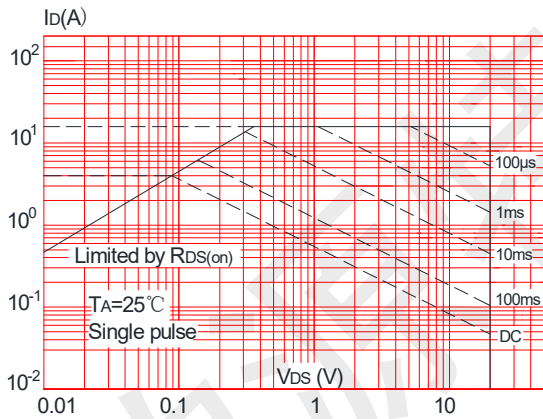

Figure 10: Maximum Continuous Drain Current vs. Ambient Temperature

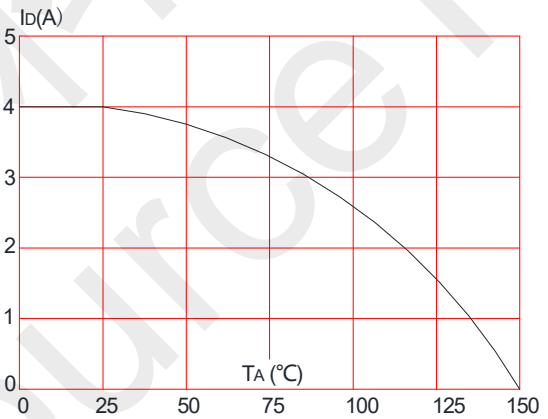
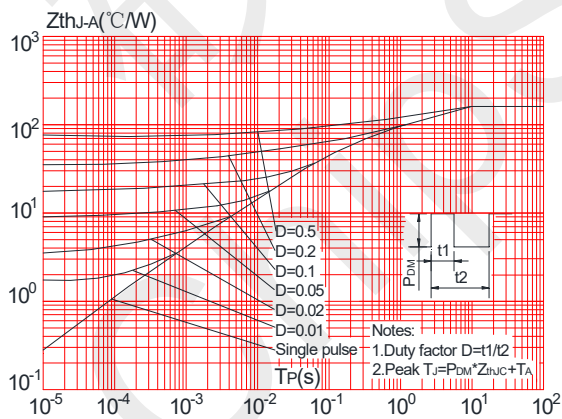
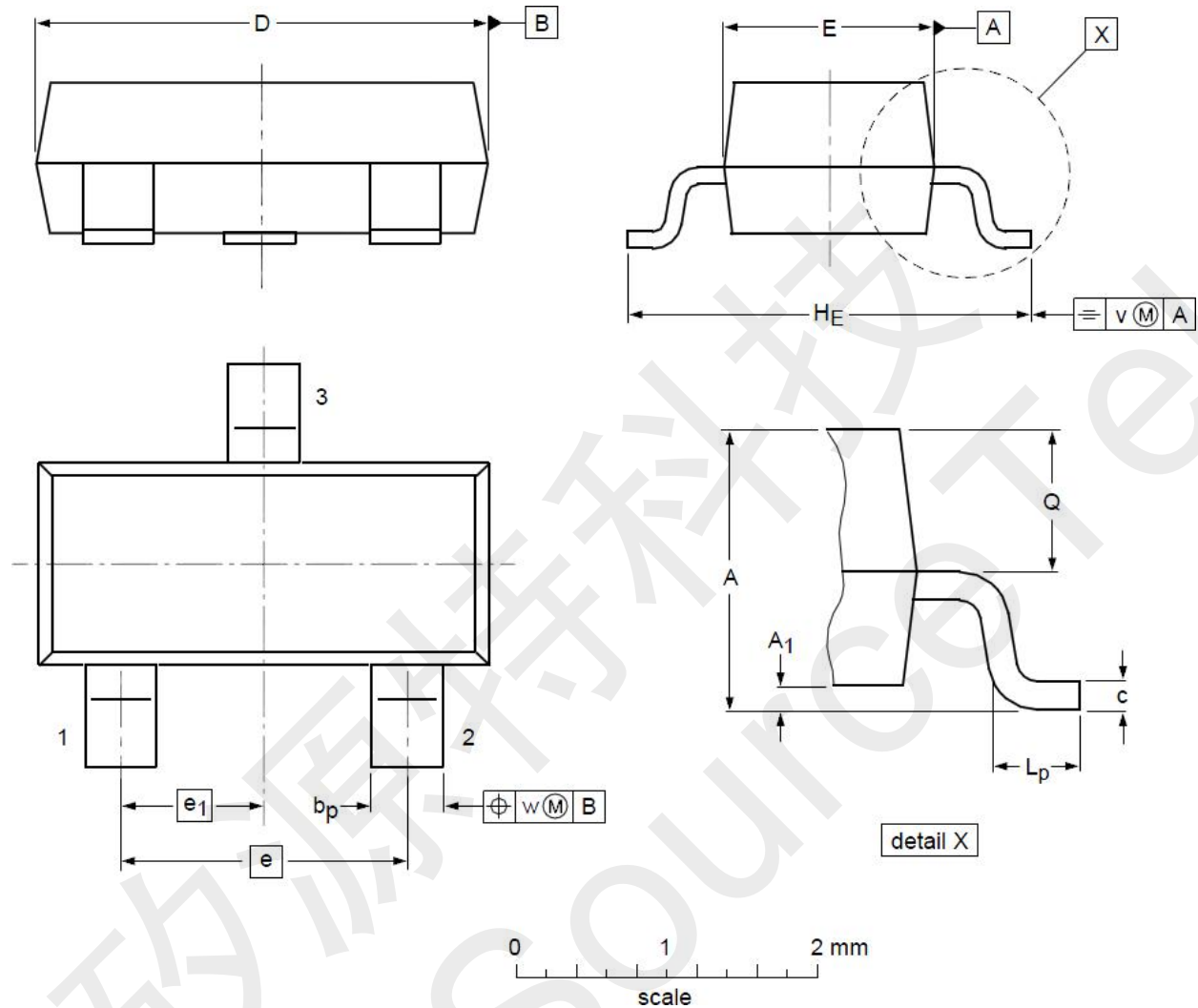

Figure.11: Maximum Effective Transient Thermal Impedance, Junction-to-Ambient





Package Mechanical Data-SOT-23



DIMENSIONS (unit : mm)

Symbol	Min	Typ	Max	Symbol	Min	Typ	Max
A	0.90	1.01	1.15	A ₁	0.01	0.05	0.10
b _p	0.30	0.42	0.50	c	0.08	0.13	0.15
D	2.80	2.92	3.00	E	1.20	1.33	1.40
e	--	1.90	--	e ₁	--	0.95	--
H _E	2.25	2.40	2.55	L _p	0.30	0.42	0.50
Q	0.45	0.49	0.55	v	--	0.20	--
w	--	0.10	--				