



N-Channel Enhancement Mode Power MOSFET **MXN3342**

DESCRIPTION

The MXN3342 uses advanced trench technology to provide excellent $R_{DS(ON)}$ and low gate charge. It can be used in a wide variety of applications.

GENERAL FEATURES

- $V_{DS}=30V$, $I_D=35A$
 $R_{DS(ON)}$ (Typ.)=10m Ω @ $V_{GS}=4.5V$
 $R_{DS(ON)}$ (Typ.)=6.5m Ω @ $V_{GS}=10V$
- High Power and current handling capability
- Lead free product is acquired
- Surface Mount Package

APPLICATION

- PWM applications
- Load switch
- Power management
- Battery

PINOUT

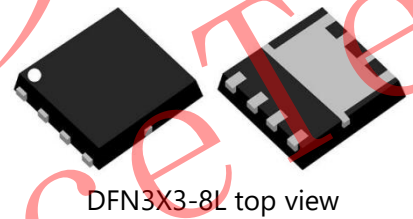
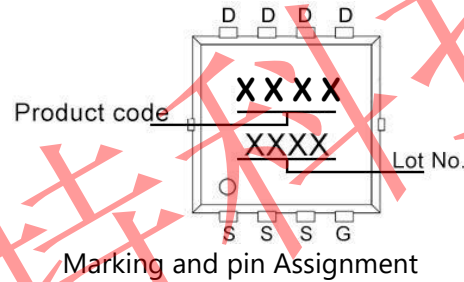
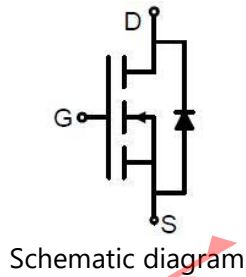

ORDERING INFORMATION

Part Number	Storage Temperature	Package	Devices Per Reel
MXN3342	-55°C to 150°C	DFN3X3-8L	5000

ABSOLUTE MAXIMUM RATINGS($T_A=25^\circ C$ unless otherwise noted)

Parameter	Symbol	Limit	Unit
Drain-Source Voltage	V_{DS}	30	V
Gate-Source Voltage	V_{GS}	± 20	V
Drain Current-Continuous	I_D	35	A
Drain Current-Continuous($T_C=100^\circ C$)	I_D	25	A
Pulsed Drain Current ^(Note1)	I_{DM}	100	A
Maximum Power Dissipation	P_D	25	W
Avalanche Current	I_{AS}	37	A
Avalanche Energy (L=0.1mH)	E_{AS}	68	mJ
Operating Junction and Storage Temperature Range	T_J, T_{STG}	-55 to 150	$^\circ C$

THERMAL RESISTANCE

Thermal Resistance, Junction-to-Case ^(Note2)	$R_{\theta JC}$	5	$^\circ C/W$
---	-----------------	---	--------------

Note 1. Repetitive Rating: Pulse width limited by maximum junction temperature.

Note 2. Surface Mounted on FR4 Board, $t \leq 10$ sec.



N-Channel Enhancement Mode Power MOSFET **MXN3342**



ELECTRICAL CHARACTERISTICS ($T_A=25^\circ\text{C}$ unless otherwise noted)

Parameter	Symbol	Conditions	Min	Typ	Max	Unit
Off Characteristics						
Drain-Source Breakdown Voltage	BV_{DSS}	$V_{GS}=0V, I_D=250\mu A$	30	-	-	V
Zero Gate Voltage Drain Current	I_{DSS}	$V_{DS}=30V, V_{GS}=0V$	-	-	1	μA
Gate-Body Leakage Current	I_{GSS}	$V_{GS}=\pm 20V, V_{DS}=0V$	-	-	± 100	nA
On Characteristics (Note 3)						
Gate Threshold Voltage	$V_{GS(th)}$	$V_{DS}=V_{GS}, I_D=250\mu A$	1	1.6	2.2	V
Drain-Source On-State Resistance	$R_{DS(on)}$	$V_{GS}=4.5V, I_D=16A$	-	10	13	m Ω
		$V_{GS}=10V, I_D=20A$	-	6.2	7.5	m Ω
Forward Transconductance	g_{FS}	$V_{DS}=5V, I_D=10A$	-	32	-	S
Dynamic Characteristics (Note 4)						
Input Capacitance	C_{iss}	$V_{DS}=15V, V_{GS}=0V,$ $F=1.0MHz$	-	1300	-	pF
Output Capacitance	C_{oss}		-	175	-	pF
Reverse Transfer Capacitance (Note 4)	C_{rss}		-	121	-	pF
Switching Characteristics						
Turn-on Delay Time	$t_{d(on)}$	$V_{DD}=15V, R_L=1\Omega,$ $V_{GS}=10V, R_G=3\Omega$	-	4.2	-	nS
Turn-on Rise Time	t_r		-	8.2	-	nS
Turn-Off Delay Time	$t_{d(off)}$		-	31	-	nS
Turn-Off Fall Time	t_f		-	4	-	nS
Total Gate Charge	Q_g	$V_{DS}=15V, I_D=10A,$ $V_{GS}=10V$	-	28	-	nC
Gate-Source Charge	Q_{gs}		-	3.5	-	nC
Gate-Drain Charge	Q_{gd}		-	7	-	nC
Drain-Source Diode Characteristics						
Diode Forward Voltage (Note 3)	V_{SD}	$V_{GS}=0V, I_S=-1A$	-	-	-1.2	V
Diode Forward Current (Note 2)	I_S		-	-	25	A

Note 2. Surface Mounted on FR4 Board, $t \leq 10$ sec.

Note 3. Pulse Test: Pulse Width $\leq 300\mu s$, Duty Cycle $\leq 2\%$.

Note 4. Guaranteed by design, not subject to product.



N-Channel Enhancement Mode Power MOSFET **MXN3342**

TYPICAL ELECTRICAL AND THERMAL CHARACTERISTICS

Figure 1. Switching Test Circuit

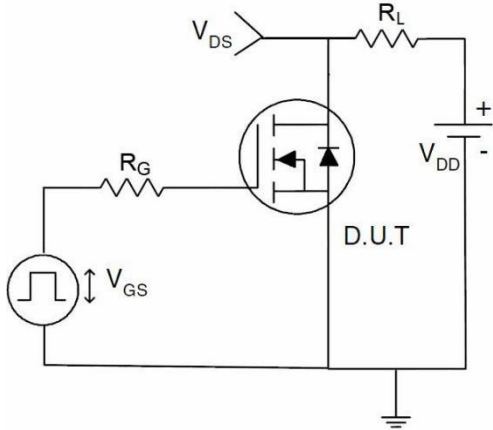

Figure 2. Switching Waveform

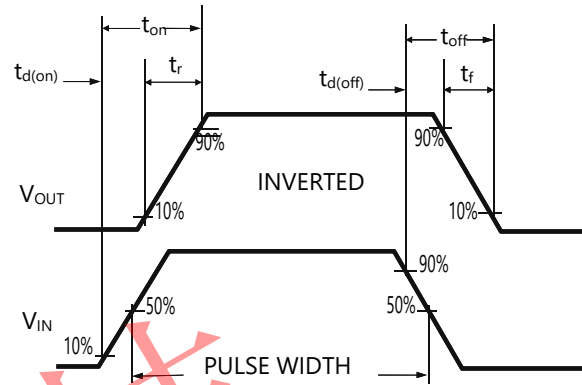

Figure 3. Power De-rating

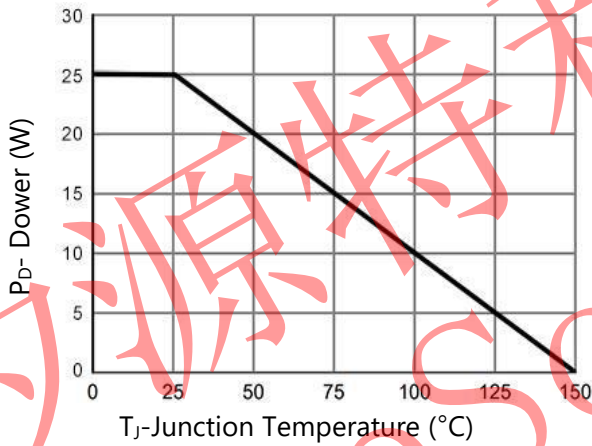

Figure 4. Drain Current

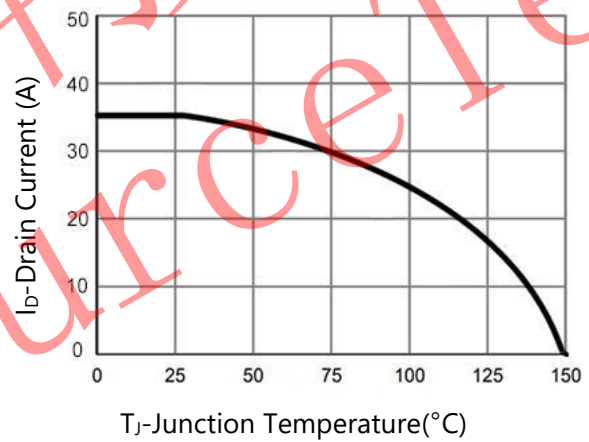

Figure 5. Output Characteristics

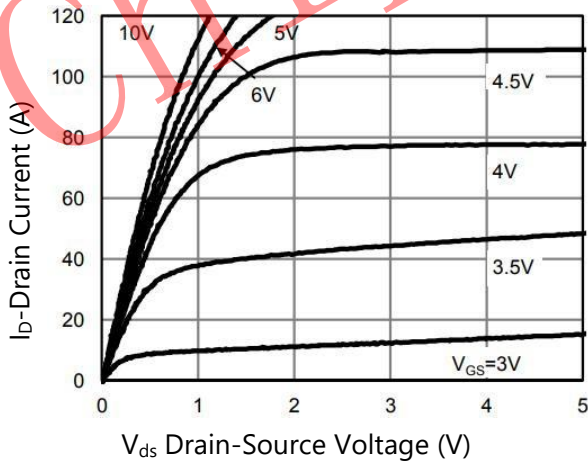
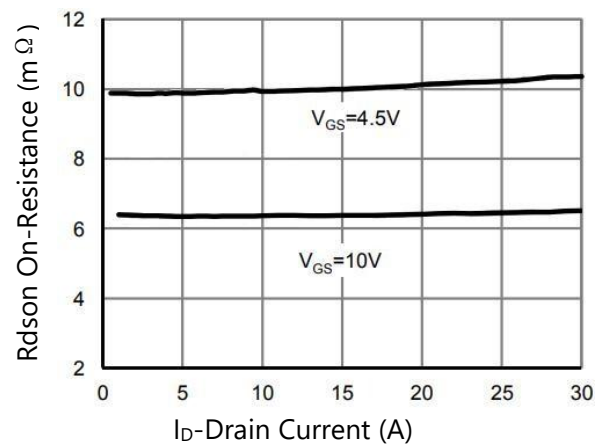

Figure 6. R_{dson} vs Drain Current





N-Channel Enhancement Mode Power MOSFET **MXN3342**

TYPICAL ELECTRICAL AND THERMAL CHARACTERISTICS

Figure 7. Transfer Characteristics

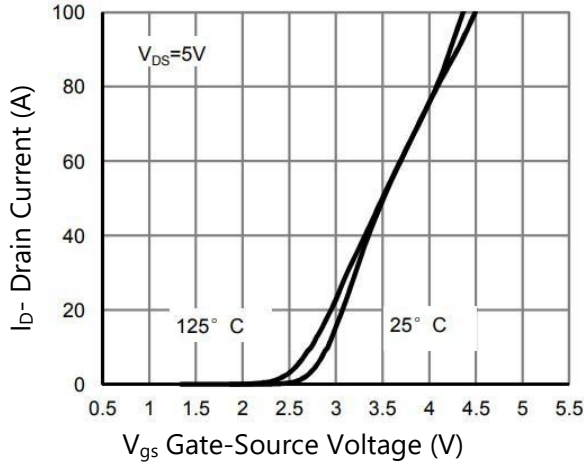

Figure 8. R_{dson} vs Junction Temperature

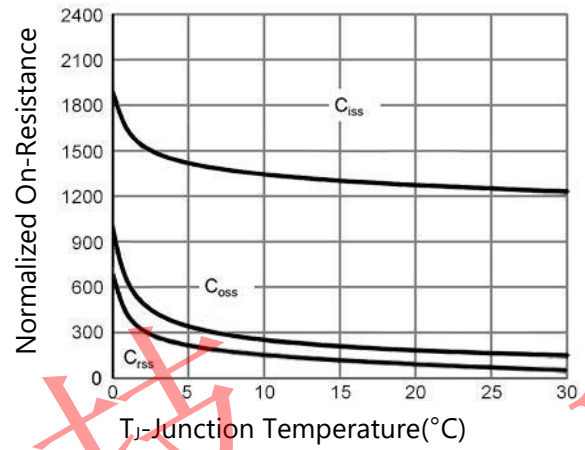

Figure 9. R_{dson} vs V_{gs}

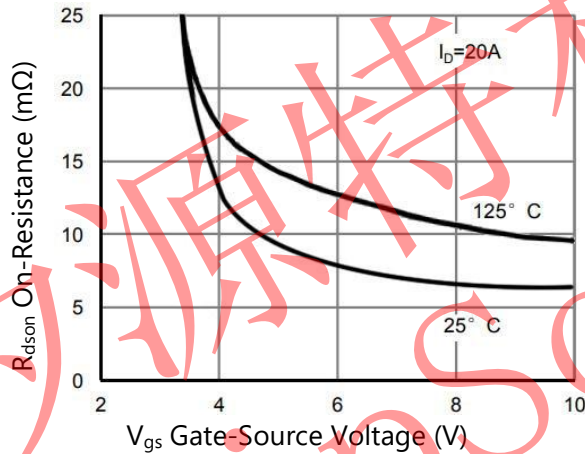

Figure 10. Capacitance vs V_{DS}

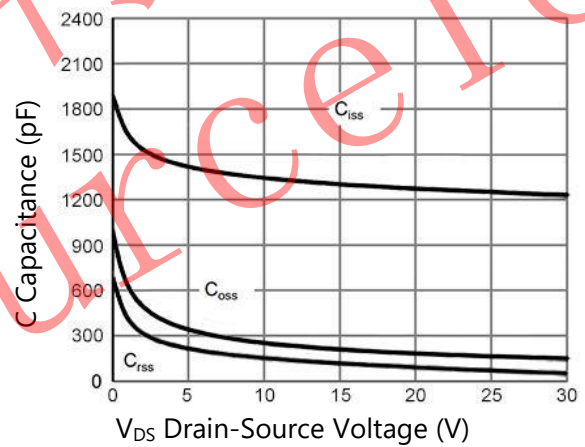

Figure 11. Gate Charge

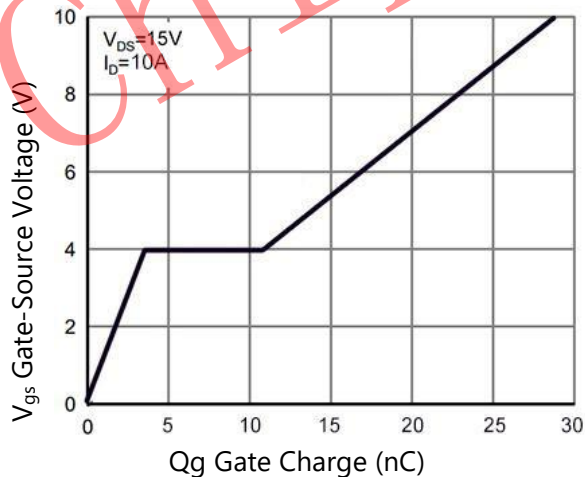
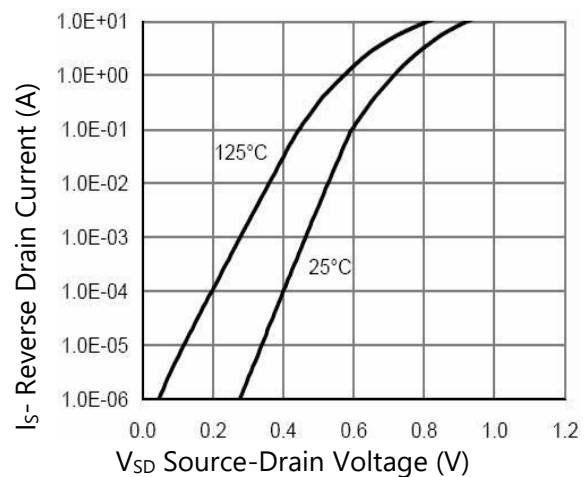

Figure 12. Source- Drain Diode Forward





N-Channel Enhancement Mode Power MOSFET **MXN3342**

TYPICAL ELECTRICAL AND THERMAL CHARACTERISTICS

Figure 13. Safe Operation Area

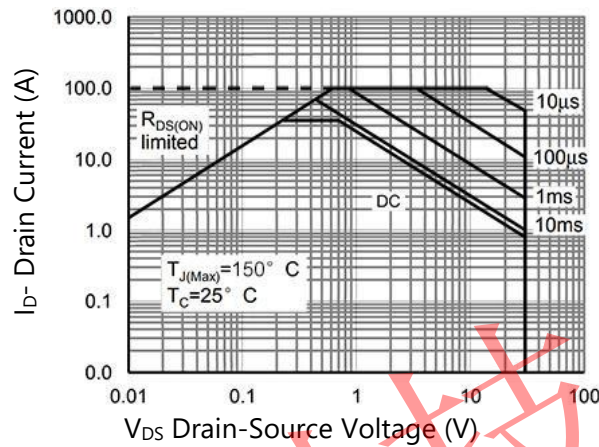
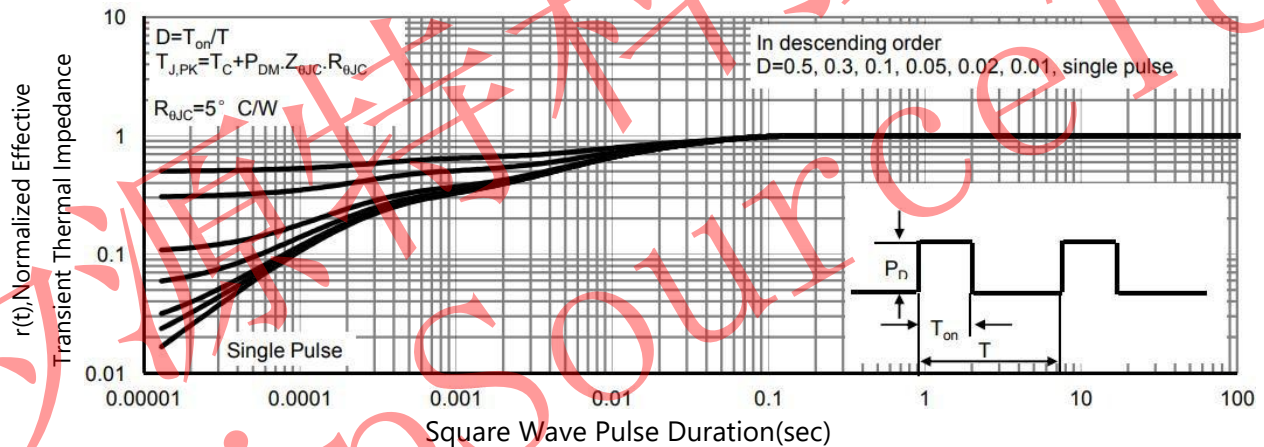

Figure 14. Normalized Maximum Transient Thermal Impedance





N-Channel Enhancement Mode Power MOSFET **MXN3342**

PACKAGE INFORMATION

DFN3X3-8L

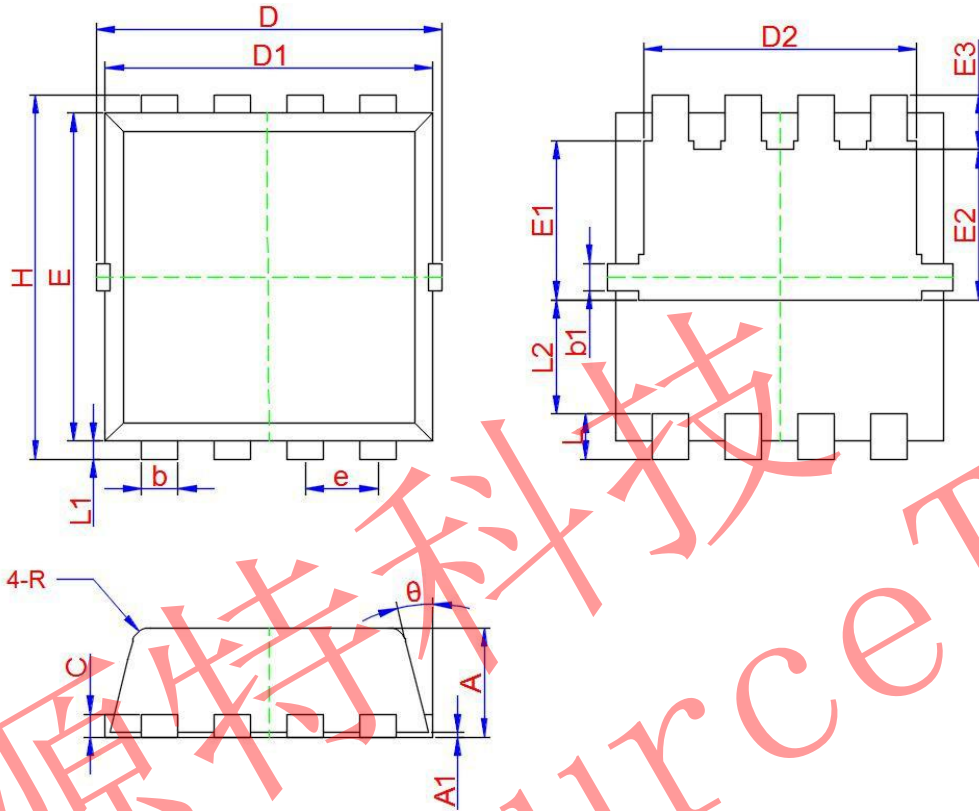

Symbol	Dimensions InMillimeters			Symbol	Dimensions InMillimeters		
	Min.	Typ.	Max.		Min.	Typ.	Max.
A	0.700	0.800	0.900	e	0.650 TYP.		
A1	0.000	0.030	0.050	H	3.200	3.300	3.400
b	0.240	0.300	0.350	L	0.300	0.400	0.500
b1	0.080	0.130	0.180	L1	0.100	0.150	0.200
c	0.152 TYP.			L2	1.130 TYP.		
D	3.250	3.320	3.400	R	0.200 TYP.		
D1	3.050	3.150	3.250	θ	6°	10°	14°
D2	2.400	2.500	2.600				
E	3.000	3.100	3.200				
E1	1.350	1.450	1.550				
E2	1.200	1.300	1.400				
E3	0.400	0.500	0.600				