



N-Channel Enhancement Mode Power MOSFET

Description

The PE8306AH uses advanced trench technology to provide excellent $R_{DS(ON)}$ and low gate charge. It can be used in a wide variety of applications.

General Features

- $V_{DS} = 30V$, $I_D = 6A$

$R_{DS(ON)} < 26m\Omega @ V_{GS}=10V$

$R_{DS(ON)} < 40m\Omega @ V_{GS}=4.5V$

- High Power and current handling capability
- Lead free product is acquired
- Surface Mount Package

Application

- PWM applications
- Load switch
- Power management

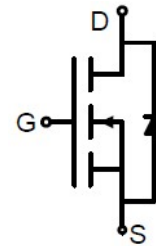

Schematic diagram

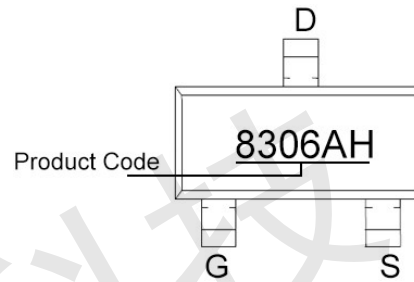

Marking and pin assignment



SOT-23

Absolute Maximum Ratings (TA=25°C unless otherwise noted)

Parameter	Symbol	Rating	Unit
Drain-Source Voltage	V_{DS}	30	V
Gate-Source Voltage	V_{GS}	± 20	V
Drain Current-Continuous	I_D	6	A
Pulsed Drain Current (Note 1)	I_{DM}	30	A
Maximum Power Dissipation	P_D	1.4	W
Operating Junction and Storage Temperature Range	T_J, T_{STG}	-55 To 150	°C

Thermal Characteristic

Thermal Resistance, Junction-to-Ambient (Note 2)	$R_{\theta JA}$	89	°C/W
--	-----------------	----	------



Electrical Characteristics (TA=25°C unless otherwise noted)

Parameter	Symbol	Condition	Min	Typ	Max	Unit
Off Characteristics						
Drain-Source Breakdown Voltage	BV_{DSS}	$V_{GS}=0V, I_D=250\mu A$	30	-	-	V
Zero Gate Voltage Drain Current	I_{DSS}	$V_{DS}=30V, V_{GS}=0V$	-	-	1	μA
Gate-Body Leakage Current	I_{GSS}	$V_{GS}=\pm 20V, V_{DS}=0V$	-	-	± 100	nA
On Characteristics (Note 3)						
Gate Threshold Voltage	$V_{GS(th)}$	$V_{DS}=V_{GS}, I_D=250\mu A$	1.0	1.5	2.2	V
Drain-Source On-State Resistance	$R_{DS(ON)}$	$V_{GS}=10V, I_D=5A$	-	21	26	$m\Omega$
		$V_{GS}=4.5V, I_D=4A$	-	30	40	$m\Omega$
Forward Transconductance	g_{FS}	$V_{DS}=10V, I_D=5.5A$	10	-	-	S
Dynamic Characteristics (Note 4)						
Input Capacitance	C_{iss}	$V_{DS}=15V, V_{GS}=0V,$ $F=1.0MHz$	-	460	-	pF
Output Capacitance	C_{oss}		-	60	-	pF
Reverse Transfer Capacitance (Note 4)	C_{rss}		-	50	-	pF
Gate Resistance	R_g	$V_{DS}=0V, V_{GS}=0V, F=1.0MHz$	-	2	-	Ω
Switching Characteristics						
Turn-on Delay Time	$t_{d(on)}$	$V_{DD}=15V, I_D=2A, R_L=1\Omega,$ $V_{GS}=10V, R_G=3\Omega$	-	4.5	-	nS
Turn-on Rise Time	t_r		-	2.4	-	nS
Turn-Off Delay Time	$t_{d(off)}$		-	14	-	nS
Turn-Off Fall Time	t_f		-	2.5	-	nS
Total Gate Charge	Q_g	$V_{DS}=15V, I_D=6A, V_{GS}=10V$	-	7.1	-	nC
Gate-Source Charge	Q_{gs}		-	1.4	-	nC
Gate-Drain Charge	Q_{gd}		-	2.2	-	nC
Drain-Source Diode Characteristics						
Diode Forward Voltage (Note 3)	V_{SD}	$V_{GS}=0V, I_S=1A$	-	-	1.2	V
Diode Forward Current (Note 2)	I_S		-	-	3	A

Notes:

1. Repetitive Rating: Pulse width limited by maximum junction temperature.
2. Surface Mounted on FR4 Board, $t \leq 10$ sec.
3. Pulse Test: Pulse Width $\leq 300\mu s$, Duty Cycle $\leq 2\%$.
4. Guaranteed by design, not subject to product.



Typical Electrical and Thermal Characteristics

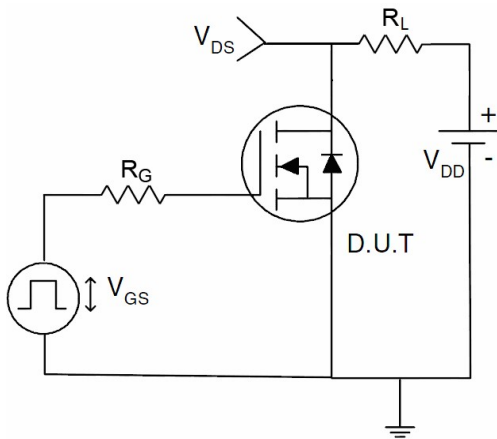

Figure 1 Switching Test Circuit

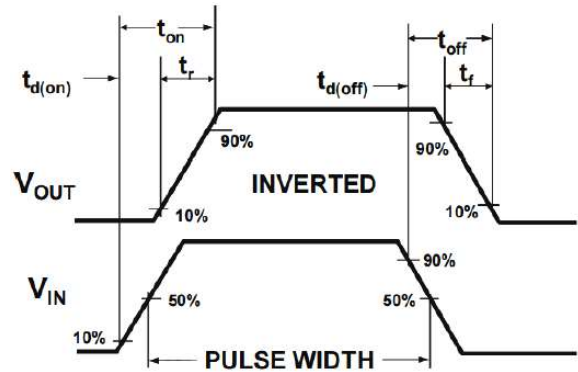

Figure 2 Switching Waveform

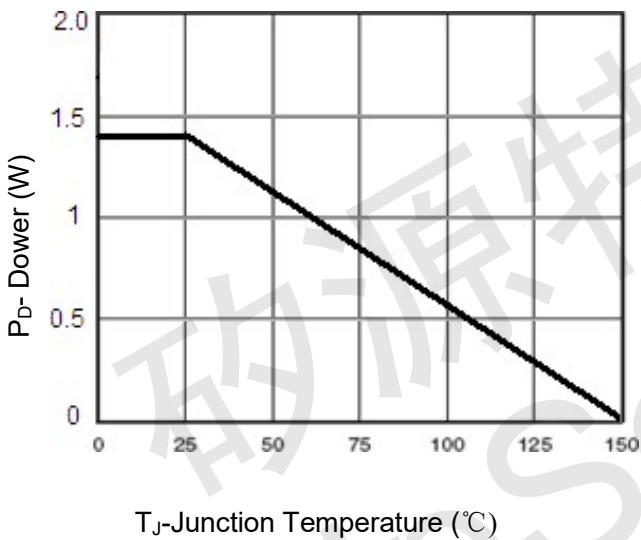

Figure 3 Power De-rating

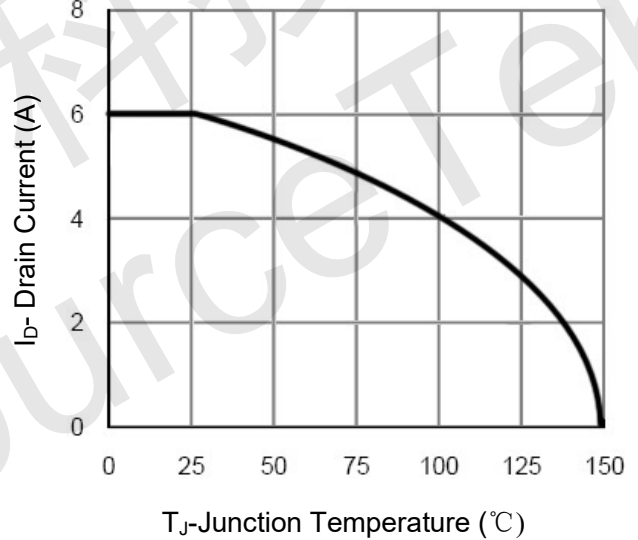

Figure 4 Drain Current

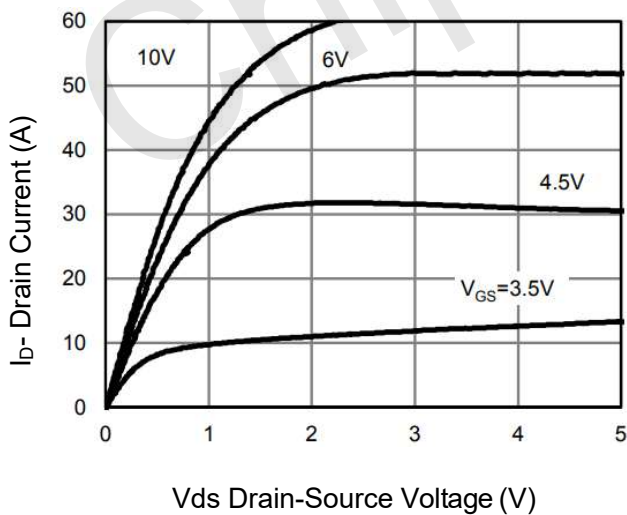

Figure 5 Output Characteristics

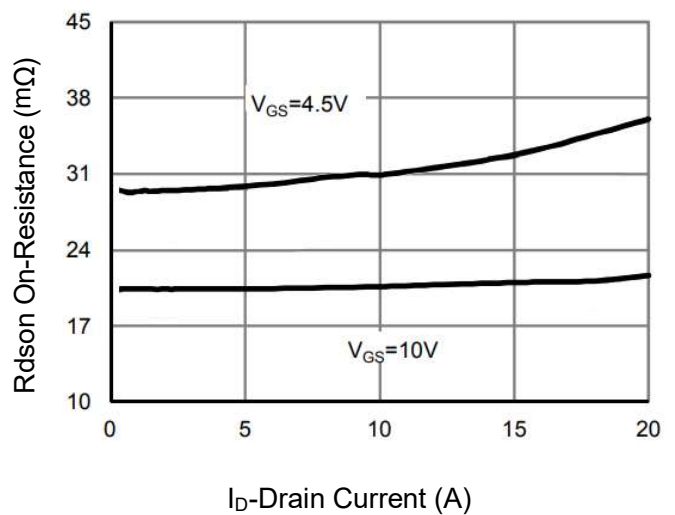

Figure 6 Rdson vs Drain Current

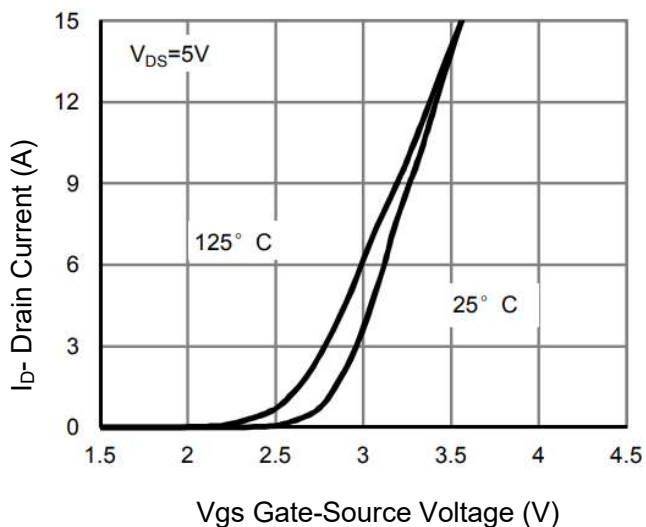

Figure 7 Transfer Characteristics

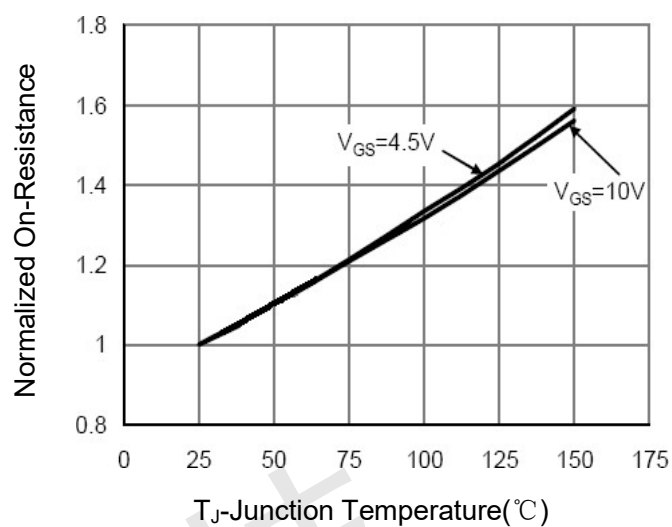

Figure 8 Rdson vs Junction Temperature

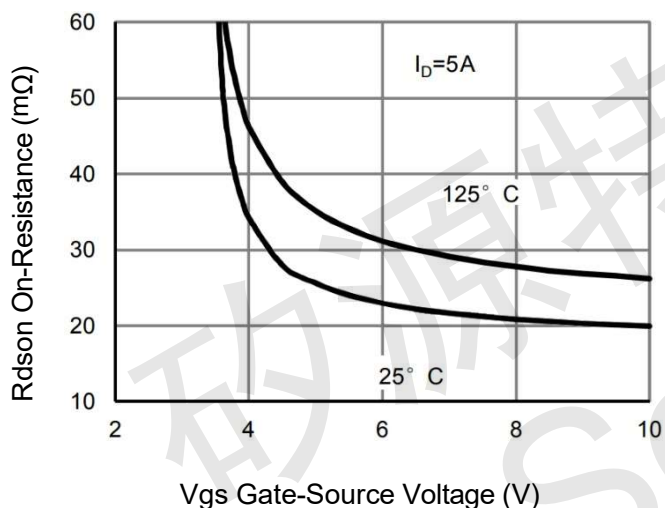

Figure 9 Rdson vs Vgs

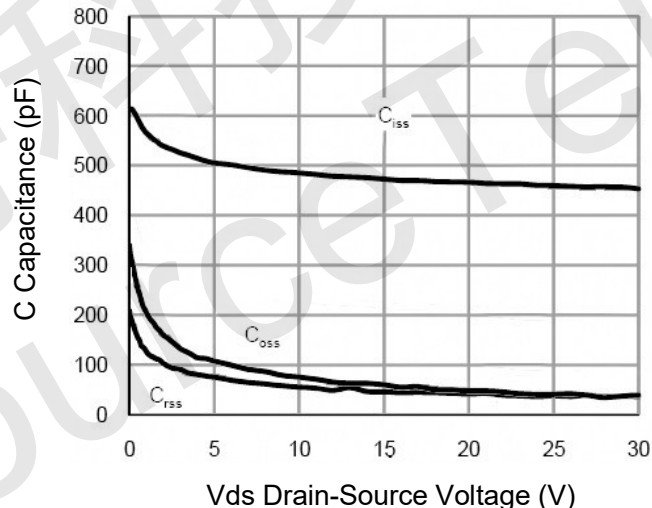

Figure 10 Capacitance vs Vds

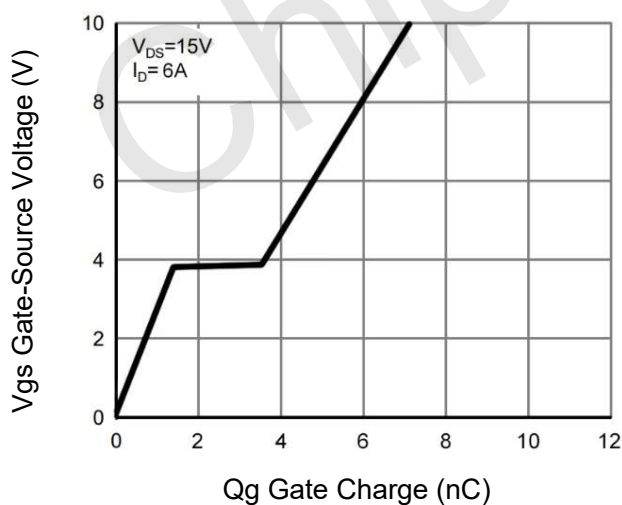

Figure 11 Gate Charge

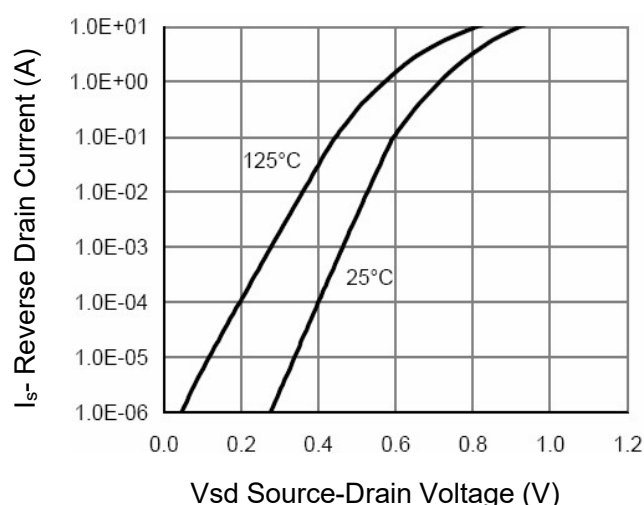

Figure 12 Source- Drain Diode Forward

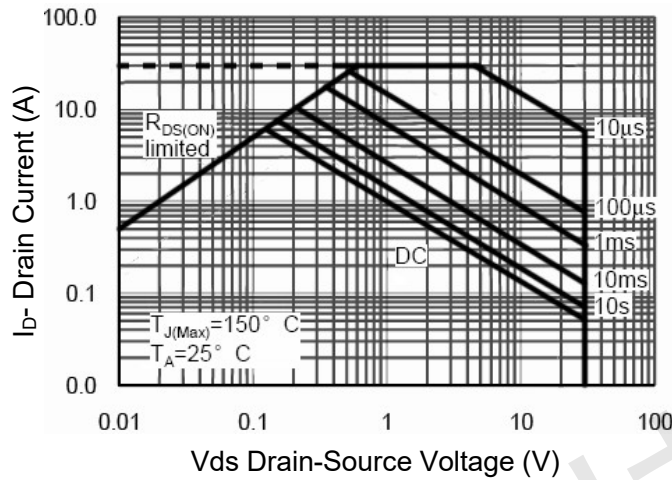

Figure 13 Safe Operation Area

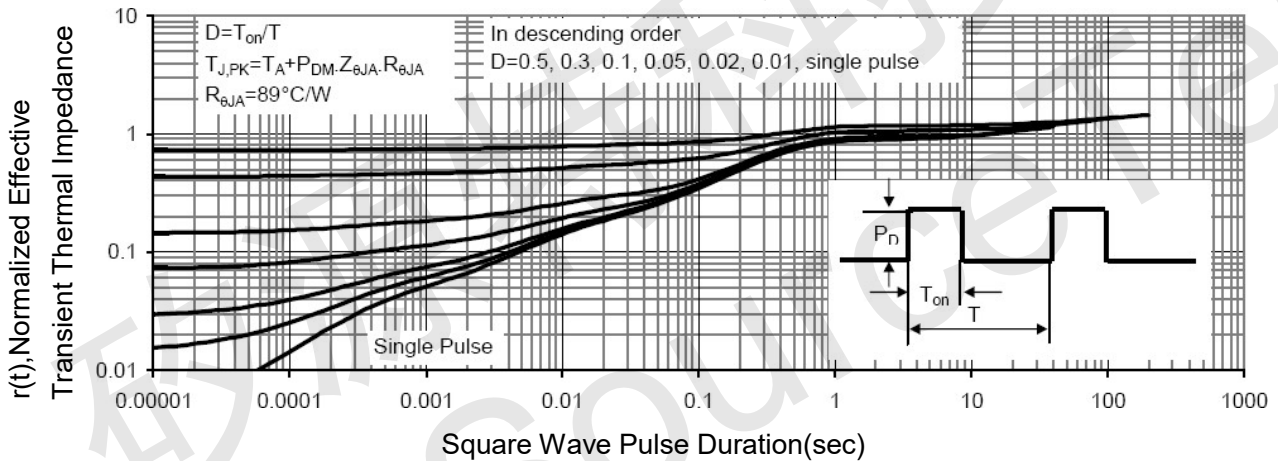
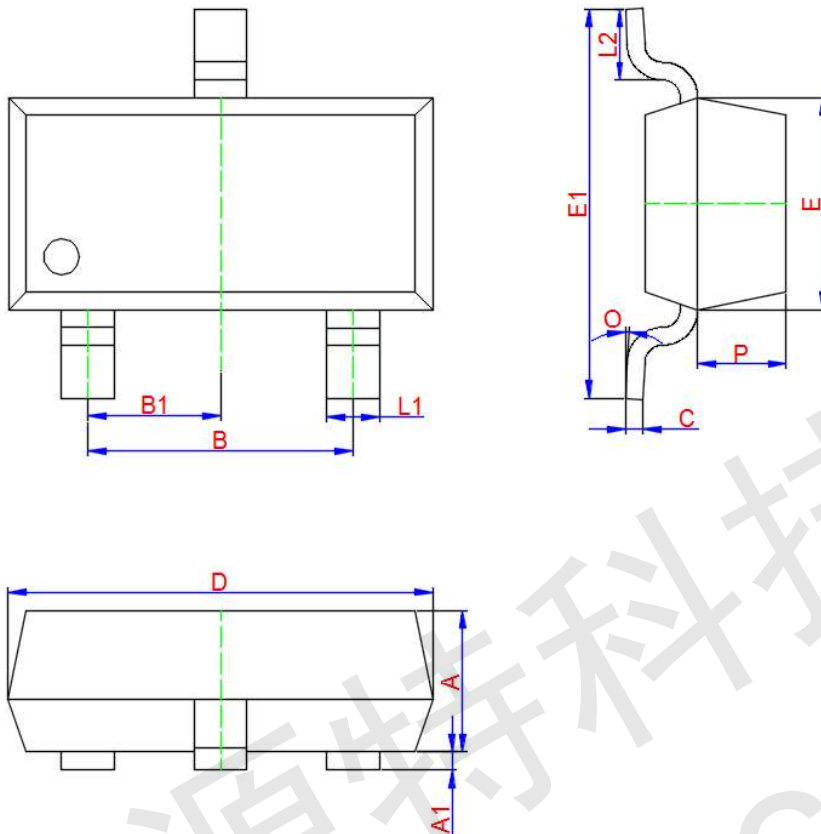

Figure 14 Normalized Maximum Transient Thermal Impedance



SOT-23 Package Information



Symbol	Dimensions In Millimeters		
	Min.	Typ.	Max.
A	0.900	1.000	1.100
A1	0.000	0.050	0.100
L1	0.300	0.400	0.500
C	0.100	0.110	0.120
D	2.800	2.900	3.000
E	1.250	1.300	1.350
E1	2.250	2.400	2.550
B	1.800	1.900	2.000
B1	0.950 TYP.		
L2	0.200	0.350	0.450
P	0.550	0.575	0.600
O	0°	4°	8°