

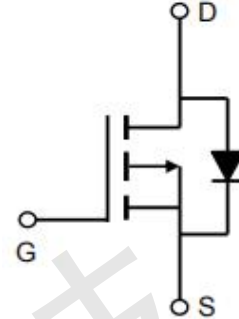

P-Channel Enhancement Mode Power MOSFET

Description

The MX4407 uses advanced trench technology to provide excellent $R_{DS(ON)}$, low gate charge and operation with gate voltages as low as 4.5V. This device is suitable for use as a load switch or in PWM applications.



General Features

- $V_{DS} = -30V, I_D = -12A$
- $R_{DS(ON)} < 15m\Omega @ V_{GS} = -10V$
- $R_{DS(ON)} < 25m\Omega @ V_{GS} = -4.5V$
- High Power and current handling capability
- Lead free product is acquired
- Surface mount package

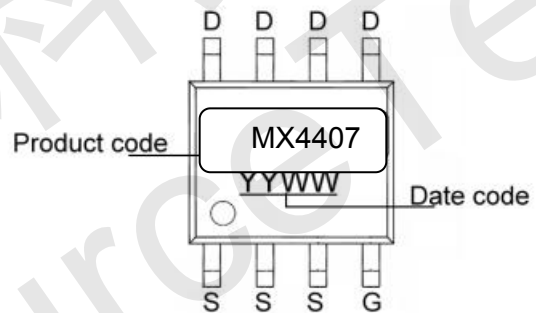

Application

- PWM applications
- Load switch
- Power management

Parameter	Symbol	Limit	Unit
Drain-Source Voltage	V_{DS}	-30	V
Gate-Source Voltage	V_{GS}	± 20	V
Drain Current-Continuous	I_D	-12	A
Drain Current-Pulsed (Note 1)	I_{DM}	-48	A
Maximum Power Dissipation	P_D	3	W
Operating Junction and Storage Temperature Range	T_J, T_{STG}	-55 To 150	$^{\circ}C$

Absolute Maximum Ratings ($T_A = 25^{\circ}C$ unless otherwise noted)

Thermal CharacteristicE

Thermal Resistance, Junction-to-Ambient (Note 2)	$R_{\theta JA}$	41.67	$^{\circ}C/W$
--	-----------------	-------	---------------



Electrical Characteristics (T_A=25°C unless otherwise noted)

Parameter	Symbol	Condition	Min	Typ	Max	Unit
Drain-Source Breakdown Voltage	BV _{DSS}	V _{GS} =0V, I _D =-250μA	-30	-33	-	V
Zero Gate Voltage Drain Current	I _{DSS}	V _{DS} =-30V, V _{GS} =0V	-	-	-1	μA
Gate-Body Leakage Current	I _{GSS}	V _{GS} =±20V, V _{DS} =0V	-	-	±100	nA
On Characteristics (Note 3)						
Gate Threshold Voltage	V _{GS(th)}	V _{DS} =V _{GS} , I _D =-250μA	-1	-1.5	-3	V
Drain-Source On-State Resistance	R _{Ds(ON)}	V _{GS} =-10V, I _D =-10A	-	11.5	15	mΩ
		V _{GS} =-4.5V, I _D =-7A	-	18	25	mΩ
Forward Transconductance	g _{FS}	V _{DS} =-10V, I _D =-10A	20	-	-	S
Dynamic Characteristics (Note 4)						
Input Capacitance	C _{iss}	V _{DS} =-15V, V _{GS} =0V, F=1.0MHz	-	1750	-	PF
Output Capacitance	C _{oss}		-	215	-	PF
Reverse Transfer Capacitance	C _{rss}		-	180	-	PF
Switching Characteristics (Note 4)						
Turn-on Delay Time	t _{d(on)}	V _{DD} =-15V, I _D =-10A, V _{GS} =-10V, R _{GEN} =1Ω	-	9	-	nS
Turn-on Rise Time	t _r		-	8	-	nS
Turn-Off Delay Time	t _{d(off)}		-	28	-	nS
Turn-Off Fall Time	t _f		-	10	-	nS
Total Gate Charge	Q _g	V _{DS} =-15V, I _D =-10A, V _{GS} =-10V	-	24	-	nC
Gate-Source Charge	Q _{gs}		-	3.5	-	nC
Gate-Drain Charge	Q _{gd}		-	6	-	nC
Drain-Source Diode Characteristics						
Diode Forward Voltage (Note 3)	V _{SD}	V _{GS} =0V, I _S =-2A	-	-	-1.2	V

Notes:

1. Repetitive Rating: Pulse width limited by maximum junction temperature.
2. Surface Mounted on FR4 Board, t ≤ 10 sec.
3. Pulse Test: Pulse Width ≤ 300μs, Duty Cycle ≤ 2%.
4. Guaranteed by design, not subject to production



Typical Electrical and Thermal Characteristics

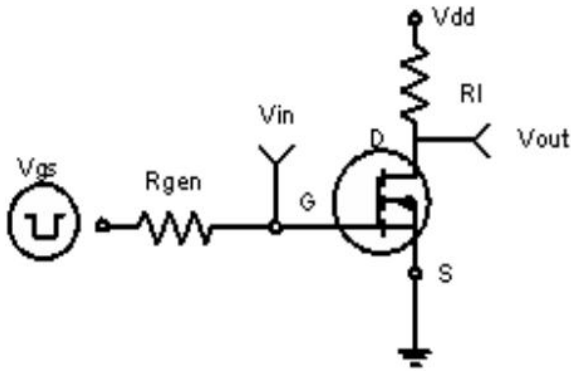

Figure 1: Switching Test Circuit

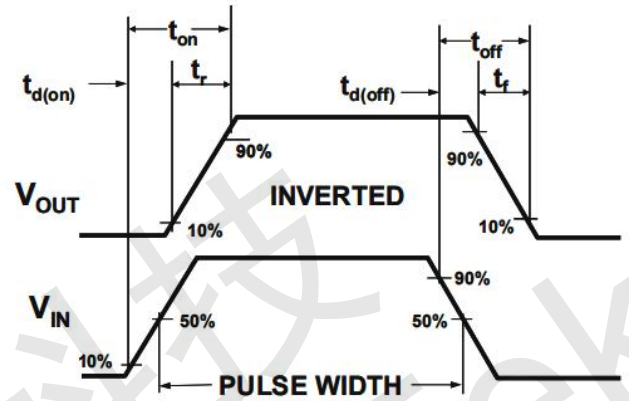

Figure 2: Switching Waveforms

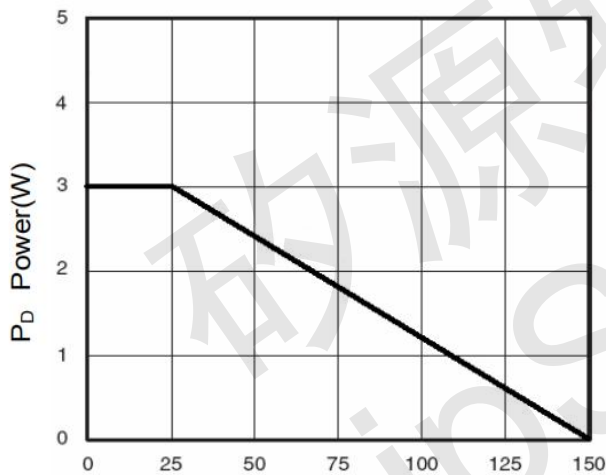

Figure 3 Power Dissipation

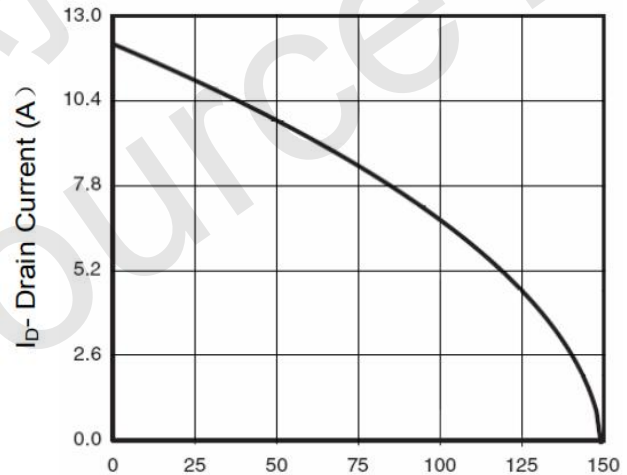

Figure 4 Drain Current

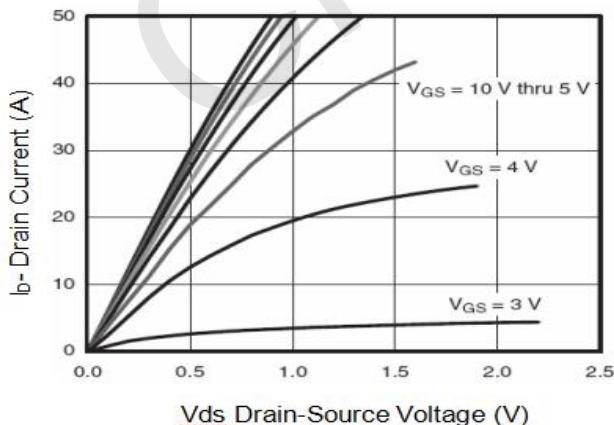

Figure 5 Output Characteristics

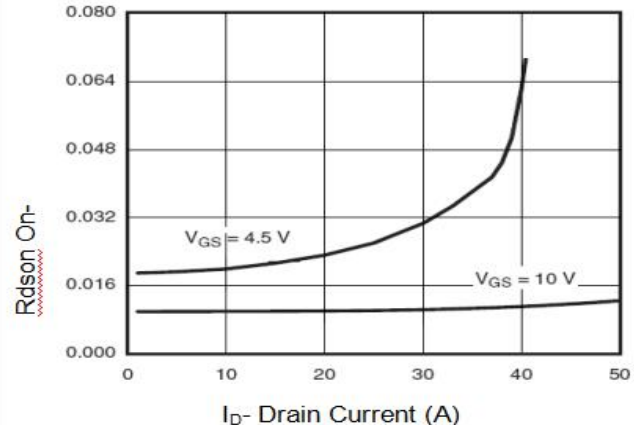
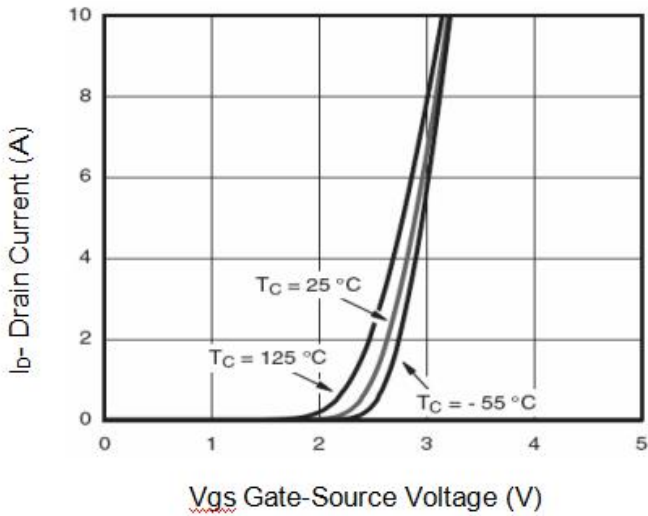
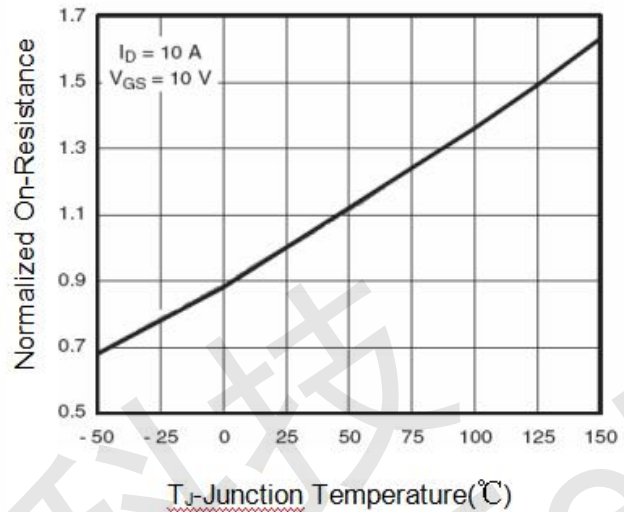

Figure 6 Drain-Source On-Resistance



Vgs Gate-Source Voltage (V)
Figure 7 Transfer Characteristics



TJ-Junction Temperature(°C)
Figure 8 Drain-Source On-Resistance

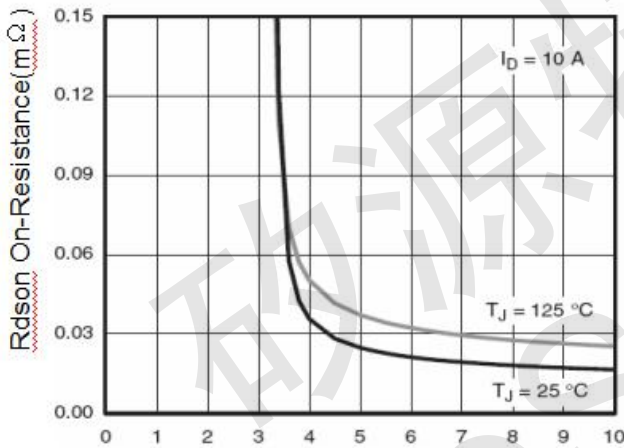

Vgs Gate-Source Voltage (V)
Figure 9 Rdson vs Vgs

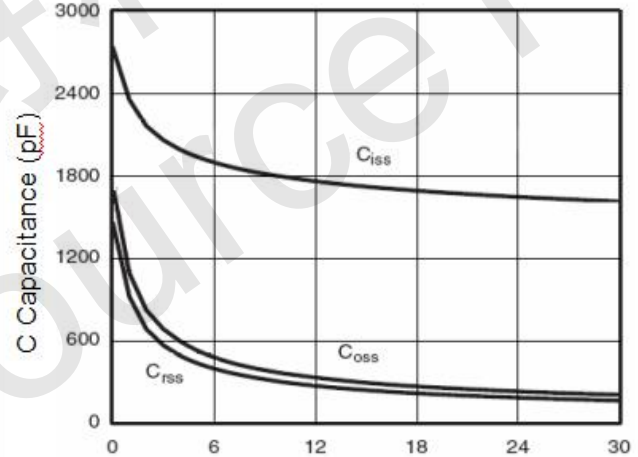

Vds Drain-Source Voltage (V)
Figure 10 Capacitance vs Vds

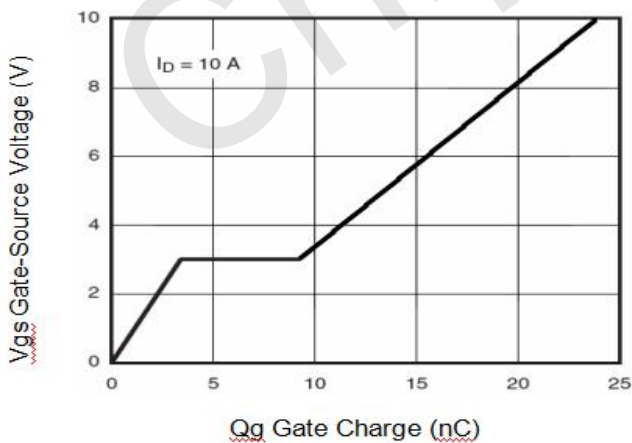

Qg Gate Charge (nC)
Figure 11 Gate Charge

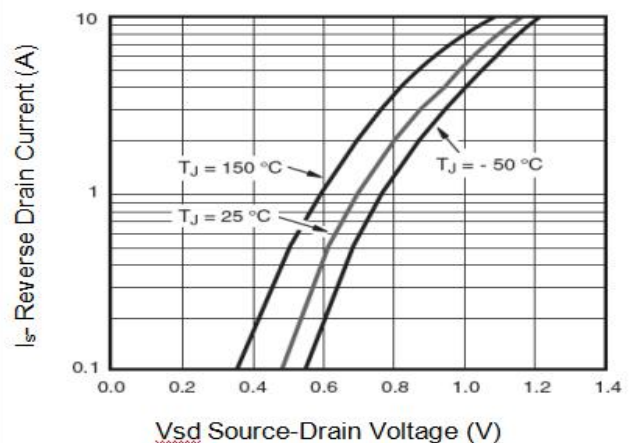

Vsd Source-Drain Voltage (V)
Figure 12 Source-Drain Diode Forward

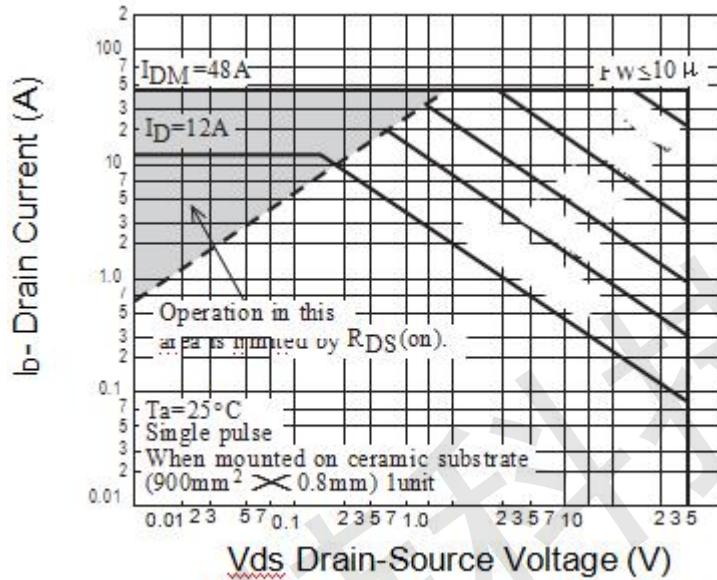

Figure 13 Safe Operation Area

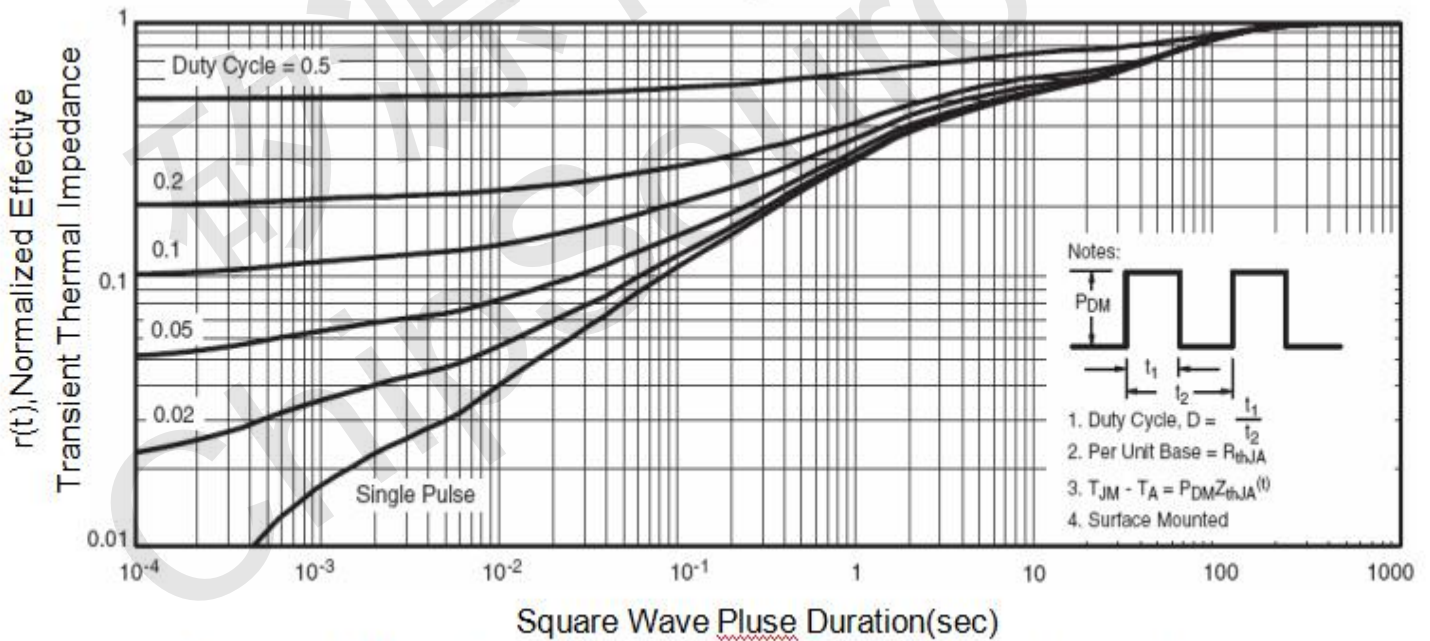
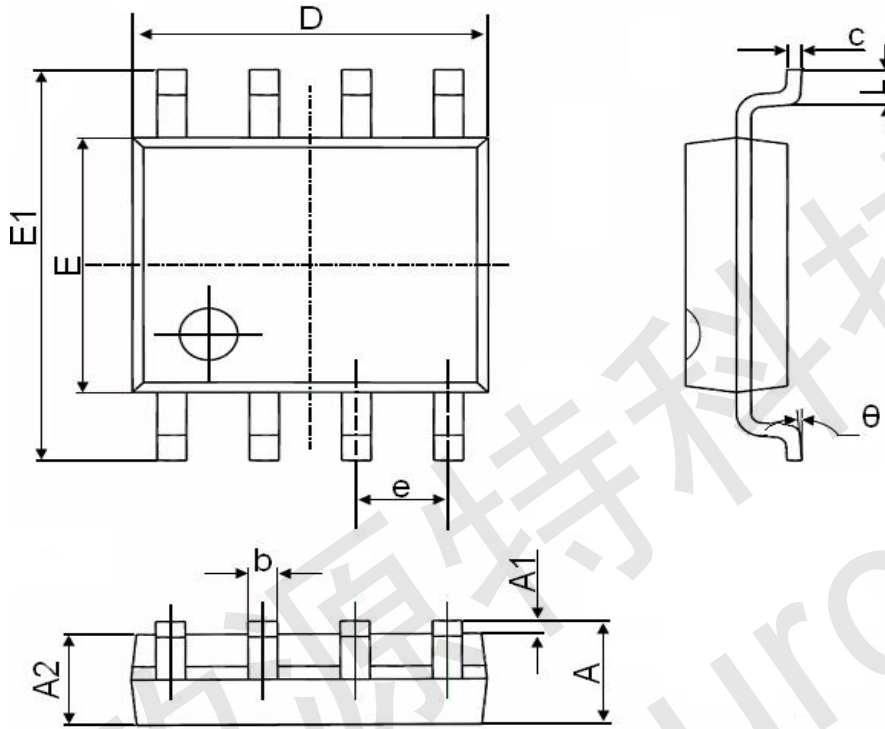

Figure 14 Normalized Maximum Transient Thermal Impedance



SOP-8 Package Information



Symbol	Dimensions In Millimeters		Dimensions In Inches	
	Min.	Max.	Min.	Max.
A	1.350	1.750	0.053	0.069
A1	0.100	0.250	0.004	0.010
A2	1.350	1.550	0.053	0.061
b	0.330	0.510	0.013	0.020
c	0.170	0.250	0.006	0.010
D	4.700	5.100	0.185	0.200
E	3.800	4.000	0.150	0.157
E1	5.800	6.200	0.228	0.244
e	1.270(BSC)		0.050(BSC)	
L	0.400	1.270	0.016	0.050
θ	0°	8°	0°	8°